

**ASSEMBLY INSTRUCTIONS**  
**INSTRUCTIONS DE MONTAGE**  
**INSTRUCCIONES DE ENSAMBLAJE**

**2461, 2463**  
**CHA - CHA™**

**X- Style Base for Cha-Cha Tables**

*X-Style Base pour des Tableaux de Cha-Cha ;*

*X- Estilo Base para las Tablas de Cha-Cha;*

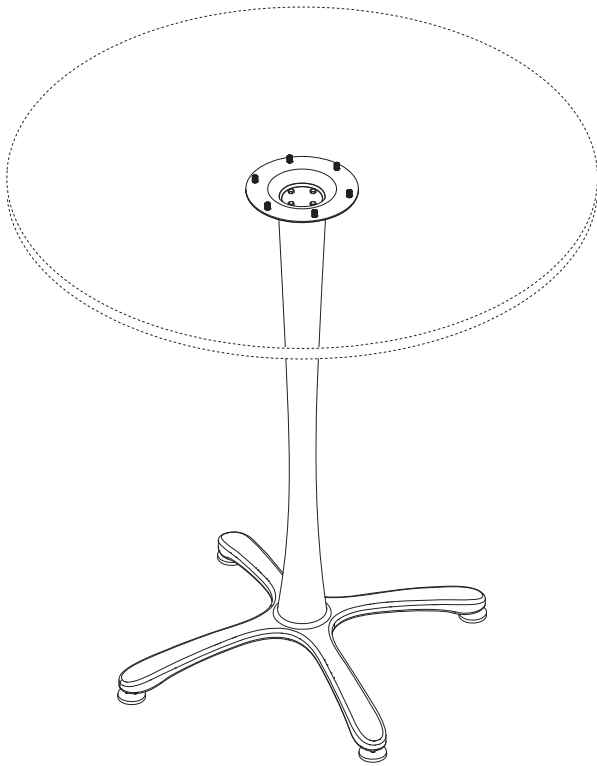

**Base with 42" Round Table Top**

*Base avec une ronde table surface de 107cm*

*Base con el 42 pulg tablero de la mesa ronda*

**Also available but not shown:**

**oval, rectangular and peninsula styles with dual bases**

*Aussi disponible mais non affiché:*

*styles ovale, rectangulaire et la péninsule avec des bases doubles*

También está disponible pero no se muestran:

estilos oval, rectangular y de la península con las bases de dos

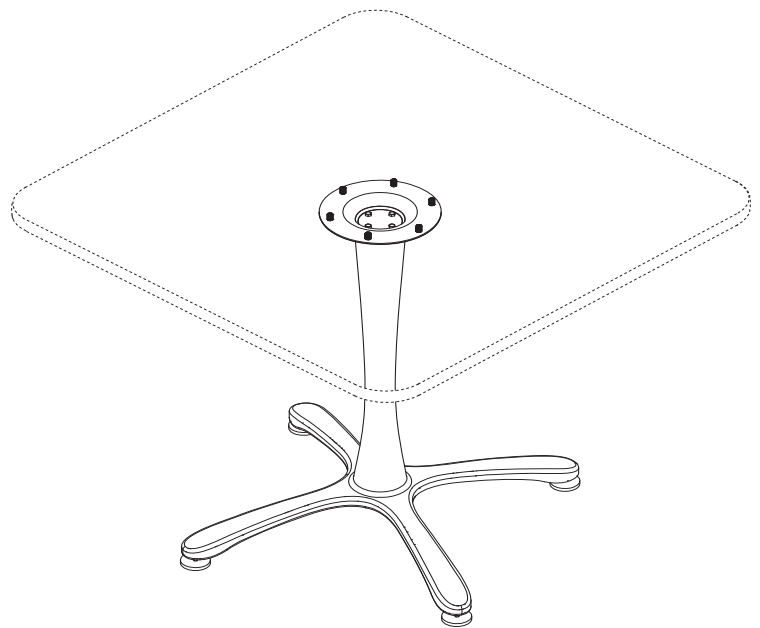

**Base with 36" Square Table Top**

*Base avec une carré table surface de 91cm*

*Base con el 36 pulg tablero de la mesa  
cuadrado*

**PRODUCT WARRANTY REGISTRATION** is available online at: [www.safcoproducts.com](http://www.safcoproducts.com)

• L'INSCRIPTION POUR LA GARANTIE DU PRODUIT est disponible sur l'Internet : [www.safcoproducts.com](http://www.safcoproducts.com)

• EI REGISTRO PARA LA GARANTÍA DEL PRODUCTO está disponible en la Internet: [www.safcoproducts.com](http://www.safcoproducts.com)

For questions or concerns, please call **1-800-664-0042**  
available Monday-Friday 7:00 AM to 6:00 PM (Central Time) (English-speaking operators)

Si vous avez des questions pour poser ou les préoccupations pour exprimer, connecter **au 1-800-664-0042** de 7H00 à 18H00 (Heure centrale) (Opérateurs de langue anglaise)

Si usted tiene preguntas o preocupaciones, por favor llame **1-800-664-0042** de 7:00 AM a 6:00 PM (Hora Central) (Operadores que hablan inglés)

# TOOLS REQUIRED: Allen Wrench (included), Phillips Screwdriver





## PARTS LIST

CODE	DESCRIPTION	QTY	PART NO.
(A)	Top Plate	1	2461-01§
(B)	Central Tube	1	
	Seat Height, Tube		2461-03§, †
	Bar Height, Tube		2461-02§, †
(C)	X-Style Base	1	2461-04§

§Note: When corresponding about parts, be sure to state color: Black (BL), Tan (TN) or Metallic Gray (SL).

†Note: When corresponding about parts, be sure to state; Seat Height Tube, or Bar Height Tube.

Oval, rectangle and peninsula tops require two bases; double the quantities and steps as necessary

HARDWARE PACK 2461-19NC	
<b>D</b>  Cap Screw Qty.: 8 #2461-22NC	<b>E</b>  Leveler Qty.: 4 #2461-23NC
<b>F</b>  PFH Screw Qty.: 6 #2050-24NC	<b>G</b>  Allen Wrench Qty.: 1 #2050-33NC

# OUTILS REQUIS : Clef Allen (incluse), Tournevis à pointe cruciforme





## LISTE DES PIÈCES

CODE	DESCRIPTION	QUANTITÉ	N° DE PIÈCE
(A)	Sommet plate-forme	1	2461-01§
(B)	Centre tuyau	1	
	Petit tuyau		2461-03§, †
	Long tuyau		2461-02§, †
(C)	X-Style socle	1	2461-04§

§Noter: Quand correspondre au sujet de parties, soyez sûr d'affirmer la couleur: Noir (BL), Marron Clair (TN) ou Gris Métallique (SL).

†Noter: Quand correspondre au sujet de parties, soyez sûr d'affirmer; Petit tuyau, ou Long tuyau.

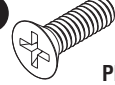
Surfaces ovale, rectangle et la péninsule besoin de deux bases; doubler les quantités et les étapes nécessaires

PAQUET MATÉRIEL 2461-19NC	
<b>D</b>  Vis à pastille Qte.: 8 #2461-22NC	<b>E</b>  Niveleur Qty.: 4 #2461-23NC
<b>F</b>  PFH vis Qte.: 6 #2050-24NC	<b>G</b>  Clef Allen Qty.: 1 #2050-33NC

# HERRAMIENTAS REQUERIDAS: Llave Allen (incluida), Destornillador Phillips®





## LISTA DE PIEZAS

CODIGO	DESCRIPCIÓN	CANTIDAD	NO. DE PIEZA
(A)	Placa superior	1	2461-01§
(B)	Centre tubo	1	
	Tubo corto		2461-03§, †
	Tubo largo		2461-02§, †
(C)	X-Estilo de base	1	2461-04§

§Note: Al corresponder sobre las piezas, esté seguro declarar el color: Negro (BL), Marrón Claro (TN) o Gris Metálico (SL).

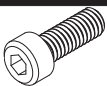
†Note: Al corresponder sobre las piezas, esté seguro declarar; tubo corto, or tubo largo.

Tableros de óvalo, rectángulo y la península requieren dos bases, el doble de las cantidades y medidas que sean necesarias

PAQUETE MATERIAL 2461-19NC	
<b>D</b>  Tornillo roscado Cant.: 8 #2461-22NC	<b>E</b>  Nivelador Qty.: 4 #2461-23NC
<b>F</b>  Tornillo PFH Cant.: 6 #2050-24NC	<b>G</b>  Llave Allen Cant.: 1 #2050-33NC

**Table top sold separately**  
*Table surface se vendre séparément*  
Tapa de tabla se vende por separado

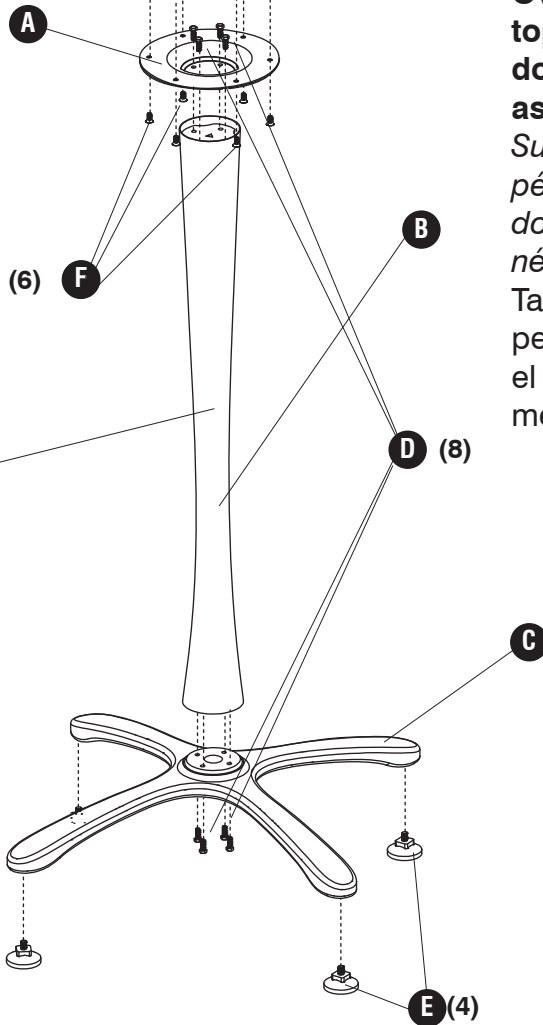
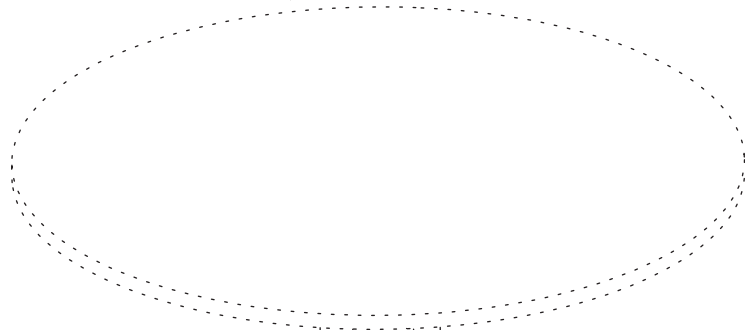

**Oval, rectangle and peninsula tops require two bases; double the quantities and steps as necessary**

*Surfaces ovale, rectangle et la péninsule besoin de deux bases; doubler les quantités et les étapes nécessaires*

Tableros de óvalo, rectángulo y la península requieren dos bases, el doble de las cantidades y medidas que sean necesarias

**Shown with Bar height tube**  
*indiqué avec le long tuyau*  
se muestra con tubo largo

1

D

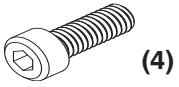

E

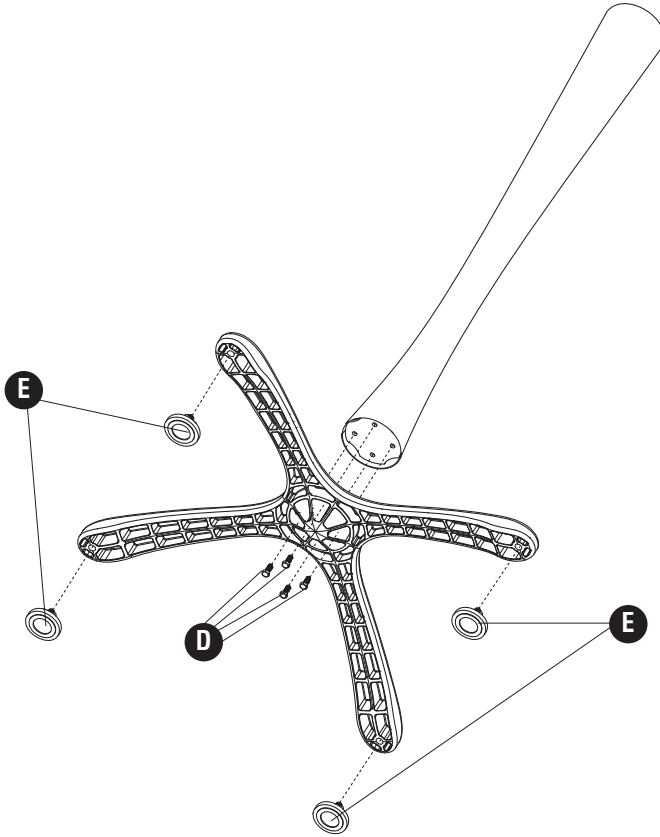
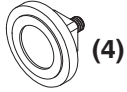

2

D

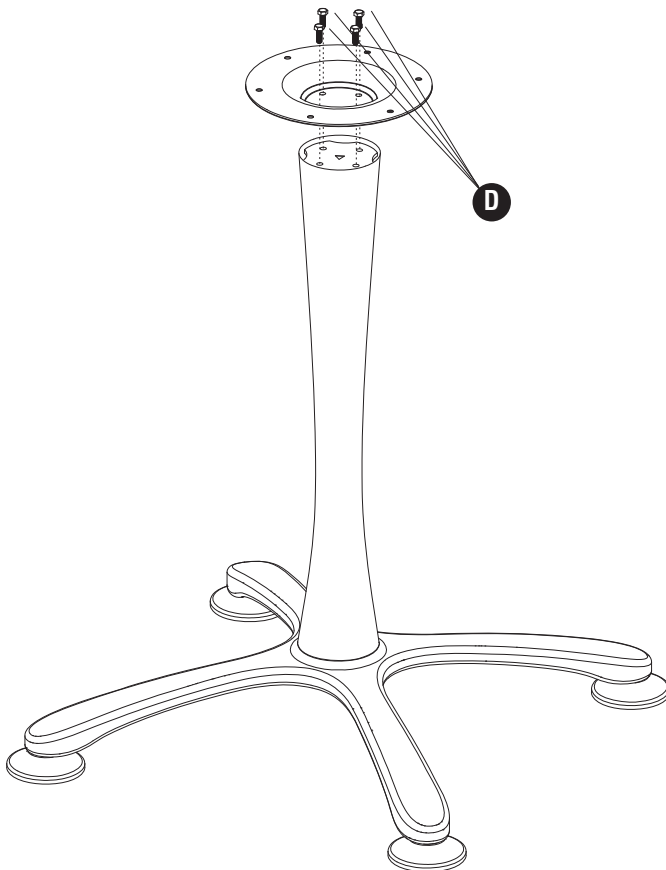
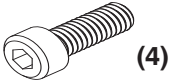

**3** **F** (6)

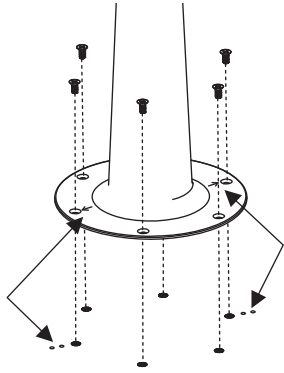

**NOTE:** When placing base on square top, align arrows on mounting plate with double dots on underside of top, so that base legs will align to corners of top. Arrows can be on either side of plate.

*NOTER:* Si vous utilisez table carré, aligner les flèches sur la plaque de montage avec des points doubles sur la face de dessus, de sorte que les jambes de base s'alignera aux quatre coins du haut. Les flèches peuvent être de chaque côté de la plaque.

*NOTA:* Si utilizando un tablero cuadrado, alinear las flechas en la placa de montaje con puntos dobles en la parte inferior de la superior, por lo que las piernas de base se alinean con las esquinas de la parte superior de la tabla. Las flechas pueden ser de cualquier lado de la placa.

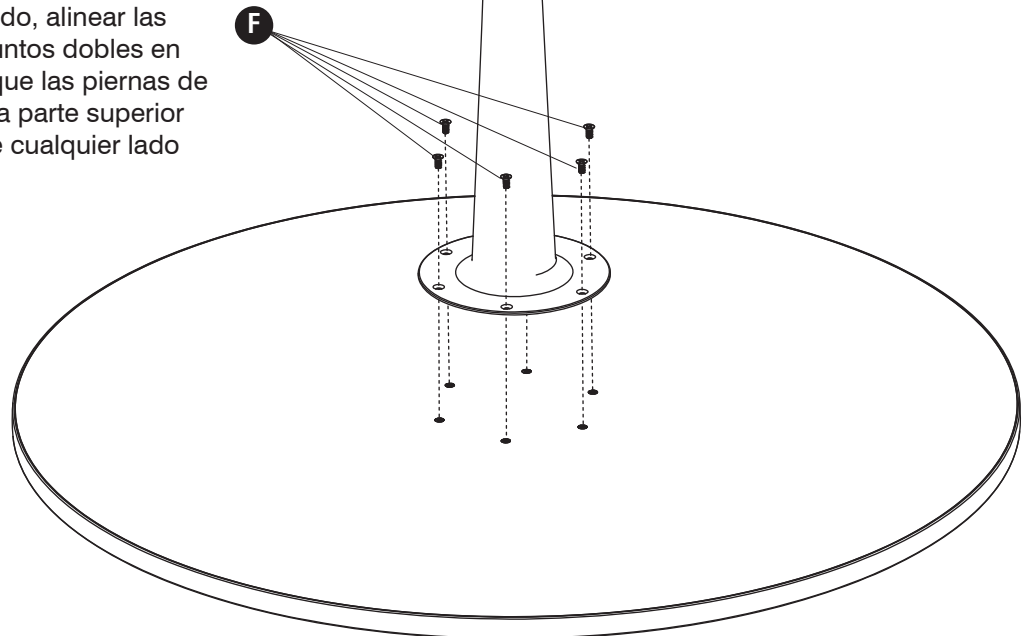
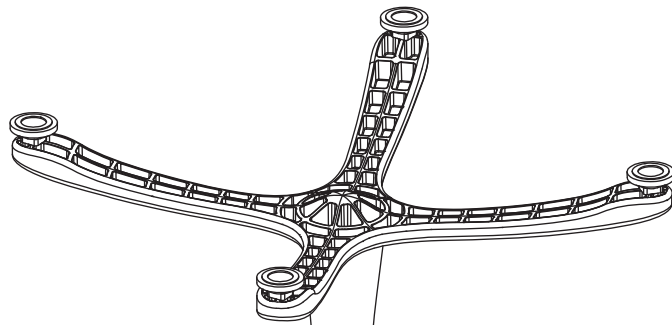
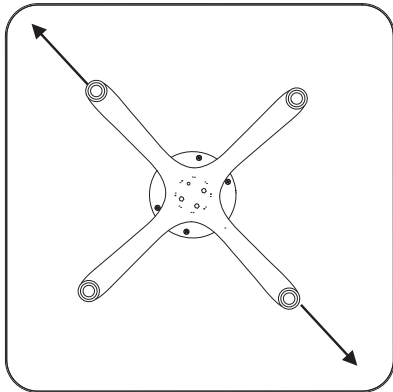

**For oval, rectangle and peninsula tops requiring two bases: see the mounting instructions that are supplied with your top**

*Pour surfaces ovale, rectangle et la péninsule nécessitant deux bases: voir les instructions de montage qui sont fournies avec votre surface*

*Para tableros de óvalo, rectángulo y la península que requiere dos bases: consulte las instrucciones de montaje que se suministran con su tablero*