

**SAFCO<sup>®</sup>**

# **PRICE LIST**

2023

Price Effective July 6, 2022

# Our Locations

Safco® is excited to provide you with a variety of workspace solutions that will help make your workday easier, more comfortable and hopefully a little more fun. We're ready with an assortment of Quick Ship options and a robust service offering that will make us easier to do business with than ever before. So, read on and let us tell, and then show you how we can help with all your workspace needs.

## Our Locations

Our distribution centers, manufacturing facilities and showrooms create a network built to provide a fast and easy customer experience.

### Distribution Centers (DC's)

Our DC's give us the ability to ship our most popular Quick Ship products from a location near you. Need to know exactly where your product is shipping from? Simply contact our expert Customer Care team for a speedy answer to this and all of your Safco questions – even the ones you didn't know you had. Safco DC's are located in:

Windsor, VA  
Riverside, CA

### Showrooms

If you would like to see our products in-person we have two showroom locations filled with a variety of our products. If one of these locations doesn't fit into your travel schedule, simply let us know and we can direct you to one of our Rep Group partners' showrooms that are located throughout North America. Safco Showrooms are located in:

Milford, IA  
Chicago, IL (Merchandise Mart)

### Manufacturing Facilities

Safco has a state-of-the-art manufacturing facility in Milford, IA. This plant allows us to build our legacy products more effectively and enable new product design for the future. Our Kennesaw, GA facility is a light manufacturing plant where all of our configured and custom upholstery seating is produced and our lockers are built. Safco manufacturing facilities are located in:

Milford, IA  
Kennesaw, GA

### Headquarters

Last, but certainly not least, is our headquarters in New Hope, MN (Minneapolis). This is where your orders get placed, calls and emails get answered, products designed, and marketing materials are produced. It's the place Safco calls home and where we will be waiting for your call should you need our assistance.

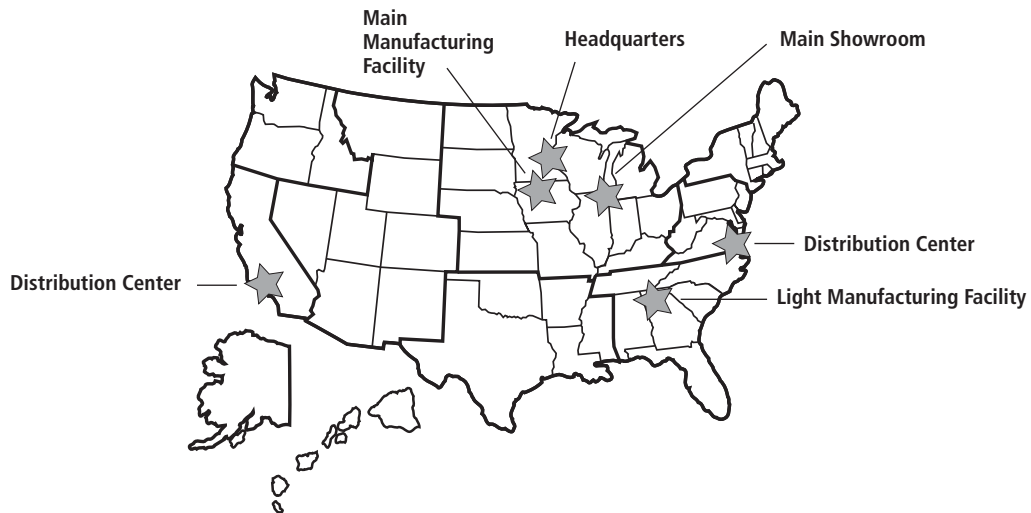

## Space Planning Services

Our team of space planning experts provide workspace and storage solution designs that include our entire product offering. Plus, our design renderings showcase how Safco products will fit into your space and bring in color and textures so you can see what your space will look like – making guesswork a thing of the past. If you have any space planning questions, contact [spaceplanning@safcoproducts.com](mailto:spaceplanning@safcoproducts.com) or your local Safco Sales Rep Group.

## Installation Services

Now you need someone to install all that great Safco product. We have you covered there as well. Go to our website and select "Find a Certified Installer" to find the best option for all your Safco installation needs. But we don't stop there. Our in-house Installation Manager will help with any questions to ensure your project goes smoothly from the time your product arrives until every last piece of hardware is in place.

## 48 Hour Quick Ship

What exactly is 48 Hour Quick Ship? 48 Hour Quick Ship means that items in this book identified with the  'Ships Within 48 Hours icon' will ship from one of our DC's within 48 hours of a complete Purchase Order being sent. Now you may be wondering what a complete Purchase Order means; It simply means it has all the information we need to submit an order such as color and feature choices, quantity, shipping information, etc. are present and accounted for.

- All dimensions shown in this publication are nominal.
- All illustrations and specifications in this publication are based on the latest product information available at date of publication.
- **Prices are subject to change without notice.** All orders are subject to prices in effect at the time of order.
- Safco Limited Lifetime Warranty applies unless otherwise noted.

Office Suites  
Seating  
Tables & Desks  
Meeting Essentials  
Personal Organization  
Ergonomics  
High Density Storage  
Storage & Filing  
Facilities  
Technology Furniture  
Art & Engineering  
K-12 Education  
SAFE Collection Addendum

**DEFINITION:**

Special Pricing is an additional discount from standard net pricing granted for a specific customer to be used on an identified project in a defined period of time, generally 90 days. Unless previously approved by Safco®, it will be for one purchase order and shipping to one location in a single shipment.

**PURPOSE:**

Special Pricing is extended to our Dealers at the sole discretion of Safco primarily for the purposes of improving our price position in competitive situations. It is understood that the basis for Special Pricing consideration is information that is gathered from our Dealers and Sales Representatives as well as our historical data. To this extent, it is critical that the information supplied by our Dealers and Sales Representatives is complete, accurate and timely.

**GUIDELINES:**

Requests will be considered on competitive projects of \$25,000 list and above. Discretion will be employed for high quantities of lower list price items, or with a specific strategic objective in mind. Safco reserves the right to deny or award requests for Special Pricing at any time to any Dealer.

**PROCEDURE:**

Safco processes Special Pricing requests on a first in, first out basis. Incomplete data will prevent us from processing the request and it will be returned to the Dealer or Sales Representative for completion prior to processing. We strive to provide fast responses to requests, and generally do so within 24 hours. Please allow more time, if possible. To request the Special Pricing Request Form, you may email your request to [bids@safcoproducts.com](mailto:bids@safcoproducts.com) or contact your Sales Representative.

The Special Pricing Request Form may be submitted electronically by emailing to [bids@safcoproducts.com](mailto:bids@safcoproducts.com), or faxed to us at the number on the form. Electronic submission is preferred whenever possible. In special circumstances such as when traveling, computer breakdown, etc., we will process requests via phone, provided all information is complete, in order to provide you the best service possible.

**EXCLUSIONS:**

Special Pricing cannot be granted to Dealers solely for the purposes of improving margins in non-competitive circumstances, nor to place orders for stocked products. Once you have received the purchase order from your customer, Special Pricing requests for that project can no longer be processed. We reserve the right to request a copy of the purchase order from your customer for the purposes of confirming integrity of the process.

By requesting Special Pricing, Dealers and Sales Representatives confirm that they intend to, and will make reasonable efforts to sell the Safco products listed in the Special Pricing request to the named customer. If a Dealer or Sales Representative obtains Special Pricing for the purpose of competitively submitting an alternative competitive product to their customer, Special Pricing requests for that Dealer will be suspended indefinitely at Safco's sole discretion.

**ORDER SUBMISSION:**

In order for Special Pricing to be applied to the appropriate order, the order must reference the Bid Number supplied by Safco at the time of order placement. Failure to include the bid number will prevent Safco order entry from placing your order with the appropriate Special Pricing discount applied; standard discounts will then be used. Credits cannot be issued after Safco order entry has entered your order.

**SPIRIT OF COOPERATION:**

Safco appreciates the opportunity to partner with our Dealers and Sales Representatives in order to enjoy mutual business. It is our pledge to you to make every interaction as productive, fair, and enjoyable as possible. We sincerely appreciate your business and look forward to the many opportunities to work together in the future.

**SETTING UP AN ACCOUNT WITH SAFCO**

**Becoming a Dealer/Distributor**

Grow with Us! Simply visit [www.safcoproducts.com](http://www.safcoproducts.com) to apply for Dealership/Distributorship.

**FREIGHT POLICY - Effective January 3, 2022**

**FREIGHT**

Prepaid on all orders of \$1,500 Net or more.  
Orders less than \$1,500 Net:  
LTL: \$150 Flat rate  
Small Parcel: \$25 Flat rate  
Orders containing both LTL and small parcel: \$150 flat rate





Special routing request fees for LTL (Accessorial Charges):

- Call before Delivery – Included. Please specify at order entry.
- Lift Gate Assistance – \$125 for orders requiring a lift gate (no loading dock).
- Inside Delivery – \$50 for delivery to threshold only of first door.
  - Does not include put in place, un-carton, assembly, or trash removal.
  - Local restrictions may apply.
- Additional redelivery or storage charges may apply if special routing requests are not specified ahead of time and additional trips are required.
- Contact Customer Service at [info@safcoproducts.com](mailto:info@safcoproducts.com) for a quote on Expedited Service (guaranteed date and time of delivery), or larger volume orders or special services requested over 2,000 lbs.
- Safco is not responsible for issues or costs arising from carrier transit delays, missed delivery appointments, etc.

**MINIMUM ORDERS**

No minimum order requirement, however, all orders must be placed in full carton quantities.

**THE FOLLOWING ICONS ARE USED THROUGHOUT THIS PUBLICATION:**

 <b>NEW</b> New Product	 Ships Within 48 Hours	 Shippable by Small Package Carrier
	 Meets ANSI/BIFMA Standards	 PROP 65 Warning

Our warranty pledges excellence in the quality of our products. It helps protect our customer's investments and extends our continuing dedication to our customers after their initial investment.

## LIMITED LIFETIME WARRANTY

Safco® warranty obligation: We pledge to repair or replace, at Safco's option, any Safco product or component that is defective in material or workmanship for as long as you, the original purchaser, own it. This warranty is subject to the provisions below.

## LIABILITY LIMITATIONS

The following listed parts, components and supplies are covered under warranty in accordance with the below schedule following the product purchase date.

**Ten Years:** Seating controls and cylinders, Rumba™, Cha-Cha™, electric height-adjustable table series laminates, and wood seating components. All parts (excluding motor) on the XR, ML and E Series Height-Adjustable Tables.

**Five Years:** Glides, casters, polymer-based components, seating upholstery (fabrics and leather), foam, armrests, chrome seating components, user-adjustable work surface mechanisms, laminates, veneer finishes and other covering materials, drawer glides, electrical components, cabinets or mobile systems, components that are either moving parts or controls (guides that are in contact with moving parts), and motors on the ML-Series, E-Series, and XR-Series Height-Adjustable Tables.

**Three Years:** Outdoor Products (Evos™, Canneleon™ and CoGo™ Product Lines), High Density 4-Post wire shelving and wire components, and electrical components, Dry Erase Surfaces.

## WARRANTY SUBJECT TO EXCLUSIONS

Exclusions pertaining to this warranty are as follows but are not limited to:

- Normal wear and tear
- Product or product components utilized with the intent to rent or lease
- Freight damages: Safco is not liable for any product damages sustained during shipping or handling operations. Safco provides specific policies and requirements regarding shipping and handling, and reserves the right to review and address product distribution matters separately.
- Product negligence: A product is not considered defective due to misuse or improper installation. Safco products must be installed, used and maintained in accordance with product instructions and warnings.
- Alterations or attachments to the product that were not approved by Safco
- All COM Fabric is not covered under this warranty
- All corrugated products or components
- Use of non-multiple shift products for multiple shifts
- Products purchased through a discontinued products promotion/liquidation

Safco's warranty obligation is limited to normal use upon receipt of our products.

## SEATING USAGE

Normal commercial usage for seating is defined as the equivalent of a single shift, forty (40) hour work week. To the extent that a seating product is used in a manner exceeding this, the applicable warranty period will be reduced in a pro-rata manner.

Models warranted for multiple shifts:

- Task Master® Industrial Series
- Soft Tough™ Series
- WorkFit™ Polyurethane Series
- Uber™ Series (500 lbs.)
- Alday™ Intensive-Use (500 lbs.)
- Vue™ Intensive-Use (500 lbs.)

## WARRANTY PROCEDURES

Please follow the warranty procedures described below:

1. Once a defect has been discovered, the original purchaser must contact Safco® immediately (within 30 days of defect detection), in writing, with the serial number(s) (if applicable), date code and model number from the product(s) in question.
2. Upon inspection of the product(s), Safco® will collect all relevant information necessary for review of the request.
3. Product replacement and replacement parts will be authorized by a Customer Care representative if acknowledged to be necessary under product warranty eligibility conditions.

## SPECIFIC LIMITATIONS REGARDING COLOR VARIATIONS, FABRICS AND FINISHES

Natural products have varying grains and colors. Due to such natural variations occurring in materials such as wood and leather, these characteristics are not considered defects. Safco does not warrant the color-fastness or matching of colors, grains or textures of such materials. Materials supplied, selected or provided by the customer (COM) are not warranted.

Buyer is responsible for freight to and from factory on all warranty claims. Any description of the goods sold hereunder, including any reference to Buyer's specifications and any description in catalogs, circulars and other written or digital material published by Safco is for the sole purpose of identifying goods and shall not create an express or implied warranty that the goods shall conform to such description.

THERE ARE NO OTHER WARRANTIES, AND SAFCO DISCLAIMS ALL IMPLIED WARRANTIES INCLUDING WARRANTIES OF MERCHANTABILITY, FITNESS FOR A PARTICULAR PURPOSE AND FREEDOM FROM PATENT INFRINGEMENT. NO AGENT, EMPLOYEE OR REPRESENTATIVE OF SAFCO HAS ANY AUTHORITY TO BIND SAFCO TO ANY AFFIRMATION, REPRESENTATION OR WARRANTY EXCEPT AS STATED HEREIN.

SAFCO SHALL HAVE NO LIABILITY FOR INDIRECT, INCIDENTAL, CONSEQUENTIAL OR SPECIAL DAMAGES OF ANY KIND. THESE LIMITATIONS ARE AGREED ALLOCATIONS OF RISK. UNDER NO CIRCUMSTANCES SHALL SAFCO'S LIABILITY WITH REGARD TO THE SALE OR USE OF THE PRODUCTS EXCEED THE PURCHASE PRICE PAID BY THE BUYER FOR THE PRODUCTS. TERMS AND CONDITIONS OF THIS WARRANTY ARE SUBJECT TO CHANGE WITHOUT NOTICE.

Note: Safco® does not require the customer to fill out a warranty registration card. Please keep all purchase documents for the product in event the warranty is needed. Contact our Customer Care team for any warranty assistance at [info@safcoproducts.com](mailto:info@safcoproducts.com) or (888) 971-6225.



# Sales Policies

All orders with future ship dates will reflect current pricing within 90 days.

## CASH TERMS

1%-15 Net 30. For cash discount, remittance must be made 15 days following invoice date. Net amount due 30 days following invoice date.

## FACTORY RETURNS

All merchandise requesting to be returned must first be approved and issued a Return Goods Authorization (RGA) number. Except for defective merchandise, all factory returns must be shipped freight prepaid and are subject to a 25% recartoning/restocking charge which includes any charges for outgoing freight paid by Safco®.

We are unable to accept returns of any items not in the original cartoning, broken cartons and non-standard merchandise or in unsaleable condition. Return authorization label must be attached to return carton. Returns must be made within one (1) year in resalable condition, and in original Safco cartons. All product must be returned within 30 days of return authorization date or RGA will be cancelled.

Mobile Aisle™, Custom Upholstered Seating, 4-Post Shelving, all high-density filing products and Mailflow Systems® products are considered custom and cannot be returned. Please contact Customer Care at [info@safcoproducts.com](mailto:info@safcoproducts.com) or 888-971-6225 to receive a Return Goods Authorization number to include on each of the cartons being returned.

## ORDER CANCELLATION

Orders which have entered any stage of production cannot be cancelled. Requests for cancellation are not accepted until acknowledged by Safco. In the event cancellation is accepted by Safco Products, cancellation charges may apply and may be in the amount of the entire order.

## FREIGHT DAMAGE

All shipments must be carefully inspected upon receipt by the assigned freight forwarder to ensure all items are in satisfactory condition before signing the bill of lading. If there is visible damage or shortage, it must be noted on the bill of lading. If not notated, we will be unable to file a claim with the carrier due to their policies. Visible damage or shortage must be reported within 24 hours of receipt of goods by the freight forwarder.

## FINISHES

Photographic swatches have been provided to represent the many options you have when selecting a Safco product. Swatches should be used for reference only. If complementing an existing work environment is important, please request finish samples online at [www.safcoproducts.com](http://www.safcoproducts.com) or contact our Customer Care Team at [info@safcoproducts.com](mailto:info@safcoproducts.com).

## DESIGN

We reserved the right to make changes in design and material, as well as discontinuance of parts and units when such action is deemed to be an improvement in design, function and/or construction.

## Statement of Quality

# Statement of Quality

At Safco®, we understand that quality extends beyond simple function and we are committed to the highest level of satisfaction in the manufacture, sale and support of our products. From concept to delivery, we integrate high levels of quality as our standard and work hard to impress our customers every day. We strive for continuous improvements in all areas of product and service by regarding our quality programs as an integral part of the company's improvement process. Safco's quality program works to provide products that meet or exceed the quality standards our customers expect.

As an industry leader, Safco aims to set high environmental and safety standards by offering a large collection of third-party tested products that meet standards set forth by BIFMA, UL, the State of California, and others.

## ENVIRONMENTAL COMMITMENTS

Safco not only holds itself to strict environmental standards, but we also require suppliers to follow these standards as a total supply chain initiative. Suppliers play an important role in Safco's long-standing commitment to perform operations in a manner consistent with sound health, safety and environmental management practices. Because of this, suppliers are not only expected to comply with applicable health, safety and environmental laws and regulations, they are expected to seek continuous improvement within these realms.

Safco continues to become an environmentally conscious company with the intention to offer more products that our customers can feel good about, and responsible practices that encourage sustainability, helping us obtain a proud standing in our community and the planet.

## OPERATIONS

Safco advocates continuous improvement in the realms of efficient recycling and/or disposal of waste materials and improving treatment and control of waste emissions affecting air, water and soil. Safco also encourages the practice of waste reduction operations such as machine efficiency, raw material utilization, conservation of soil, air, water quality, biodiversity, wildlife and aquatic habitats, the practice of sustainable forest management policies where applicable, end-of-life treatment recommendations, raw material and recycled content regulation, and legal compliance with environmental legislation.



Office Suites	Page
Aberdeen® Laminate Series.....	12-18
Aberdeen® Laminate Series Idea Starters.....	18
CSII™ Modular Desking .....	33-47
CSII™ Overhead Storage & Pedestals .....	42-43
CSII™ Lateral Files .....	43
CSII™ Reception & Reception Typical.....	44
CSII™ Typical.....	45-47
Communication Station® Freestanding Worktables.....	48
Resi® Benches & Privacy Panels .....	49
Medina™ Laminate Series .....	19-24
Medina™ Laminate Series Idea Starters .....	24
Mirella™ Laminate Series .....	25-28
Mirella® Laminate Series Idea Starters.....	28
Sterling Laminate Series.....	29-32
Sterling Series Idea Starters .....	32
Power and Data Options/Grommet Options.....	50
Casegood Handle Options.....	50

Seating	Page
Active Seating .....	86-87
Alday™ 24/7 Task Seating.....	76
Apprentice II Extended-Height Seating .....	74
Arcozi Seating Series	
Arcozi Stack Seating .....	56
Arcozi Task Seating .....	57
Arcozi Bistro-Height & Classroom Seating .....	58
Ball Chairs	
Runtz™ Ball Chair & Swivel Ball Chair.....	87 & 274
Zenergy™ Ball Chair .....	87 & 274
Zenergy™ Swivel Ball Chair .....	87 & 274
Bandi™ Stack Chair .....	78
CoGo™ Steel Indoor/Outdoor Stack Chair & Benches.....	80
Commute Seating Series	
Commute Extended Height Task Chair.....	73
Commute Guest Chair.....	73
Commute Task Chair .....	73
Currant™ Stack Chair & Bistro Stools .....	78
Diesel Industrial Stools.....	83-276
Escalate Stacking Chairs .....	78
Lab Stool Seating .....	83-84
Lineage™ Big & Tall Seating .....	76
Lounge Series Furniture	
Resi® Collection .....	81
Santa Cruz® Lounge Series.....	82
Learn Soft Seating.....	82 & 275
Mirella™ Lounge .....	83
Resi® Lounge .....	83
Medina™ Seating Collection	
Medina™ Task Seating.....	71, 74
Medina™ Extended-Height Seating.....	72, 74
Medina™ Guest and Conference Seating .....	72, 79
Metro™ Extended-Height Task Seating.....	74
Moto™ Stack Chair.....	79
Next™ Stack Chair & Bistro Height Chair .....	79
Optimus™ Big & Tall Seating .....	77
Pique™ Stack Chair.....	80
Precision Extended-Height Seating .....	75

Seating	Page
Reve™ Seating Series	
Reve™ Guest Seating .....	59
Reve™ Sled Base Seating With Tablet Arm .....	60
Reve™ Manager Seating (Task Chairs) .....	61-62
Reve™ Bistro-Height Seating.....	62
Reve™ Counter-Height Seating .....	62
Safco® Stack Chair .....	80
Sassy® Seating Series	
Sassy® Series Stack Seating .....	63
Sassy® Series Bistro-Height Seating .....	64
Sassy® Task Seating .....	65
<b>Seating Features &amp; Fabric Grade Program.....</b>	<b>51-55</b>
Serenity™ Big & Tall Seating.....	77
Shell™ Desk Chair & Extended-Height Seating .....	74 & 75
SitStar™ Seating .....	84 & 276
Soft Seating (Learn) .....	82 & 275
Soft Tough™ Workbench Seating .....	85
Steel Stool Seating.....	84 & 276
Task Master® Office Stool & Workbench Seating .....	85
Thesis™ Seating Series	
Thesis™ Training Chairs .....	66
Thesis™ Extended-Height Task Chair .....	66 & 75
Twixt Active Seating	
Twixt™ Sitting & Extended-Height Chairs.....	86 & 275
Twixt™ Mid- & Extended-Height Saddle Stools .....	86
Chair Carts	
Two-Tier Chair Cart.....	79
Sled Base Stack Chair Cart.....	69, 80
Stacking Chair Cart.....	80
Uber™ Big & Tall Seating.....	77
Valoré® Seating Series	
Valoré® Training Series - High-Back .....	67
Valoré® Training Series - Mid-Back.....	68
Valoré® Height-Adjustable Task Chair.....	68
Vue™ Task Seating	
Vue™ Intensive-Use Task Seating .....	75
Vue™ Mesh Extended-Height Task Seating.....	75
Vy™ Seating Series	
Vy™ Stack Guest Seating.....	69
Vy™ Bistro-Height Seating .....	70
Vy™ Counter-Height Seating .....	70
WorkFit™ Polyurethane Seating.....	85



TIP: To jump to a specific section, click on the section title

<b>Tables &amp; Desks - Tables</b>	<b>Page</b>
Aberdeen® Conference Tables .....	17
Bistro Series Tables.....	101-102 & 281
Cha-Cha™ Square & Round Tables .....	100
CoGo™ Outdoor/Indoor Tables .....	80
Conference/Training Room Accessories .....	111
Corisca® Conference Tables.....	108
CSII™ Conference Tables.....	106
Event Series Folding/Stacking Multi-Purpose Tables.....	112
Flip-N-Go® Tables.....	92-93
Height-Adjustable Tables.....	103-107 & 280
Table Accessories .....	111
Jurni Series	
Training Tables .....	89
Cafe Tables.....	90
Conference Tables .....	90
Electrical Accessories .....	91
Medina™ Conference Tables .....	22
Mirella™ Conference Tables.....	27
ML-Series Height-Adjustable Tables .....	103-104
Napoli® Conference Tables .....	109
Oasis™ Teaming Tables .....	99
Rumba™ Nesting Tables .....	96

<b>Tables &amp; Desks - Desks</b>	<b>Page</b>
Torrento Conference Tables .....	109
Rumba™ Fixed Leg Tables.....	97
Spark™ Teaming Tables.....	99
Sterling Conference Tables .....	31
Sync™ Tables .....	94-95
Training Table Power Options.....	110
Universal Table Hooks .....	90 & 111
XR-Series.....	106-107
Adjustable Computer table .....	118
AlphaBetter® Desks & Stools .....	114-115 & 277-278
Brio™ Standing Desk .....	117
Defy™ Electric Adjustable-Height Desk.....	118
Eastwinds Furniture	
Portrait PC Desk Cart .....	118
Argo PC Workstation.....	118
FPD Computer Table.....	118
Laptop Caddy.....	118
Mobile Arch Computer Desk .....	118
Elevate™ Standing-Height Desks .....	117
Empire Mobile PC Station .....	118
Flip & Nest Desks .....	116 & 279
Mirella™ SOHO Desks.....	118
Muv™ Adjustable-Height Desks.....	116
Muv™ Fixed-Height Desks.....	116
Ready Collection - Desk, Large & Small Storage Cabinets.....	120
Resi® Office - Desk, Cabinet, Wardrobe & Hutch .....	119
Reversible Top Computer Desks .....	113
Roam™ Touchdown Workstation .....	117
Scoot™ Steel Desks.....	117
Ultimate Gaming Desk .....	120
Studio Desks .....	116
Table Desk .....	116
Verve™ Standing Desk.....	117
Vum™ Pneumatic Standing Desk.....	117
Wire Desk.....	279
Xpressions™ Computer Desks .....	117

<b>Meeting Essentials</b>	<b>Page</b>
Coat Hooks .....	127-128
Coat Racks & Wall Racks.....	126-127
Height-Adjustable Media/Design Centers .....	123
Hospitality Steel Refreshment Carts.....	125
Hospitality Wood Refreshment Carts.....	125
Impromptu® Collaboration Screens.....	121 & 279
Acrylic Screen.....	121
Whiteboard Screen .....	121 & 279
Mobile Whiteboard .....	121
Multimedia & AV Carts.....	122
Onyx™ Break Room Organizers .....	124
Onyx™ Marker Holders .....	121
Presentation Stands & Lecterns.....	123-124
Rumba™ Collaboration Screens.....	121 & 279
Write Way Dry Erase Message Signs .....	128

<b>Personal Organization</b>	<b>Page</b>
Desk Organization.....	132-133
Impromptu® Machine Stands .....	129
Machine Stands .....	129-131
Muv™ Printer/Machine Stands .....	129
Onyx™ Desk Organization .....	132
Onyx™ Magnetic Mesh Panel Organizers .....	140
Onyx™ Mesh Desktop Organizers.....	133-136
Onyx™ Mesh Desktop Tub and Box File Organizers .....	136
Onyx™ Mesh Hanging Storage Organizers .....	135
Onyx™ Mesh Wall Organizers.....	139
Onyx™ Power Mesh Desktop Organizers.....	134
Onyx™ Under Desk Machine Stands.....	131
PanelMate® – Dry Erase Board.....	139
Plastic Desk Accessories.....	132
Rolling Storage Cart.....	131
Scoot™ Printer Stands .....	130
Steel Book Storage.....	137
Steel Combination Desk Organizers .....	137
Steel Desk Organizers .....	137
Steel Machine Stands.....	130
Steel – Wall Pocket Organizers .....	139
Suggestion Boxes.....	138
Wave Printer Stands.....	130
Wood Desktop Organizers.....	132
Wood Machine Stands .....	129

<b>Ergonomics</b>	<b>Page</b>
Anti-Fatigue Mat.....	145
Backrests.....	146
CPU Holders.....	141
Electric Desktop Sit/Stand Desks .....	142
Ergonomic Accessories – Monitor Arms & Supports.....	143
Footrests .....	144
Height-Adjustable Keyboard Mechanism .....	141
Keyboard Supports.....	141
LED Task Lighting .....	143
Monitor Stands .....	141

Office Suites  
Seating  
Tables & Desks  
Meeting Essentials  
Personal Organization  
Ergonomics  
High Density Storage  
Storage & Filing  
Facilities  
Technology  
Art & Engineering  
K-12 Education  
SAFE Collection Addendum



TIP: To jump to a specific section, click on the section title

# Table of Contents

## High Density Storage

	Page
ARC™ Rotary Files .....	174
ARC™ Rotary File – Components.....	175-177
File Harbor Cabinets.....	168-172
File Harbor Cabinet Components .....	169-171
File Harbor Cabinets on Kwik-Track Typicals .....	172
Flip-n-File™ Cabinets .....	177
Flip-n-File™ Cabinets on Kwik-Track .....	177
Flip-n-File™ Insertables® Systems .....	178
Forms/Storage Cabinets .....	173
Heavy-Duty Shelving .....	166-167
High-Density Storage Space Planning Services Information .....	147
Lateral Files .....	179
Lateral Files on Kwik-Track.....	179
Mobile Aisle 1000™ .....	148
Mobile Lite Typicals.....	149-150
4-Post Shelving .....	151-156
4-Post Shelving Components .....	157-160
4-Post Shelving Security Components .....	161
4-Post Shelving with Roll Out Drawer Typicals.....	162
4-Post Shelving - Specifications .....	163
4-Post Shelving on Kwik-Track.....	164-165

## Storage & Filing

	Page
Clear2c™ Literature Displays .....	187
Hospitality Cabinets .....	184
Literature Display – Steel .....	189
E-Z Stor® Steel Literature Organizers .....	190
E-Z Stor® Steel Project Organizers.....	190
Value Sorter® Steel Literature Organizers.....	190
Wood/Corrugated Literature Organizers .....	191
E-Z Stor® Wood Literature Organizers .....	191
Wood Adjustable Literature Organizers .....	191
Luxe™ Literature Displays.....	184
Mobile Book Carts .....	193
Mobile File Carts .....	193-195
Wire Mobile File Carts.....	195
Wire Utility Cart.....	193
Scoot™ Steel Utility Cart .....	193
Mobile Carts .....	194
Mesh Mobile File Carts .....	194
Steel Tub Files .....	194
Scoot™ Mobile Carts .....	195
Wire Mobile File Cart .....	193
Onyx™ Mesh Display Racks.....	188-189
Onyx™ Mesh Mobile File Carts.....	195
Resi® Storage .....	180-181
Free Standing Lockers .....	180
A-Frame Workstation Lockers and Locker Options .....	181
Reveal™ Literature Displays .....	185-186
Reveal™ Tabletop Display .....	186
Steel Lockers .....	182
Steel Storage Cabinets .....	183
Steel Mobile File Carts .....	195
Wood Literature Displays .....	188
Steel Literature Displays.....	188
ValueMate® Steel Bookcases .....	192

## Facilities

	Page
Archival & Boltless Shelving.....	206
Black Speckle Waste Receptacles – Push & Open Top .....	197
Canmeleon™ Indoor/Outdoor Series Waste Receptacles.....	200
Canmeleon™ Pentagon Indoor/Outdoor Series Receptacles .....	200
Commercial Wire Shelving .....	207
Dome Top Receptacles .....	199
Evos™ Series Indoor/Outdoor Steel Receptacles.....	201
Hand Trucks.....	209
Economy Hand Trucks .....	209
Platform Trucks .....	210
Industrial Wire Shelving .....	207
Mailflow Systems® .....	212-223
Mailflow Systems® Specialized Sorters .....	224
Mailflow Systems® Shelves, Shelf Support & Accessories.....	225-227
Mailflow Systems® Tables, Storage Tables & Consoles .....	228-229
Mailflow Systems® Adjustable Shelf Kits & Accessory.....	230
Mailflow Systems® Build-Your-Own Shipping Workstations.....	231
Mailflow-to-Go™ Tables, Sorters & Cabinets .....	232-233
Mailroom Carts .....	210
Mailroom Sorters & Tables .....	211
Mixx™ Recycling Center .....	205
Nook™ Waste Receptacles.....	197
Open Top Receptacles .....	196
Public Square® Recycling Receptacles .....	204
Recycling Centers.....	203
Recycling Receptacles .....	203
At-Your-Disposal® Recycling Centers .....	203
Reflections by Saeco® Dome Top & Square Receptacles.....	196
Steel Shelving – Commercial & Industrial .....	208
Step-On Receptacles – Ellipse & Square.....	198-199
Plastic Step-On Receptacles .....	198
Stainless Step-On Receptacles .....	199
Trifecta® Waste Receptacles .....	205
Twist™ Indoor/Outdoor Waste Receptacles.....	199
Waste Receptacles .....	202
Smoker Receptacles .....	201
At-Your-Disposal® Waste Receptacles .....	201
Half Round Waste Receptacle .....	201
Onyx™ Mesh Round Waste Receptacles .....	202
Bubble Round Waste Receptacles .....	202
Round Waste Receptacles .....	202
Rectangular Waste Receptacles .....	202



TIP: To jump to a specific section, click on the section title

Technology Furniture	Page
Maytrix® LAN Racking System .....	234-239
Maytrix® LAN Racking System – Components & Accessories..	237-239
S/E Cabinet.....	239
TechWorks® Price List now available separately at: <a href="http://www.safcoproducts.com/products/literature">www.safcoproducts.com/products/literature</a>	

Art & Engineering	Page
Drafting Tables .....	241
Economy Art Storage.....	246
Facil Flat Files – 5 Drawer .....	245
Flat Files – 5 & 10 Drawer – Designer Colors .....	244
Futur-Matic® Drawing Tables .....	241
MasterFile 2 – High Density Vertical Storage .....	245
Media Storage .....	247
Ranger® 4-Post Drawing Tables.....	240
Roll Filing Systems .....	246-247
Steel Flat Files – 5 & 10 Drawer .....	243
Flat File Accessories .....	243
Vertical Hanging Files.....	242

K-12 Education	Page
AlphaBetter® Desks & Stools .....	257-258
Ball Chairs.....	254
Runtz™ Ball Chair.....	254
Runtz™ Swivel Ball Chair.....	254
Zenergy™ Ball Chair .....	254
Zenergy™ Swivel Ball Chair .....	254
Bistro Series Peanut Tables.....	261
Diesel Industrial Stools.....	256
Diesel Adjustable-Height.....	256
Diesel Low Base with Back .....	256
Fidget™ Active Stool .....	255
Learn Height-Adjustable Tables.....	260
Learn Nesting Trapezoid & Rectangle Desk .....	259
Rumba™ Collaboration Screen .....	259
Mobile Whiteboard .....	259
Safco® Soft Seating .....	255
SitStar™ Seating .....	256
Steel Stool Seating.....	256
Sync™ Conference/Training Tables .....	262
Twixt™ Active Seating Chair – Seating & Extended-Height .....	255
Whiffle Mobile Storage Units.....	248-253
Whiffle Mobile Storage Typical.....	251-253
Wire Desk.....	259
Wood Adjustable Literature Organizers.....	259

Safe Collection Addendum	Page
Wellness Screens & Panels, Hand Sanitizer Stand .....	262

Sales Resources	Page
Corporate Laminate & Paint Program .....	10
Custom Request Form .....	11
Seating Features & Fabric Grade Program.....	51-55
CSL (Customer Specified Laminate).....	88
Product Index by Model Number .....	263



## Corporate Laminate and Paint program

For many Safco® product lines, standard Corporate Color Program is available. Select product lines have limited finish options and are noted individually within each product section. For examples of standard finishes, please refer to our Resources section on [www.safcoproducts.com](http://www.safcoproducts.com).

### Powdercoat Paint Colors

Our standard paint offering is available on 4-Post, Arc Rotary, CSII™, File Harbor, E Series Tables, Forms/Storage, Mailflow, Maytrix®, and High-Density Mobile Storage.

Refer to ordering guidelines on the product pages as some exceptions may apply.

Black	Desert Sage	Medium Blue	Mist	Navy
Tech Silver	Textured Black	Textured Graphite	Textured Gray	White

**Note:** Mailflow-to-Go® is available in Pebble Gray. CSII™ lateral files are available in Black, Medium Tone, Desert Sage and Mist paint options only.

### High Pressure Laminates (HPL) and Edge Band Colors

All HPLs are available on the following product lines: Flip N Go, Sync, Bistro, ML, E-Series and XR Height Adjustable Tables, Maytrix®, CSII™, Arc Rotary, and Mailflow

Refer to ordering guidelines on the product pages as some exceptions may apply.

#### High Pressure Laminates (HPL)

Asian Night	Columbian Walnut
Asian Sand	Designer White
Biltmore Cherry	Fashion Gray
Black	Fusion Maple

#### High Pressure Laminate Edge Band Colors

Black	Designer White	Ice Gray
-------	----------------	----------

**Note:** \*Gray ESD is only available on TechWorks® and Maytrix® product lines.  
\*Storm Gray Matrix and Stainless Steel only available on TechWorks®.

### Thermally-Fused Laminates (TFL) and Edge Colors

All TFLs are available on the following product lines: Flip N Go, Sync, Bistro, E Series Tables, and Arc Rotary.

Refer to ordering guidelines on the product pages as some exceptions may apply.

#### Thermally-Fused Laminates (TFL)

Anthracite	Birch	Fog Gray	Folkstone
Mocha	Regal Mahogany	Speckled Gray Matrix	

#### Thermally-Fused Laminate Edge Band Colors

Black	Ice Gray	Taupe
-------	----------	-------

**Note:** Mailflow-to-Go® is only available in Birch with Ice Gray edging. Eastwinds product line is available in Anthracite and Medium Cherry only.

# Custom Product Request Form

All requests for customization of product, sizes and finishes must have prior approval.  
Please email [specials@safcoproducts.com](mailto:specials@safcoproducts.com)

Dealer Name \_\_\_\_\_

Dealer Address \_\_\_\_\_

City, State, Zip \_\_\_\_\_

Safco Sales Representative \_\_\_\_\_

Project Name \_\_\_\_\_

Expected Time Line \_\_\_\_\_

Install Date \_\_\_\_\_

Is this a standards program Yes or NO If Yes, Length of Standards \_\_\_\_\_

Laminate/Paint Manufacturer \_\_\_\_\_

Laminate or Paint Manufacturer Phone Number ( ) \_\_\_\_\_

Laminate or Paint Name \_\_\_\_\_

Laminate or Paint Number \_\_\_\_\_

Safco Model/Series Number \_\_\_\_\_

Quantity \_\_\_\_\_

Is there a desired top and bottom to the laminate application? Yes \_\_\_ No \_\_\_

If yes, clearly specify how laminate is to be applied

### Please Note:

- Due to standard laminate sheet sizes, most laminates will need to be applied in a horizontal orientation.
- Limited Lifetime Warranty does not extend to Customer Custom Options
- All Custom Options must be approved by Safco's Specials Department before Purchase Order submission

We require 3 sample chips mailed for all color matches along with form to:

Safco Products Company  
9300 West Research Center Road  
New Hope, MN 55428

**Attn: Specials**





# Casegoods - Laminate and Veneers

Safco® Products marketing materials are designed to be used as sales tools for our Dealer network.

LAMINATES	Cherry	Gray Steel	Mahogany	Maple	Mocha	Sand Dune	Southern Tobacco	Stone Gray	Textured Brown Sugar	Textured Driftwood	Textured Mocha	Textured Sea Salt	White Ash
Aberdeen		LGS			LDC								
Medina		LGS			LDC							TSS	
Mirella						SDD	STO	SGY					WAH
Sterling										TDW	TDC		
veneers	Bourbon Cherry	Charcoal	Espresso	Mahogany	Sierra Cherry								
Napoli		CGR		MAH	CRY								
Sorrento	SCR		ESP										
Corsica - Conference Tables				MAH	CRY								

## Aberdeen® Laminates

Aberdeen provides exceptional abrasion and stain resistance along with technology and cable friendly components.

**Laminate Options:** Mocha-LDC and Gray Steel-LGS.

**CARB Compliant:** Aberdeen's core materials comply with Phase 2 of CARB's formaldehyde emission limits of composite wood materials.

• Horizontal surfaces feature fluted 3 MM PVC edge

• Recommended under-cabinet LED Task Light is model EZDP. Other LED Task/Desk lighting is available in the Ergonomics section page 149

### BOW FRONT DESK

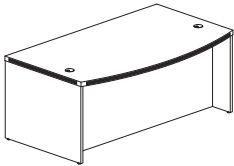

- 1½" thick work surface
- Full-height, vertical grain, modesty panel included

- Modesty panel is recessed 14½" at center
- Two grommets in surface, standard

Model No.	Description	Dimensions	Weight	List Price
ABD7242	72" Bowfront Desk	72"W x 42"D x 29½"H	233	1,505.00

### CONFERENCE FRONT DESK

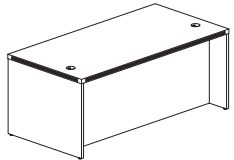

- 1½" thick work surface
- Modesty panel is recessed 8½" at center

- Full-height, vertical grain, modesty panel included
- Two grommets in surface, standard

Model No.	Description	Dimensions	Weight	List Price
ARD6630	66" Rectangular Conference Desk	66"W x 30"D x 29½"H	159	877.00
ARD7236	72" Rectangular Conference Desk	72"W x 36"D x 29½"H	215	1,303.00

### TABLE DESK

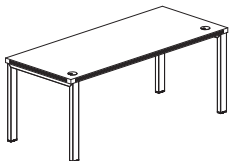

- Silver Base
- Not available in Maple

- Standard with two grommet holes for cable management

Model No.	Description	Dimensions	List Price
ABTDS72	Table Desk with Straight Top	72"W x 30"D x 29½"H	1,356.00

### CREDENZA

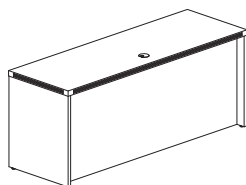

- 1½" thick work surface
- One grommet in surface, standard
- Full-height, vertical grain, modesty panel included

- Mouse hole in modesty panel for cable pass through
- Modesty panel is recessed 3" for outlet clearance

Model No.	Description	Dimensions	Weight	List Price
ACD7224	72" Credenza	72"W x 24"D x 29½"H	160	1,052.00

- Adjusts easily from 29½ - 49¼"
- Surfaces are abrasion and stain resistant for durability
- Includes built-in Brushed Nickel grommets to connect to power with ease
- All pieces feature durable 1½" thick work surfaces, with a distinctive fluted edge and vertical grain modesty panels
- Pieces coordinate with Aberdeen® Desking, Conference and Reception Furniture
- Drive System 110V, 60Hz AC input 120V DC motor draws a maximum of 3 amps for quick and easy movement

- Moves at a speed of ¾" per second for quick adjustment
- Control Switch has Up/Down Buttons with four position memory; sold as standard for ease of reconfiguration
- Dual motor system base
- Hidden Modesty Panel will rise as the Desk rises
- **Laminate Options:** Gray Steel-LGS, Mocha-LDC

**Aberdeen Height-Adjustable Bow Front Desk** 

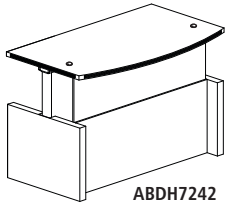

- Dual motor base
- Hidden Modesty Panel will rise as the Desk rises

Model No.	Description	Dimensions	Weight	List Price
ABDH7242	72" Bow Front Desk with Base	72"W x 42"D x 29½ - 49¼"H	317	3,444.00

**Aberdeen Height-Adjustable Conference Front Desk** 

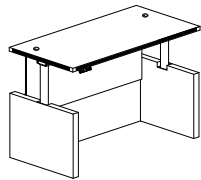

- Dual motor base
- Hidden Modesty Panel will rise as the Desk rises

Model No.	Description	Dimensions	Weight	List Price
ARDH7236	72" Conference Front Desk with Base	72"W x 36"D x 29½ - 49¼"H	310	3,276.00

**Aberdeen Height-Adjustable Bow Front Desk with Return** 

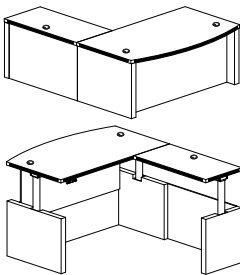

- Dual motor system base
- Hidden Modesty Panel will rise as the Desk rises
- No hidden modesty panel on the return
- Non-Handed return is 24" deep, mount on left or right side

Model No.	Description	Dimensions	Weight	List Price
AT56	72 x 42" Bow Front Desk with Return with Base	72"W x 90" D x 29½ - 49¼"H	434	4,919.00

**Aberdeen Height-Adjustable Straight Front Desk with Return** 

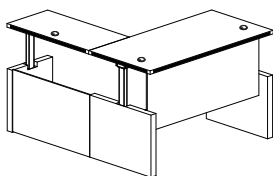

- Dual motor base
- Hidden Modesty Panel will rise as the Desk rises
- No hidden modesty panel on the return
- Non-Handed return is 24" deep, mount on left or right side

Model No.	Description	Dimensions	Weight	List Price
AT58	72 x 36 Straight Front Desk with Return and Base	72"W x 84"D x 29½ - 49¼"H	427	4,754.00

**BRIDGE**  

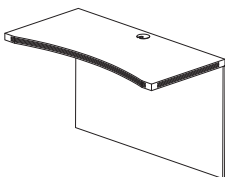

- Universal mounting to right or left side of Desk
- Not free-standing. Requires connection to Credenza and Desk
- 1½" thick work surface
- Full-height, vertical grain modesty panel included
- Modesty panel is flush against Bridge
- One grommet in surface, standard
- Mouse hole in modesty panel for cable pass through

Model No.	Description	Dimensions	Weight	List Price
ACB4224	42" Curved Bridge	42"W x 24"D x 29½"H	63	597.00

**RETURN**  

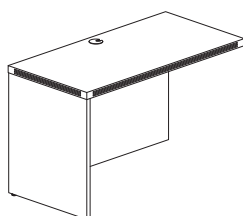

- Returns are non-handed
- Not free-standing. Requires connection to Credenza, Desk or Extended corner
- Mouse hole in modesty panel for cable pass through
- Modesty panel is flush against Return
- One grommet in surface, standard
- 1½" thick work surface
- Full-height, vertical grain modesty panel included

Model No.	Description	Dimensions	Weight	List Price
AR4224	42" Return	42"W x 24"D x 29½"H	96	677.00

Office Suites  
Seating  
Tables & Desks  
Meeting Essentials  
Personal Organization  
Ergonomics  
High Density Storage  
Storage & Filing  
Facilities  
Technology Furniture  
Art & Engineering  
K-12 Education  
SAFE Collection Addendum

**EXTENDED CORNER**

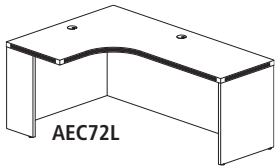

- 1½" thick work surface
- Full-height, vertical grain, modesty panel included
- Modesty panel is recessed 3" for outlet clearance on Desk side and flush on return side

- Two grommets in surface, standard
- Mouse hole in modesty panel (Desk side) for cable pass through

Model No.	Description	Dimensions	Weight	List Price
AEC72L	72" Left Extended Corner Table	72"W x 48"D x 24"D Return x 29½"H	218	1,679.00
AEC72R	72" Right Extended Corner Table	72"W x 48"D x 24"D Return x 29½"H	218	1,679.00

**FREESTANDING PENINSULA DESK**

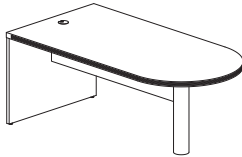

- 1½" thick work surface
- Modesty panel is 12"H
- One grommet in surface, standard

- Mouse hole in modesty panel for cable pass through
- Does not accommodate a center drawer

Model No.	Description	Dimensions	Weight	List Price
APT7236	72" Freestanding Peninsula	72"W x 36"D x 29½"H	172	1,451.00

**PEDESTAL FILE FOR DESK**

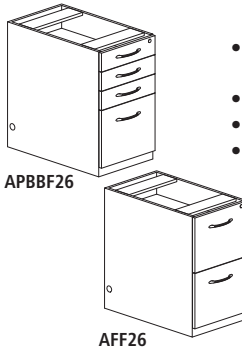

- Pedestals have integrated cable management access at top and bottom of Pedestals
- Pedestal tops are unfinished. Must be attached to underside
- Pedestals cannot be used with height-adjustable desks
- Feature dual-purpose pencil drawers for storing supplies or laptops

- All locks are keyed alike. Lock cores are removable for keying suites individually
- Curved metal pulls with Brushed Nickel finish
- File drawers accommodate letter- or legal-size hanging file folders
- Pedestals ship fully assembled

Model No.	Description	Dimensions	Weight	List Price
APBBF26	Desk Pencil/Box/Box/File Pedestal	15¼"W x 26½"D x 27½"H	90	1,126.00
AFF26	Desk File/File Pedestal	15¼"W x 26½"D x 27½"H	86	1,076.00

**PEDESTAL FILE FOR CREDENZA/RETURN/EXTENDED CORNER**

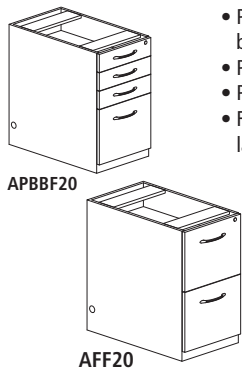

- Pedestals have integrated cable management access at top and bottom of ped
- Ped tops are unfinished. Must be attached to underside of surface
- Pedestals cannot be used with height-adjustable desks
- Feature dual-purpose pencil drawers for storing supplies or laptops

- All locks are keyed alike. Lock cores are removable for keying suites individually
- Curved metal pulls with Brushed Nickel finish
- File drawers accommodate letter or legal size hanging file folders
- Pedestals ship fully assembled

Model No.	Description	Dimensions	Weight	List Price
APBBF20	Credenza Pencil/Box/Box/File Pedestal	15¼"W x 20"D x 27½"H	75	1,000.00
AFF20	Credenza File/File Pedestal	15¼"W x 20"D x 27½"H	74	951.00

**LATERAL FILE FOR CREDENZA/RETURN/EXTENDED CORNER**

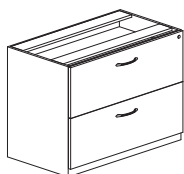

- Credenza Laterals slide easily under any surface
- Credenza Lateral top is unfinished
- Drawers can support up to 2 lbs. per inch

- Curved metal pulls with Brushed Nickel finish
- All locks are keyed alike. Lock cores are removable for keying suites individually

Model No.	Description	Dimensions	Weight	List Price
ACLF36	36" Credenza Lateral File	36"W x 20"D x 27½"H	126	1,377.00

**FREESTANDING LATERAL FILE**

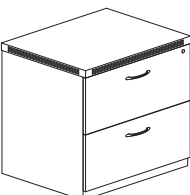

- 1½" surface allows it to be used alone or next to any Credenza or Return
- Drawers can support up to 2 lbs. per inch
- Drawers can be configured for front-to-back or side-to-side filing

- Curved metal pulls with Brushed Nickel finish
- All locks are keyed alike. Lock cores are removable for keying suites individually

Model No.	Description	Dimensions	Weight	List Price
AFLF36	36" Freestanding Lateral File	36"W x 24"D x 29½"H	240	1,753.00



REPLACEMENT LOCK CORES



- Allows pedestals and laterals to be keyed uniquely for up to fifteen different workstations
- Master key available
- Must purchase a core removal tool to change locks cores

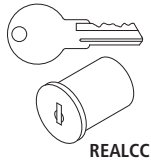

Model No.	Description	Weight	List Price
REALCC0311 through REALCC0325	Replacement Core with Keys, Silver	1	42.00
REALCRK	Core Removal Tool	1	42.00
REALCMK	Master Key	1	42.00

SKINNY PEDESTAL

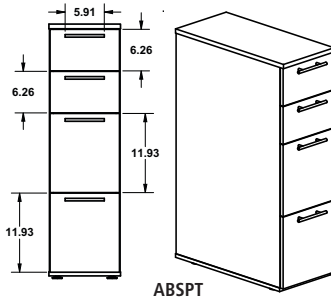

Model No.	Description	Dimensions	Weight	List Price
ABSP	Skinny Pedestal	10¼" W x 23" D x 24½" H	53	588.00
ABSPT	Skinny Pedestal (Tall)	10¼" W x 23" D x 38½" H	86	763.00

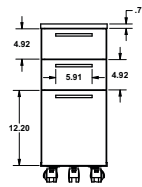

- Front 3 casters are 2" high locking casters
- Available in Aberdeen® laminate colors

CENTER DRAWER

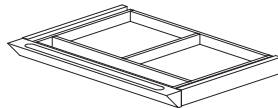

- Solid wood frame construction
- Drawer operates smoothly on full-extension ball bearing suspension

- Available in Graphite with Black drawer front only

Model No.	Dimensions	Weight	List Price
ACD	25" W x 18" D x 2" H Assembled	13	299.00
ACD530	25" W x 12½" D x 2" H Use with 30" D Height-Adjustable Desks	13	296.00

WALL MOUNT HUTCH

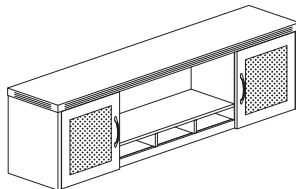

- Two textured glass doors, central opening and pigeon hole slots
- Central opening sized for binder storage

- Wall mounting brackets included
- Curved metal pulls with Brushed Nickel finish
- 150 lb. weight capacity

Model No.	Description	Dimensions	Weight	List Price
AWG72	72" Wall Mount Hutch	72" W x 15" D x 19½" H	121	1,264.00

HUTCH WITH WOOD DOORS

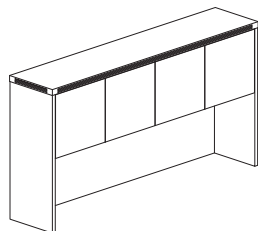

- Features four cabinet styled doors with self-closing hinges
- Back panel features two cable grommets

- 21½" clearance between work surface and bottom of shelf
- Accepts optional Fabric Tack Panel and Task Light

Model No.	Description	Dimensions	Weight	List Price
AHW72	72" Hutch with Wood Doors	72" W x 15" D x 39½" H	142	1,283.00

HUTCH WITH GLASS DOORS

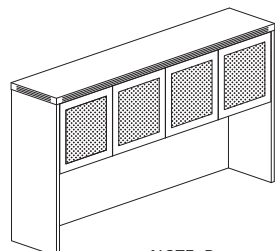

- Glass is tempered for safety and durability
- Features four cabinet styled doors with self-closing hinges
- Back panel features two cable grommets

- 21½" clearance between work surface and bottom of shelf
- Accepts optional Fabric Tack Panel and Task Light

Model No.	Description	Dimensions	Weight	List Price
AHG72	72" Hutch with Glass Doors	72" W x 15" D x 39½" H	142	1,753.00

NOTE: Recommended under-cabinet LED Task Light is model EZDP. Other LED Task/Desk lighting is available in the Ergonomics section page 149.



These products are subject to California Proposition 65. Please visit the product detail page on our website for specific information.

**HUTCH TACK PANEL**

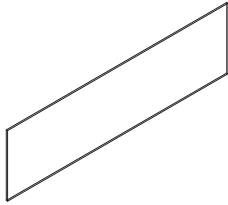

- Attaches to Hutch back panel using adhesive tape
- Allows for access to the Hutch's grommet for cable management
- Available in Black fabric only

Model No.	Description	Dimensions	Weight	List Price
AFTP72	72" Fabric Tack Panel	69¾"W x ½"D x 19¼"H	6	349.00

**PAPER MANAGEMENT ORGANIZERS**

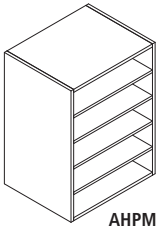

AHPM

- Can accommodate legal-sized documents
- Sized to fit under Hutch

Model No.	Description	Dimensions	Weight	List Price
AHPM	Horizontal Paper Management	15"W x 11¼"D x 20¼"H	32	349.00

**BOOKCASES**

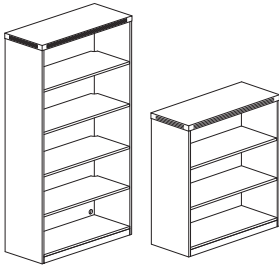

AB5536

AB3536

- Shelves are adjustable on 1¼" increments with 5" of total adjustment
- Shelves contain corner mouse holes for vertical cable management
- Back panel provides grommet for wall access
- Quarter Round Bookcase shelf support 25. lbs per shelf
- Standard Bookcases support 75 lbs. per shelf, evenly distributed

Model No.	Description	Dimensions	Weight	List Price
AB5536	5 Shelf Bookcase (1 fixed shelf)	36"W x 15"D x 68¾"H	175	1,177.00
AB3536	3 Shelf Bookcase	36"W x 15"D x 39⅞"H	117	977.00

**PERSONAL STORAGE TOWER**



- Includes 7¾" wardrobe section with a hanging rod and four adjustable shelves
- Storage section includes two adjustable shelves on 1¼" increments with a total of 5" of adjustment
- File section includes two file drawers
- Curved metal pulls with Brushed Nickel finish. Additional pull options available
- Ships in two cartons

Model No.	Description	Dimensions	Weight	List Price
APST	Personal Storage Tower	24"W x 24"D x 68¾"H	248	2,006.00

**GLASS DISPLAY CABINET**

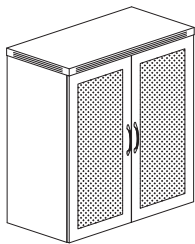

- Glass is tempered for safety and durability
- Two (2) adjustable shelves on 1¼" increments with a total of 5" of adjustment
- Curved metal pulls with Brushed Nickel finish. Additional pull options available
- Grommet in back panel for wall access
- Mouse hole in shelf to permit vertical routing of cables

Model No.	Description	Dimensions	Weight	List Price
AGDC	Glass Display Cabinet	36"W x 18"D x 39¾"H	135	1,624.00

**STORAGE CABINET**

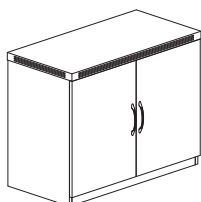

- Self-closing hinged doors
- One shelf adjustable on 1¼" increments with a total of 5" of adjustment
- Shelf contains corner mouse hole for vertical cable management
- Mouse hole in back panel for wall access
- Curved metal pulls with Brushed Nickel finish. Additional pull options available

Model No.	Description	Dimensions	Weight	List Price
ASC	Storage Cabinet	36"W x 18"D x 29½"H	132	1,251.00

Office Suites  
Seating  
Tables & Desks  
Meeting Essentials  
Personal Organization  
Ergonomics  
High Density Storage  
Storage & Filing  
Facilities  
Technology Furniture  
Art & Engineering  
K-12 Education  
SAFE Collection Addendum

**LOW WALL CABINET**

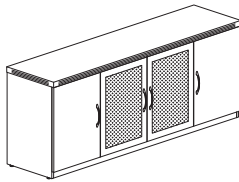

- Self-closing hinged doors
- One shelf per compartment adjustable on 1/4" increments with a total of 5" of adjustment. (3 shelves total)
- Shelves contain corner mouse hole for vertical cable management
- Mouse hole in back panel for wall access
- Curved metal pulls with Brushed Nickel finish standard. Additional pull options available

Model No.	Description	Dimensions	Weight	List Price
ALC	Low Wall Cabinet	72"W x 18"D x 29 1/2"H	173	2,257.00

**RECEPTION ACCESSORIES**

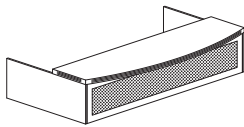

- For main reception Desk. To be used on ARD7236 page 11
- Textured glass front panel
- 1 1/8" thick bow front transaction counter. 6" overhang

Model No.	Description	Dimensions	Weight	List Price
ARDTC	72" Reception Transaction Counter	72"W x 42"D x 15 1/2"H	113	1,177.00

**CONFERENCE TABLES**



- 1 1/2" thick work surface
- Surfaces feature hollow core construction
- Boat-shaped conference tables standard with two grommets (6' has one centered grommet, 18' has 3 grommets)
- Boat-shaped conference tables accept power module for power and data access
- Round conference tables have one round grommet
- Conference table legs have cable chimney for concealed cable management from surface to floor
- Tops larger than 96" have multi-piece top surfaces connected via steel cam post and steel connecting plates
- Large conference tables ship in multiple cartons
- Structural modesty panel conceals horizontal cable management
- ACTB18 not available in Gray Steel

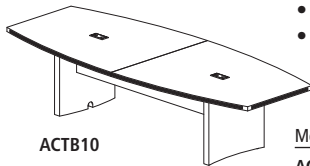

ACTB10



ACTR42

Model No.	Description	Dimensions	Weight	List Price
ACTB18	18' Conference Table, Boat Top	216"W x 48"D x 29 1/2"H	650	5,973.00
ACTB12	12' Conference Table, Boat Top	144"W x 48"D x 29 1/2"H	500	3,469.00
ACTB10	10' Conference Table, Boat Top	120"W x 48"D x 29 1/2"H	416	2,903.00
ACTB8	8' Conference Table, Boat Top	96"W x 48"D x 29 1/2"H	344	2,399.00
ACTB6	6' Conference Table, Boat Top	72"W x 36"D x 29 1/2"H	233	1,654.00
ACTR42	42" Round Conference Table	42"Dia x 29 1/2"H	105	1,168.00

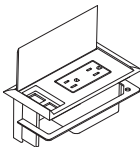

Model No.	Description	List Price
SPM	6 1/4"W x 4"D x 1 1/2"H Optional Power Module, UL Listed [includes RJ11-Cat 3 coupler (phone) and RJ45 coupler (data)] – 6' power cord	448.00

**LECTERN**

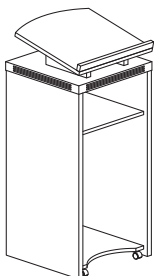

- One fixed shelf
- Four casters concealed in lectern base, non-locking
- Angled stand has stop to prevent papers from sliding
- Top surface has a grommet for cable pass-through

Model No.	Description	Dimensions	Weight	List Price
ALCT	Lectern	18"W x 18"D x 44"H	78	966.00

# Aberdeen® Idea Starters

Safco® Products marketing materials are designed to be used as sales tools for our Dealer network.

• Order components separately.

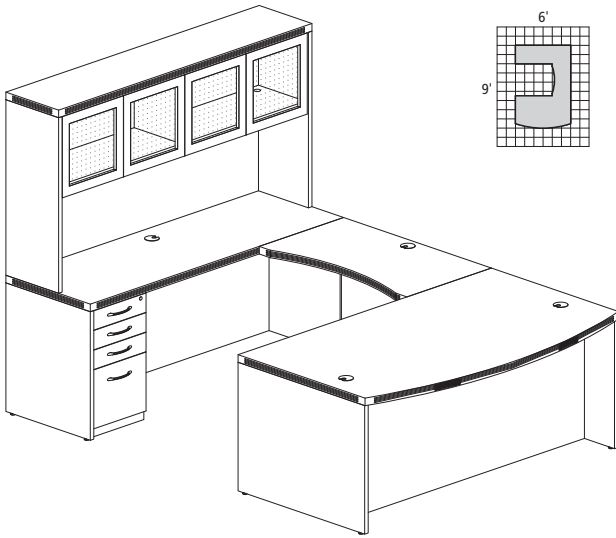

### ABERDEEN IDEA STARTER #1

Consists of:

QTY.	MODEL NO.	DESCRIPTION	LIST PRICE EACH
1	ABD7242	Bowfront Desk, 72 x 42"	1,505.00
1	ACD7224	Credenza, 72 x 24"	1,052.00
1	ACB4224	Contour Bridge, 42 x 24"	597.00
1	APBBF26	Desk Pencil/Box/Box/File Pedestal	1,126.00
1	APBBF20	Credenza Pencil/Box/Box/File Pedestal	1,000.00
1	AHG72	Hutch with Glass Doors, 72"W	1,753.00
			7,033.00

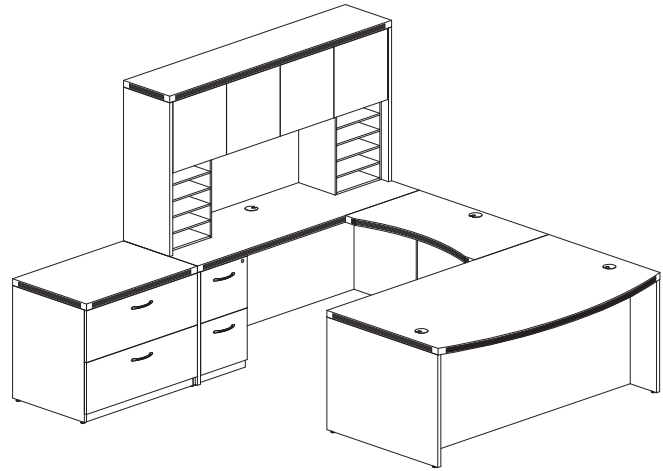

### ABERDEEN IDEA STARTER #2

Consists of:

QTY.	MODEL NO.	DESCRIPTION	LIST PRICE EACH
1	ABD7242	Bowfront Desk, 72 x 42"	1,505.00
1	ACB4224	Contour Bridge, 42 x 24"	597.00
1	ACD7224	Credenza, 72 x 24"	1,052.00
1	APBBF26	Desk Pencil/Box/Box/File Pedestal	1,126.00
1	AFF20	Credenza File/File Pedestal	951.00
1	AFLF36	Freestanding Lateral File, 36 x 24"	1,753.00
1	AHW72	Hutch with Wood Doors, 72"W	1,283.00
2	AHPM	Horizontal Paper Management	349.00
			8,965.00

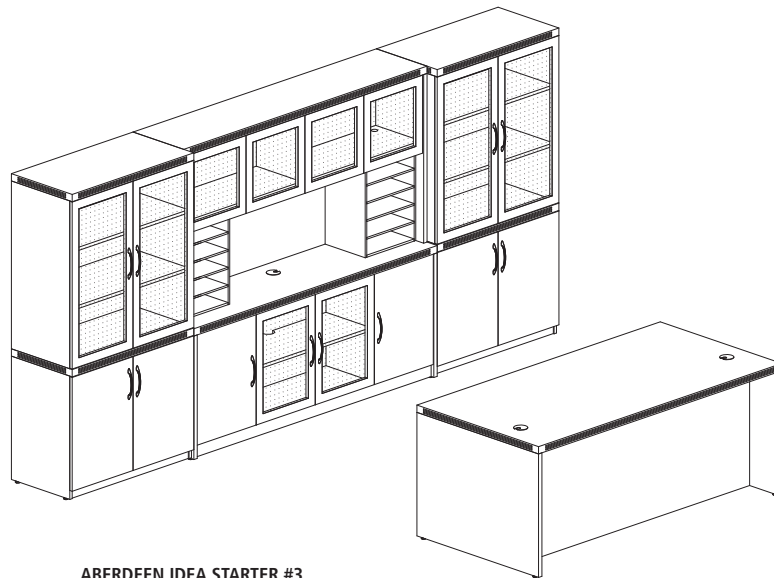

### ABERDEEN IDEA STARTER #3

Consists of:

QTY.	MODEL NO.	DESCRIPTION	LIST PRICE EACH
1	ARD7236	Rectangular Conference Desk, 72 x 36"	1,303.00
1	APBBF26	Desk Pencil/Box/Box/File Pedestal	1,126.00
1	AFF26	Desk File/File Pedestal	1,076.00
1	ALC	Low Wall Cabinet	2,257.00
2	ASC	Storage Cabinet	1,251.00
2	AGDC	Glass Display Cabinet	1,624.00
1	AHG72	Hutch with Glass Doors, 72"W	1,753.00
2	AHPM	Horizontal Paper Management	349.00

13,963.00





## MEDINA DESK SYSTEM

**Laminate Options:** Gray Steel-LGS, Mocha-LDC and Textured Sea Salt-TSS.

**CARB Compliant:** Core materials comply with Phase 2 of CARB's formaldehyde emission limits of composite wood materials.

- All Desk, Return and Extension work surfaces are 1" thick with a distinctive beveled edge
- All locks are keyed-alike and feature removable cores for installing "keyed-different" locks after-market
- PVC edge
- All floor supported models include steel threaded leveling glides.
- Models in all finishes are available on both the Quick Ship and Freight delivery programs with no quantity limitations
- Recommended under-cabinet LED Task Light is model EZDP. Other LED Task/Desk lighting is available in the Ergonomics section page 149

### CURVED DESK

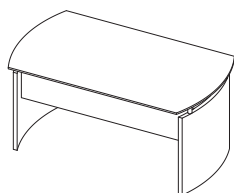

- Floating Top with Silver supports
- Silver modesty panel
- Curved end panels reflect curved ends of work surface

Model No.	Dimensions	Weight	List Price
MND72	72"W x 36"D x 29½"H Curved Ends	132	1,175.00

### CURVED DESK RETURN WITH PENCIL/BOX/FILE PEDESTAL

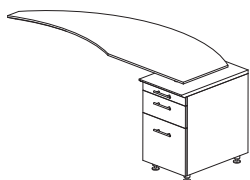

- Works only with MND63 and MND72
- Creates L-shaped work surface when attached to Desk
- Gang-lock features removable core
- Available for right or left side of Desk
- Supported by Return Pencil-Box-File Pedestal
- Stands off on Silver legs

Model No.	Description	Dimensions	Weight	List Price
MNRTPR	63" Right Return	63"W x 24"D x 29½"H	119	1,257.00
MNRTPL	63" Left Return	63"W x 24"D x 29½"H	119	1,257.00

### CURVED DESK EXTENSION

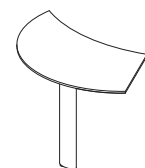

- Works only with MND63 and MND72
- Available for right or left side of Desk
- Supported by Silver stand offs

Model No.	Description	Dimensions	Weight	List Price
MNEXTR	Right Extension	47"W x 28"D x 29½"H	49	712.00
MNEXTL	Left Extension	47"W x 28"D x 29½"H	49	712.00

### BRIDGE



- Works only with MND63 and MND72
- Not free standing. Requires connection to Credenza and Desk
- Features modesty panel

Model No.	Description	Dimensions	Weight	List Price
MNBDGR	Right Hand Bridge	48"W x 24"D x 29½"H	62	590.00
MNBDGL	Left Hand Bridge	48"W x 24"D x 29½"H	62	590.00

### CREDENZA

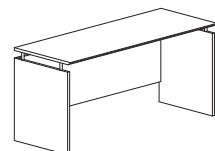

Model No.	Dimensions	Weight	List Price
MNCN272	72"W x 20"D x 29½"H	110	765.00

Note: Credenza can be used with both the Curved Desks and Straight Desks.

**HUTCH** 

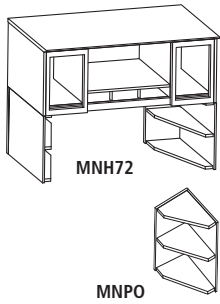

- Frosted glass doors with Silver frames
- Two open compartment slots
- Fully assembled
- Wall mounted or sits on corner supports
- Two corner supports are needed to support a hutch

Model No.	Description	Dimensions	Weight	List Price
MNH63	63" Hutch	63"W x 15"D x 18¼"H	128	1,211.00
MNH72	72" Hutch	72"W x 15"D x 18¼"H	132	1,409.00
MNPO*	Corner Support	15"W x 15"D x 20"H	33	191.00

\* Two corner supports are needed to support a hutch.  
Note: Hutchs can be used with both the Curved Desks and Straight Desks.

**STRAIGHT DESK** 

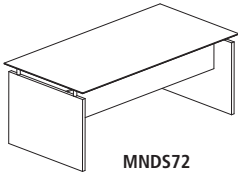

- Floating Top with Silver supports
- Silver modesty panels

Model No.	Dimensions	Weight	List Price
MNDS63	63"W x 36"D x 29½"H, Rectangle	128	1,115.00
MNDS72	72"W x 36"D x 29½"H, Rectangle	132	1,175.00

**TABLE DESK** 

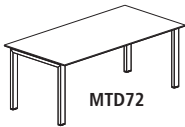

- No grommets
- Silver Base

Model No.	Description	Dimensions	List Price
MTD72	Table Desk with Straight Top	72"W x 36"D x 29½"H	1,248.00

**UNIVERSAL RETURN** 

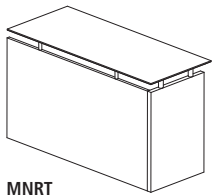

- Works only with MNDS63 and MNDS72
- Creates L-shaped work surface when attached to Desk
- Full modesty panel

Model No.	Description	Dimensions	Weight	List Price
MNRT	Non-Handed Return	48½"W x 20"D x 29½"H	119	602.00

**NON-HANDED STRAIGHT BRIDGE** 

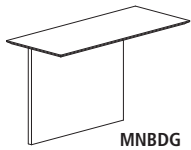

- Works only with MNDS63 and MNDS72
- Not free standing. Requires connection to Credenza and Desk
- Features modesty panel

Model No.	Description	Dimensions	Weight	List Price
MNBDG	Non-Handed Straight Bridge	48½"W x 20"D x 29½"H	62	590.00

**Medina™ Height-Adjustable Bridge** 

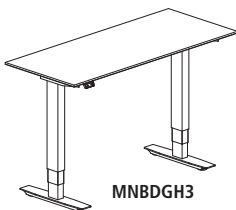

- Return includes (1) 3-Stage ML-Series Height-Adjustable Base with (1) pair of 18" feet with brackets
- Modesty Panel cannot be used when using the Height-Adjustable Base
- **Laminate Options:** Gray Steel-LGS, Mocha-LDC, Textured Sea Salt-TSS
- Freestanding unit; not attached to Credenza and Desk
- Leave 1" clearance on each side between Desk or Credenza and Bridge when assembled to allow table to move free of obstruction

Model No.	Description	Dimensions	Weight	List Price
MNBDGH3	48" Non-Handed Straight Bridge with 3-Stage Height-Adj. Base	48"W x 20"D x 24½" to 50"H	127	2,158.00

**MOBILE PEDESTALS**

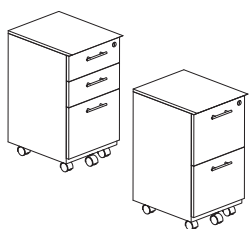

- Accommodate letter sized hanging file folders only
- Drawers operate smoothly using full-extension ball-bearing suspensions
- Fits under Credenzas
- 2" dual-hooded casters

Model No.	Description	Dimensions	Weight	List Price
MNBBF	Box/Box/File	15½"W x 18"D x 26¾"H	70	772.00
MNFF	File/File	15½"W x 18"D x 26¾"H	68	712.00

**CENTER DESK DRAWER**

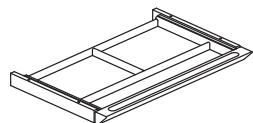

- Solid wood frame construction
- Drawer operates smoothly using full-extension ball-bearing suspension
- Available in Graphite with Black drawer front only

Model No.	Dimensions	Weight	List Price
ACD	25"W x 18"D x 2"H	13	299.00
ACDS30	25"W x 12½"D x 2"H Use with 30"D Height-Adjustable Desks	13	296.00

**LATERAL FILE**

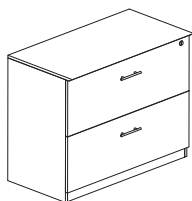

- Accommodates letter- and legal-sized hanging file folders
- Includes counter-weight for stability when in use
- Gang-lock features removable core enabling keyed-alike suites
- Drawers operate smoothly using full-extension ball-bearing suspensions

Model No.	Description	Dimensions	Weight	List Price
MVLF	File/File Lateral	36"W x 20"D x 29½"H Assembled	180	1,468.00

**LOW WALL CABINET WITH DOORS**

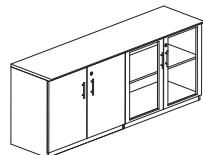

- Sets of doors lock separately. Keyed alike
- Includes one adjustable shelf on each side

Model No.	Description	Dimensions	Weight	List Price
MVLC	Wood/Glass Door Combination	72"W x 20"D x 29½"H	190	1,707.00

**STORAGE CABINET**

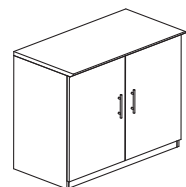

- Self-closing hinged doors
- One (1) shelf adjustable on 1¼" increments
- Mouse hole in back panel for wall access
- Shelf contains corner mouse hole for vertical cable management

Model No.	Description	Dimensions	Weight	List Price
MSC	Storage Cabinet	36"W x 20"D x 29½"H	96	1,217.00

**BOOKCASES**

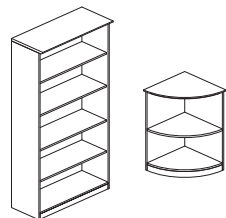

- Open shelves for convenient storage
- Choice of two or five shelf units
- Adjustable shelves
- 1" thick shelves
- MVB5 supports 75 lbs. per shelf, evenly distributed
- MVBQ2 supports 25 lbs. per shelf, evenly distributed

Model No.	Description	Dimensions	Weight	List Price
MVB5	5 Shelf	36"W x 13"D x 68"H	145	1,027.00
MVBQ2	2 Shelf ¼ - Round	20"W x 20"D x 29½"H	36	378.00

REPLACEMENT LOCK CORES



- Allows pedestals and laterals to be keyed uniquely for up to ten different workstations
- Master key available
- Must purchase a core removal tool to change locks cores

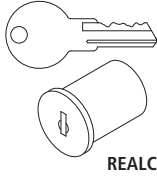

Model No.	Description	Weight	List Price
REALCC0311 through REALCC0325 (Silver)	Replacement Core with Keys	1	42.00
REALCRK	Core Removal Tool	1	42.00
REALCMK	Master Key	1	42.00

MEDINA CONFERENCE TABLES



Laminate Options: Gray Steel-LGS, Mocha-LDC and Textured Sea Salt-TSS

- Cutout designed to support PM33 listed below
- 250 lb. weight capacity
- Grommet hole cutout size is 4 x 8"
- Conference table legs have cable chimney for concealed cable management from surface to floor



Model No.	Description	Dimensions	Weight	List Price
MNCR48	Round Conference Table	48" Diameter x 29½" H	135	1,045.00
MNC8	8' Conference Table	96"W x 42"D x 29½" H	236	1,923.00
MNC10	10' Conference Table	120"W x 48"D x 29½" H	306	2,626.00
MNC12	12' Conference Table	144"W x 48"D x 29½" H	358	3,143.00
MNC14	14' Conference Table	168"W x 48"D x 29½" H	399	3,662.00
MNPB	Presentation Board	48"W x 48"H x 3¼"D	110	1,213.00

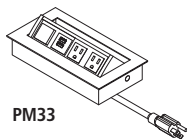
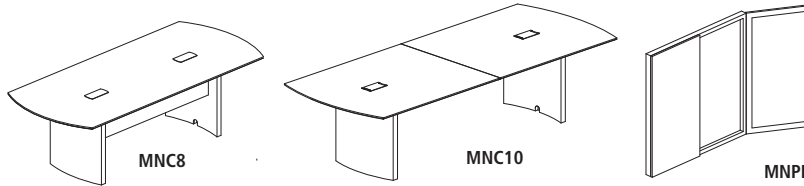

Model No.	Description	Weight	List Price
PM33	Power and USB Module with two Power and two USB Outlets (Black-BLK or Silver-SLV) add suffix BLK or SLV after model number (example: PM33BLK) Outside dimension: 8.33"w x 4.40"d, Inside: 6.60"w x 2.75"d	4	1,034.00

MEDINA RECEPTION FURNITURE



Laminate Options: Gray Steel-LGS, Mocha-LDC and Textured Sea Salt-TSS

- Universal Return
- ¾" frosted, tempered glass
- All Reception Station typicals include a center drawer

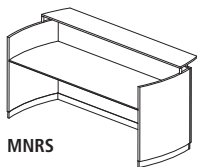

Model No.	Description	Dimensions	Weight	List Price
MNRS	Reception Station (No Pedestals)	87¼"W x 37¼"D x 42¾"H	360	4,827.00
MNRSBF	Reception Station with Box/Box/File, File/File	87¼"W x 37¼"D x 42¾"H	520	6,314.00
MNRSBFB	Reception Station with Return, Box/Box/File, File/File	87¼"W x 37¼"D x 42¾"H Desk 48"W x 25"D x 39¼"H Return	882	7,593.00
MNRBBF	Reception Box/Box/File (Pedestal only)	15½"W x 18"D x 27½"H	77	772.00
MNRFF	Reception File/File (Pedestal only)	15½"W x 18"D x 27½"H	75	712.00

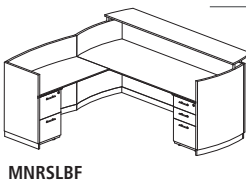

**MEDINA™ HEIGHT-ADJUSTABLE FRONT DESKS**

- Desks easily adjust from 29½" - 49¼"
- All work surfaces are 1" thick with a distinctive beveled edge and Silver detail
- All pieces coordinate with Medina™ Desking, Conference and Reception Furniture
- Drive System 110V, 60Hz AC input 120V DC motor draws a maximum of 3 amps for quick and easy movement
- Moves at a speed of ¾" per second for quick adjustment
- Control Switch has simple Up/Down Buttons; sold as standard for ease of reconfiguration
- **Laminate options:** Gray Steel-LGS, Mocha-LDC, Textured Sea Salt-TSS

**Medina™ Height-Adjustable Straight Front Desk**

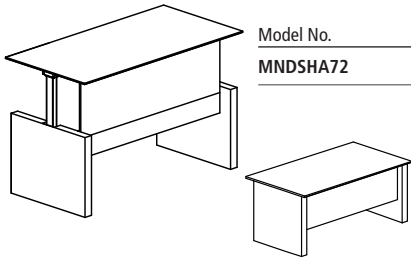

Model No.	Description	Dimensions	Weight	List Price
MNDSHA72	72" Straight Front Desk	72" W x 36" D x 29½" - 49¼" H	257	3,192.00

**Medina™ Height-Adjustable Straight Front Desk & Return**

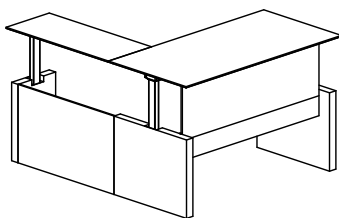

Model No.	Description	Dimensions	Weight	List Price
MNT51H	72" Straight Front Desk with Return	72" W x 84" D x 29½" - 49¼" H	364	4,415.00

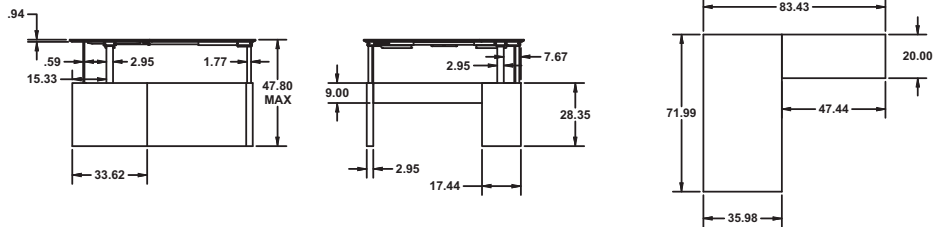

**SKINNY PEDESTAL**

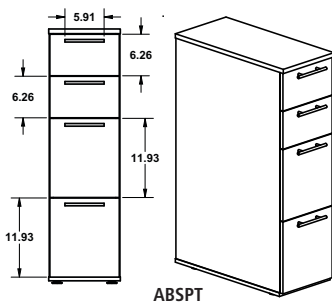

Model No.	Description	Dimensions	Weight	List Price
ABSP	Skinny Pedestal	10¼" W x 23" D x 25½" H	53	588.00
ABSPT	Skinny Pedestal (Tall)	10¼" W x 23" D x 38½" H	82	763.00

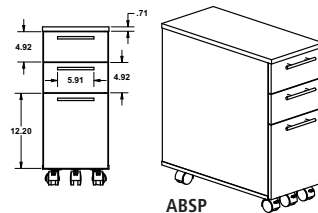

- Front 3 casters are 2" high locking casters
- Available in Medina™ laminate colors

# Medina™ Laminate Series Idea Starters

Safco® Products marketing materials are designed to be used as sales tools for our Dealer network.

• Order as components

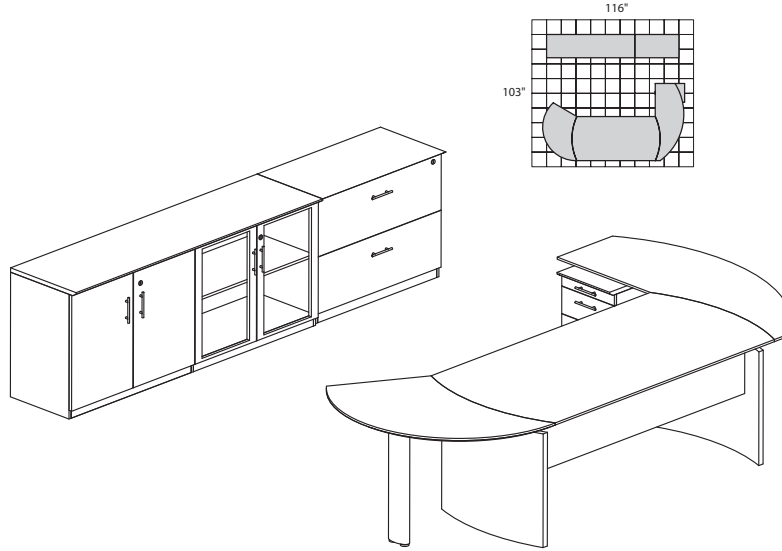

### MEDINA SERIES – IDEA STARTER #1

Consists of:

QTY.	MODEL NO.	DESCRIPTION	LIST PRICE EACH
1	MND72	72"W Desk	1,175.00
1	MNEXTR	Curved Desk Extension	712.00
1	MNRTPL	Curved Desk Return with P/B/F Pedestal	1,257.00
1	ACD	Center Drawer	299.00
1	MVLC	Low Wall Cabinet	1,707.00
1	MVLF	Lateral File	1,468.00
			<b>6,618.00</b>

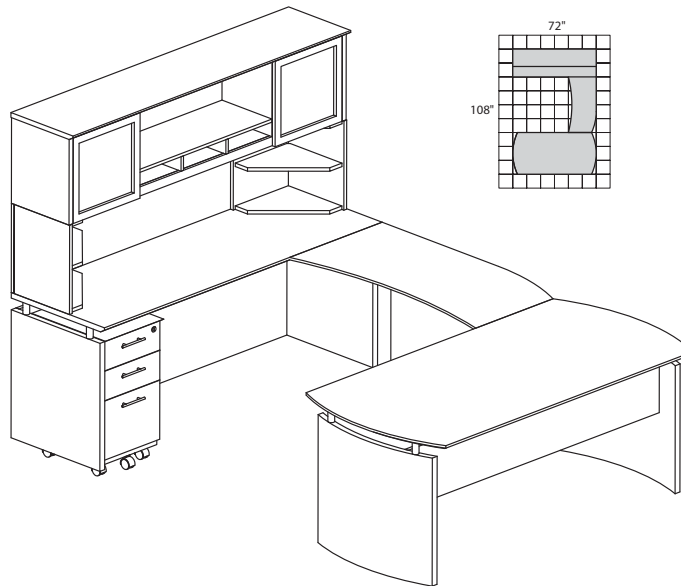

### MEDINA SERIES – IDEA STARTER #2

Consists of:

QTY.	MODEL NO.	DESCRIPTION	LIST PRICE EACH
1	MND72	72"W Desk	1,175.00
1	ACD	Center Drawer	299.00
1	MNBDGL	Bridge Left-Hand	590.00
1	MNCNZ72	72"W Credenza	765.00
1	MNH72	72"W Hutch	1,409.00
1	MNBBF	Box/Box/File Pedestal	772.00
2	MNPO	Corner Supports	191.00
			<b>5,392.00</b>

The Mirella™ laminate Desking series has a contemporary design with finishes and accents that provide a residential look

- Desks and Credenzas feature a floating 1½" thick work surface on top of Black or Silver Standoffs (color based on laminate option)
- Desks and Credenzas feature decorative corner accents and double pedestal design
- Pedestal has option of integrated power module with 2 USB ports in top drawer, power module sold separately
- Pedestal comes keyed alike; for additional keying options contact Safco® Customer Care
- Available in **Standard Laminate:** Sand Dune-SDD, Southern Tobacco-STO laminate  
**Premium Laminate:** White Ash-WAH or White Ash with Stone Gray-SGY (work surface)
- Brushed Silver legs and accents for Stone Gray and White Ash options; Black powder coat legs and accents for Sand Dune and Southern Tobacco
- Refer to Mirella Spec Guide for additional configurations which must be ordered as components

**FREESTANDING DESKS**

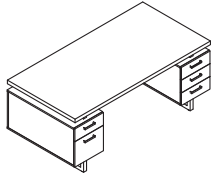

- Double pedestal design with Box/Box/Box and Box/File style
- Includes center drawer under desktop surface
- Includes laminate modesty panel for privacy

Model No.	Description	Dimensions	List Price	
			Standard Laminate	Premium Laminate
MRDBF7236	Double Pedestal Desk, BBB/BF	72"W x 36"D x 29½"H	3,041.00	3,134.00

**FREESTANDING CREDENZAS**

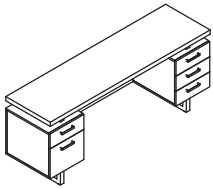

- Highly configurable with multiple pedestal options available
- Includes modesty panel

Model No.	Description	Dimensions	List Price	
			Standard Laminate	Premium Laminate
MRCBF7220	Double Pedestal Credenza, BBB/BF	72"W x 20"D x 29½"H	2,106.00	2,247.00

**L-SHAPED CONFIGURATIONS**



- Use Non-Handed Return Configuration to create a 'L' workstation
- Includes modesty panel
- Includes center drawer under desktop surface
- Includes pedestal with BBB/BF/False design options

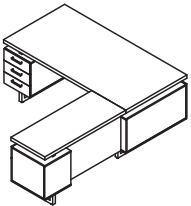

Model No.	Description	Dimensions	List Price	
			Standard Laminate	Premium Laminate
MRLSBF7236	Double Pedestal Desk, BBB/BF with 42"W Return	72"W x 36"D x 29½"H Desk 42"W x 20"D x 29½"H Return	3,845.00	3,922.00

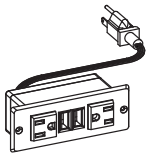

MRPM

MRPM	Power Module with 2 Power and 2 USB Outlets		-	165.00
------	---	--	---	--------



# Mirella™ Laminate Series

Safco® Products marketing materials are designed to be used as sales tools for our Dealer network.

## HUTCHES

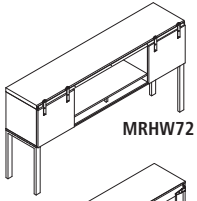

MRHW72

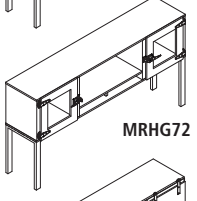

MRHG72

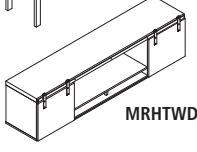

MRHTWD72

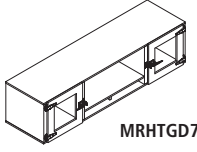

MRHTGD72

- Hutches come with the choice of smoked or frosted glass doors with decorative hinges and latches or wood doors with sliding barn door hardware
- Available in Standard Laminate Southern Tobacco-STO, Sand Dune-SDD and Premium Laminate White Ash-WAH
- Frosted glass doors for White Ash-WAH, Smoked glass door for Southern Tobacco-STO and Sand Dune-SDD

Model No.	Description	Dimensions	List Price Standard Laminate	List Price Premium Laminate
<b>Hutch with Supports</b>				
MRHW72	72" Hutch with Sliding Wood Doors	72"W x 15"D x 38"H	1,217.00	1,279.00
MRHG72	72" Hutch with Glass Doors	72"W x 15"D x 38"H	1,430.00	1,499.00

### Wall Mounted Hutches

MRHTWD72	72" Hutch with Sliding Wood Doors	72"W x 15"D x 18"H	809.00	853.00
MRHTGD72	72" Hutch with Glass Doors	72"W x 15"D x 18"H	1,021.00	1,070.00

NOTE: Recommended under-cabinet LED Task Light is model EZDP.  
Other LED Task/Desk lighting is available in the Ergonomics section page 143.

## STORAGE OPTIONS

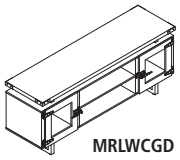

MRLWCGD

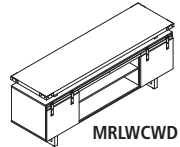

MRLWCWD

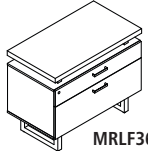

MRLF36

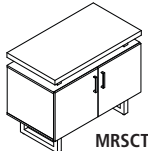

MRSCT36

- Low Wall Cabinets feature two cabinets and two open shelves for compartmentalized storage
- Low Wall Cabinets come with the choice of smoked or frosted glass doors with decorative hinges and latches or wood doors with sliding barn door hardware
- Frosted glass doors for White Ash-WAH and Stone Gray-SGY (work surface), Smoked glass door for Southern Tobacco-STO and Sand Dune-SDD
- Lateral File includes one file drawer and one storage drawer
- Storage Cabinet (MRSC36) has one shelf with concealed storage
- Glass Door Display Cabinet (MRGDC) and Wood Door Storage Cabinet (MRWDC) include three storage shelves

Model No.	Description	Dimensions	List Price Standard Laminate	List Price Premium Laminate
MRLWCGD	Low Wall Cabinet Glass Doors	72"W x 20"D x 29½"H	2,089.00	2,228.00
MRLWCWD	Low Wall Cabinet Wood Doors	72"W x 20"D x 29½"H	2,089.00	2,089.00
MRLF36	36" Lateral File	36"W x 20"D x 29½"H	1,522.00	1,623.00
MRSCT36	36" Storage Cabinet	36"W x 20"D x 29½"H	1,337.00	1,404.00

### Display Cabinets - • Available in Standard Laminate Southern Tobacco-STO, Sand Dune-SDD and Premium Laminate White Ash-WAH

MRGDC	Glass Door Display Cabinet, sits on 36" cabinet	36"W x 20"D x 38"H	1,279.00	1,273.00
MRWDC	Wood Door Storage Cabinet, sits on 36" cabinet	36"W x 20"D x 38"H	1,006.00	1,006.00

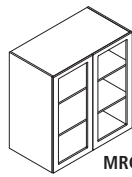

MRGDC

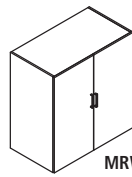

MRWDC

## Bookshelf

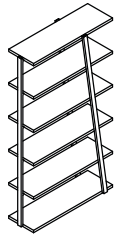

MRB55

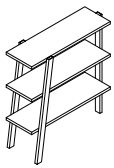

MRB53

- Three or five shelf bookcase with open back
- Three-legged design
- Available in Standard Laminate Southern Tobacco-STO, Sand Dune-SDD and Premium Laminate White Ash-WAH

MRB53	3 Shelf Bookshelf - 3 shelves, no bottom shelf. Product sits on 36" cabinet. All Shelves 1" thick	36"W x 13½"D x 38"H	577.00	598.00
MRB55	5 Shelf Bookshelf - all Shelves 1" thick With Levelers on the bottom.	36¾"W x 13½"D x 67½"H	963.00	993.00



**CONFERENCE ROOM TABLES**



MR42R

- Standing- or sitting-height options available
- All Conference tables features a 1 1/2" work surface
- Available: Standard Laminate Southern Tobacco-STO, Sand Dune-SDD and Premium Laminate White Ash-WAH, Stone Gray-SGY

- Brushed Silver legs and accents for White Ash and Stone Gray options; Black powder coat legs and accents for Southern Tobacco and Sand Dune

**Conference - Sitting**

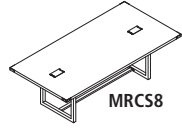

MRCS8

- Features a one-tier work surface with no floating top
- 2 cutouts and grommet covers included with 8 – 16' conference tables

- Cutout designed to work with the PM33 (PM33 is available in either Silver-SLV or Black-BLK)

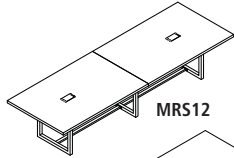

MRS12

Model No.	Description	Dimensions	List Price	
			Standard Laminate	Premium Laminate
MR42R	Mirella 42" Round Conference Top and Base	42" Diameter x 29 1/2" H	437.00	437.00
MRCS8	8 ft. Conference Table Sitting	96" W x 47 1/4" D x 29 1/2" H	2,298.00	2,365.00
MRS12	12 ft. Conference Table - Sitting	144" W x 47 1/4" D x 29 1/2" H	4,191.00	4,364.00
MRS16	16 ft. Conference Table - Sitting	192" W x 47 1/4" D x 29 1/2" H	4,990.00	5,204.00

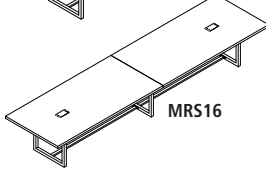

MRS16

PM33	Power Module with 2 Power and 2 USB Outlets (Silver or Black)		1,034.00	
------	---	--	----------	--



PM33

**Conference - Standing**

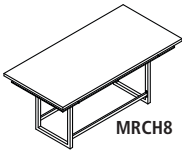

MRCH8

- Two – tier design (3 3/4" between tiers) allows for optional integrated power nested between tiers
- Table with 6 cutouts for power modules (sold separately) use with MRPM3
- MRPM3 includes three Power Modules per carton (1 standard and 2 daisy chain Power Modules)

Model No.	Description	Dimensions	List Price	
			Standard Laminate	Premium Laminate
MRCH8	8 ft. Conference Table Standing	96" W x 47 1/4" D x 42" H	2,880.00	3,073.00
MRH12	12 ft. Conference Table - Standing	144" W x 47 1/4" D x 42" H	5,351.00	5,709.00
MRH16	16 ft. Conference Table - Standing	192" W x 47 1/4" D x 42" H	6,663.00	6,860.00

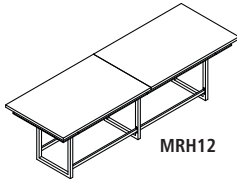

MRH12

MRPM3BLK	Power Module with 2 Power and 2 USB Outlets 1 Daisy Chain (3 Power Modules per carton), Black			456.00
----------	---	--	--	--------

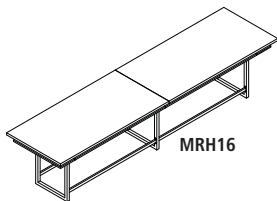

MRH16

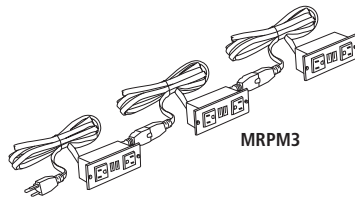

MRPM3

**OCCASIONAL TABLES**

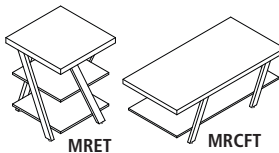

MRET

MRCFT

- Contemporary open design with slanted metal legs
- Bottom shelf for storage

Model No.	Description	Dimensions	List Price	
			Standard Laminate	Premium Laminate
MRET	End Table	20" W x 20" D x 25" H	708.00	756.00
MRCFT	Coffee Table	48" W x 23 3/4" D x 16" H	864.00	923.00

**RECEPTION STATIONS**

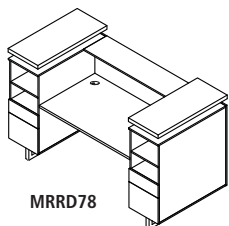

MRRD78

- Floating 1/2" thick tempered glass reception counter
- Frosted tempered glass top for White Ash options; Smoked glass top for Southern Tobacco & Sand Dune
- Available: Standard Laminate Southern Tobacco-STO, Sand Dune-SDD and Premium Laminate White Ash-WAH
- Features a floating 1 1/8" thick surface
- Has a 2 Shelf/Box/File Pedestals for storage
- Includes center drawer under desktop surface

Model No.	Description	Dimensions	List Price	
			Standard Laminate	Premium Laminate
MRRD78	Reception Desk with Counter Top Glass	78" W x 36" D x 48" H	4,716.00	4,800.00

- Order as components

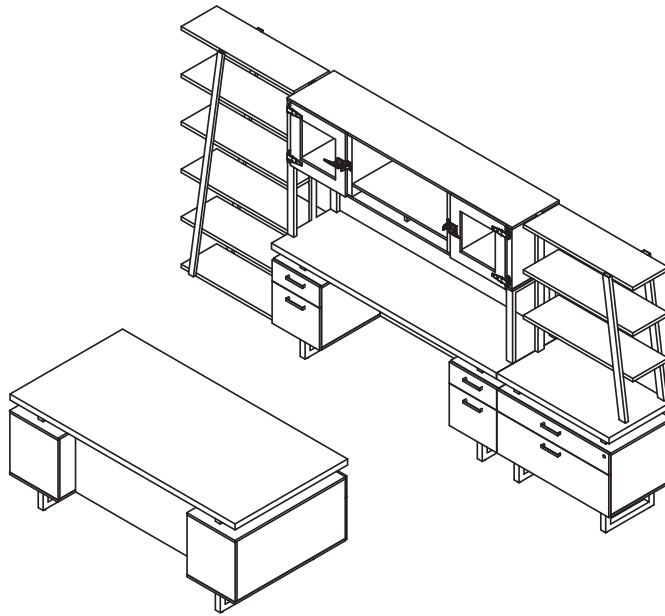

#### MIRELLA SERIES IDEA STARTER #2

Consists of:

QTY.	MODEL NO.	DESCRIPTION	LIST PRICE EACH
1	MRDBF7236	Double Pedestal Desk, BBB/BF 72"W x 36"D x 29½"H Desk	3,041.00
1	MRCBF7220	Double Pedestal Credenza, BBB/BF 72"W x 20"D x 29½"H	2,106.00
1	MRHG72	Hutch with Glass Doors 72"W x 20"D x 38"H	1,430.00
1	MRLF36	36"W Lateral File, 36"W x 20"D x 29½"H	1,522.00
1	MRBS3	3 Shelf Bookshelf, 36"W x 13½"D x 38"H	577.00
1	MRBS5	5 Shelf Bookshelf, 36¾"W x 13½"D x 67½"H	963.00
			<b>9,639.00</b>

Chrome stand-offs and opaque acrylic modesty panels and doors complement the laminate finishes.

**Laminate Options:** Textured Mocha-TDC, Textured Driftwood-TDW.

**CARB Compliant:** Core materials comply with Phase 2 of CARB's formaldehyde emission limits of composite wood materials.

**Double Pedestal Desk**

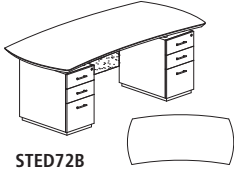

- 1½" thick surface with knife edge profile
- Stand-offs are chrome and ship with pedestals
- 1/2 height recessed acrylic modesty panel included
- Drawer pulls are standard in Chrome

Model No.	Description	Dimensions	Weight	List Price
STED72B	72" Desk with (2) Box/Box/File Pedestals	72"W x 39"D x 29½"H	253	3,531.00

**Double Pedestal Credenza**

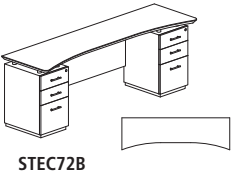

- 1½" thick surface with knife edge profile
- Drawer pulls are standard in Chrome
- Matching laminate modesty panel is recessed 2½" and provides 16¼" of knee clearance
- Stand-offs are Chrome and ship with pedestals

Model No.	Description	Dimensions	Weight	List Price
STEC72B	72" Credenza with (2) Box/Box/File Pedestals	72"W x 23"D x 29½"H	216	2,806.00
STEC72F	72" Credenza with (2) File/File Pedestals	72"W x 23"D x 29½"H	216	2,806.00

**Low Wall Cabinet**

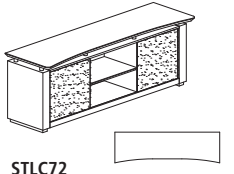

- 1½" thick surface with knife edge profile
- Features Acrylic doors that slide effortlessly in Aluminum door tracks
- Each cabinet compartment includes one shelf
- Shelves are adjustable in 1¼" increments
- Back panel features a mouse hole for wall access in each compartment
- Shelves contain corner mouse hole for vertical cable management

Model No.	Description	Dimensions	Weight	List Price
STLC72	72" Low Wall Cabinet with Acrylic Doors	72"W x 23"D x 29½"H	229	2,147.00

**Single Pedestal Desk**

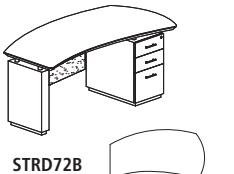

- 1½" thick surface with knife edge profile
- Stand-offs are chrome and ship with pedestals
- 1/2 height recessed acrylic modesty panel included
- Drawer pulls are standard in Chrome

Model No.	Description	Dimensions	Weight	List Price
STRD72B	72" Right Handed Desk with (1) Box/Box/File Pedestal	72"W x 36"D x 29½"H	195	2,570.00

**Single Pedestal Credenza**

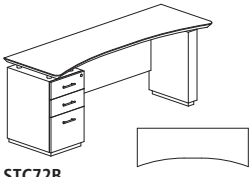

- 1½" thick surface with knife edge profile
- Stand-offs are Chrome and ship with pedestals
- 1/2 height recessed laminate modesty panel included
- Drawer pulls are standard in Chrome

Model No.	Description	Dimensions	Weight	List Price
STC72B	72" Credenza with (1) Box/Box/File Pedestals	72"W x 24"D x 29½"H	175	2,030.00

**Non-Handed Bridge**

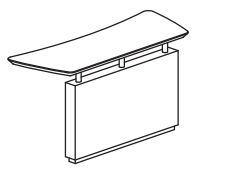

- 1½" thick surface with knife edge profile
- Non-handed, mounts to either left or right side of single pedestal Desk
- Not free-standing. Requires connection to single ped Desk and single ped Credenza
- Full height laminate modesty wall included

Model No.	Description	Dimensions	Weight	List Price
STEB	48" Curved Bridge	48"W x 21¼"D x 29½"H	76	780.00

# Sterling Series

Safco® Products marketing materials are designed to be used as sales tools for our Dealer network.

## Single Pedestal Desk Return

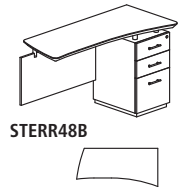

STERR48B

- 1½" thick surface with knife edge profile
- Stand-offs are Chrome and ship with pedestals

- 1/2 height recessed acrylic modesty panel included
- Drawer pulls are standard in Chrome

Model No.	Description	Dimensions	Weight	List Price
STERR48B	Right Handed Desk with (1) Box/Box/File Pedestal	48"W x 24"D x 29½"H	120	1,580.00
STERL48B	Left Handed Desk with (1) Box/Box/File Pedestal	48"W x 24"D x 29½"H	120	1,580.00

## Center Drawer

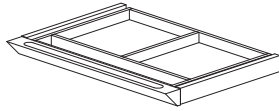

- Solid wood frame construction
- Drawer operates smoothly on full-extension ball bearing suspension

- Available in Graphite with Black drawer front only
- Compatible with Sterling Desks only
- Center Drawer will not work with Sterling Credenzas

Model No.	Description	Dimensions	Weight	List Price
ACD	Center Drawer	25"W x 18"D x 2"H	13	299.00

## Wall Mounted Hutch

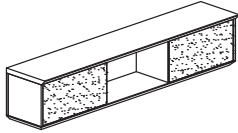

- Hutch comes with acrylic sliding doors
- Wall mounting brackets included

- Maximum 150 lb. weight capacity

Model No.	Description	Dimensions	Weight	List Price
STEH72	72" Wall Mounted Hutch with Acrylic Doors	72"W x 16½"D x 16½"H	148	1,357.00

## Hutch (Double)

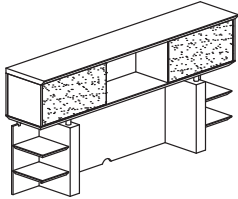

- Hutch ships fully assembled
- Designed for a double pedestal Credenza
- Features Acrylic doors that slide effortlessly in aluminum door tracks

- Hutch support comes with two multipurpose shelves on each side
- 1½" thick top treatment with knife edge detail

Model No.	Description	Dimensions	Weight	List Price
STEDPH72	72" Hutch with (2) Shelves	72"W x 16½"D x 41½"H	295	2,020.00

## Hutch (Single)

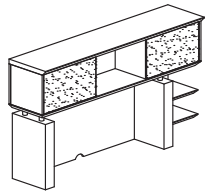

- Designed for a single pedestal Credenza
- Cabinet body ships fully assembled
- Features Acrylic doors that slide effortlessly in aluminum door tracks

- Unique design allows cabinet supports to be installed on either the left or the right
- 1½" thick top treatment with knife edge detail
- 24½" of clearance provided between work surface and cabinet bottom

Model No.	Description	Dimensions	Weight	List Price
STESPH72	72" Non-Handed Hutch	72"W x 16½"D x 41½"H	215	1,961.00

## STERLING SERIES MIX-N-MATCH STORAGE OPTIONS

### ABOVE SURFACE COMPONENTS

- 1½" thick top treatment with knife edge profile
- Each cabinet includes two (2) shelves
- Back panel features a mouse hole for wall access

- Door pulls are standard in Chrome
- Shelves are adjustable in 1¼" increments
- Shelves contain a cut in the corner for vertical cable management

### 3-Shelf Bookcase

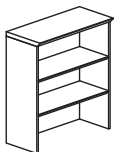

Model No.	Description	Dimensions	Weight	List Price
STSCB3	36" 3 Shelf Bookcase	35¾"W x 15½"D x 41½"H	89	766.00



**FREESTANDING STORAGE UNITS**

- Cabinets ship fully assembled. Top surface attaches easily with Chrome stand-offs
- Cabinets can support above surface storage components
- Each cabinet includes one (1) shelf (STELF has no shelf)
- Back panels feature a mouse hole for wall access (STELF has no wall access)
- All side edge profiles are straight
- Hand-crafted, 1 1/8" thick surfaces with knife edge profile
- Door/Drawer pulls are standard in Chrome
- Shelves are adjustable in 1/4" increments
- Shelves contain mouse hole for vertical cable management

**Lateral File**



- Locks are keyed alike

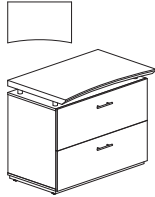

Model No.	Description	Dimensions	Weight	List Price
STELF	36" Freestanding 2 Drawer Lateral File	36"W x 23"D x 29 1/2"H	188	1,577.00

**REPLACEMENT LOCK CORES**



- Allows pedestals and laterals to be keyed uniquely for up to fifteen different workstations
- Master key available
- Must purchase a core removal tool to change locks cores

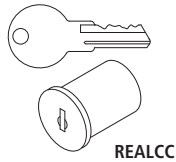

Model No.	Description	Weight	List Price
REALCC0311 through REALCC0325	Replacement Core with Keys, Silver	1	42.00
REALCRK	Core Removal Tool	1	42.00
REALCMK	Master Key	1	42.00

**STERLING CONFERENCE FURNITURE**



- Hand-Crafted, 1 1/8" thick surface with knife edge detail
- Conference table legs have cable chimney for concealed cable management from surface to floor
- Tables longer than 8' have multi-piece surfaces
- Surface and base ships separately

Model No.	Description	Dimensions	Weight	List Price
STC8	Sterling 8' Conference Table	96"W x 42"D x 29 1/2"H	183	2,508.00
STC10	Sterling 10' Conference Table	120"W x 48"D x 29 1/2"H	280	2,753.00
STC12	Sterling 12' Conference Table	144"W x 48"D x 29 1/2"H	342	3,386.00
STC14	Sterling 14' Conference Table	168"W x 48"D x 29 1/2"H	374	3,804.00
STC16	Sterling 16' Conference Table	192"W x 48"D x 29 1/2"H	428	4,559.00

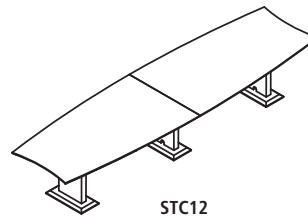
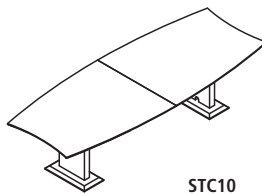
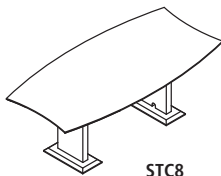

**Sterling Reception Furniture**

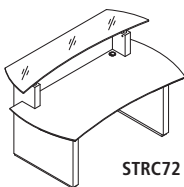

- 1/2" thick frosted glass transaction counter
- Hand-crafted, 1 1/8" thick surface with knife edge profile
- Reception Station comes with a center drawer
- Pedestals may be slid under surface for storage
- Free standing storage returns are available
- 72" Reception Station can use either one pedestal or one lateral file

Model No.	Description	Dimensions	Weight	List Price
STRC72	Sterling Reception - No Pedestals	72"W x 37 1/2"D x 42 3/4"H	313	3,562.00

# Sterling Series Idea Starters

Safco® Products marketing materials are designed to be used as sales tools for our Dealer network.

- Order as components

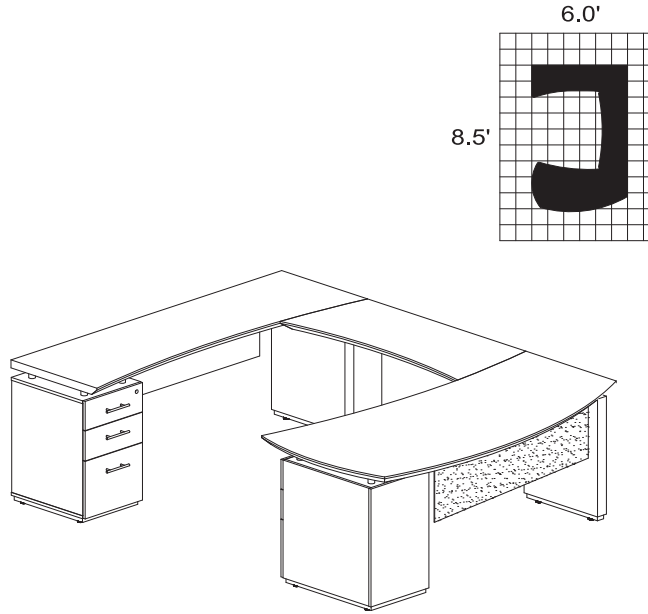

### STERLING IDEA STARTER #1

Consists of:

QTY.	MODEL NO.	DESCRIPTION	LIST PRICE EACH
1	STRD72B	72" Right Handed Desk with (1) B/B/F Pedestal	2,570.00
1	STEB	48" Curved Bridge	780.00
1	STC72B	72" Credenza with (1) B/B/F Pedestal	2,030.00
1	ACD	Center Drawer	299.00
			<b>5,679.00</b>

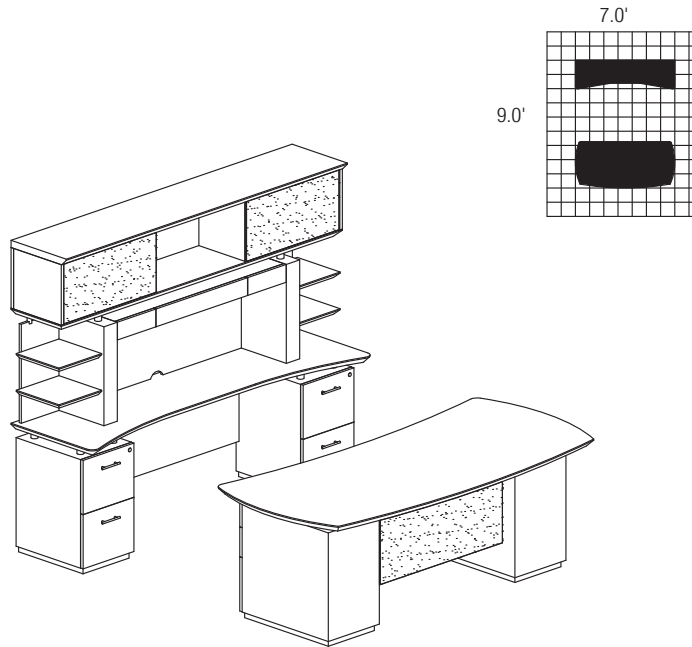

### STERLING IDEA STARTER #2

Consists of:

QTY.	MODEL NO.	DESCRIPTION	LIST PRICE EACH
1	STED72B	72" Desk with (2) B/B/F Pedestals	3,531.00
1	STEC72F	72" Credenza with (2) F/F Pedestals	2,806.00
1	ACD	Center Drawer	299.00
1	STEDPH72	72" Hutch with (2) Shelves	2,020.00
			<b>8,656.00</b>





All pedestals and legs are non-handed making specifications and installation simple with Desks featuring a full 30" of filing and/or storage space.

**Desks:** 29"H Desk-Height. Legs and modesty panels made from Cold Rolled Steel. Optional storage pedestals incorporated into base to reduce redundant components. Modesty panel full height on Desks – 2/3 height on Credenza. Modesty panel can be mounted flush or with 1½" inset. All Desks come standard with leveling glides and grommets.

**Work surfaces:** 1½" High pressure laminate with PVC T-mold and 3mm edging. Grommets are 1¾" diameter.

**Peds:** Full extension ball bearing slides on all drawers, with adjustable leveling glides, pencil tray and box file divider. Locks standard and allow for lock cores to be changed. Choose Box/Box/File or File/File style. Peds support both legal and letter width files.

**Overhead:** All steel cabinet body. Contoured door for aesthetics. Doors travel up and over top of unit using ball bearing slides. Standard locks are concealed under cabinet body and are core-removable to create keyed-alike suites. 13⅞" deep shelf is 20" above Desk. Options include: Soft close, tackboard and task light.

**Privacy Panels:** Hollow core privacy panels available in tackable fabric. Can be stacked or ganged. Panel heights can be combined for three levels of privacy, either 18", 27" or 36"H.

**Meets or exceeds all ANSI/BIFMA standards.**  
**All grommets, overhead door and stackable fabric panel trim will match the work surface edging color (Black, Taupe, Warm Gray & Ice Gray).**

• Work surfaces available in CSII™ colors, see page 10 for Safco corporate Laminates and Paint colors or go to Safco website to view color swatches

### 30" DEEP RECTANGULAR DESK

- Pedestal depth is 30"
- Choice of File/File (F/F) and/or Box/Box/File (B/B/F)
- 300 lb. capacity, evenly distributed
- Full height modesty panel included
- Two grommets in surface, standard
- Work surfaces available in five colors; see Safco website for color information
- See page 41 for interior leg panel information

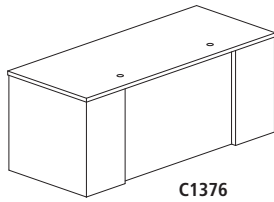

Model No.	Dimensions	Weight	List Price	No Modesty Panel (+N) List Price
C1336	48"W x 30"D x 29"H, No Pedestal	114	1,268.00	1,168.00
C1356	60"W x 30"D x 29"H, No Pedestal	124	1,498.00	1,287.00
C1366	66"W x 30"D x 29"H, No Pedestal	132	1,478.00	1,446.00
C1376	72"W x 30"D x 29"H, No Pedestal	142	1,608.00	1,342.00

#### 30" Deep Rectangular with one Pedestal

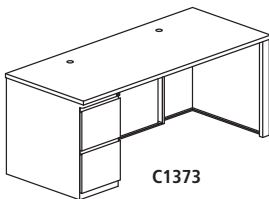

Model No.	Dimensions	Weight	List Price	No Modesty Panel (+N) List Price
C1331	48"W x 30"D x 29"H, 1 B/B/F Pedestal	157	2,114.00	2,206.00
C1341	54"W x 30"D x 29"H, 1 B/B/F Pedestal	162	2,345.00	2,239.00
C1351	60"W x 30"D x 29"H, 1 B/B/F Pedestal	167	2,430.00	2,302.00
C1361	66"W x 30"D x 29"H, 1 B/B/F Pedestal	175	2,502.00	2,366.00
C1371	72"W x 30"D x 29"H, 1 B/B/F Pedestal	185	2,528.00	2,239.00
C1333	48"W x 30"D x 29"H, 1 F/F Pedestal	157	2,114.00	2,206.00
C1343	54"W x 30"D x 29"H, 1 F/F Pedestal	162	2,345.00	2,239.00
C1353	60"W x 30"D x 29"H, 1 F/F Pedestal	167	2,216.00	2,302.00
C1363	66"W x 30"D x 29"H, 1 F/F Pedestal	175	2,282.00	2,366.00
C1373	72"W x 30"D x 29"H, 1 F/F Pedestal	185	2,528.00	2,394.00

• Work surfaces available in CSII™ colors, see page 10 for Safco corporate Laminates and Paint colors or go to Safco website to view color swatches

**30" DEEP RECTANGULAR DESK**

**30" Deep Rectangular with Two Pedestals**

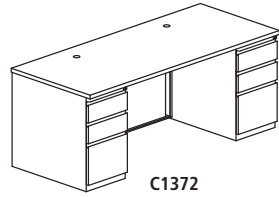

C1372

Model No.	Dimensions	Weight	List Price	No Modesty Panel (+N) List Price
C1342	54"W x 30"D x 29"H, 2 B/B/F Pedestals	175	3,228.00	3,218.00
C1352	60"W x 30"D x 29"H, 2 B/B/F Pedestals	180	3,401.00	3,278.00
C1362	66"W x 30"D x 29"H, 2 B/B/F Pedestals	190	3,476.00	3,336.00
C1372	72"W x 30"D x 29"H, 2 B/B/F Pedestals	200	3,505.00	3,070.00
C1345	54"W x 30"D x 29"H, 1 B/B/F Pedestal, 1 F/F Pedestal	175	3,325.00	3,218.00
C1355	60"W x 30"D x 29"H, 1 B/B/F Pedestal, 1 F/F Pedestal	180	3,401.00	3,278.00
C1365	66"W x 30"D x 29"H, 1 B/B/F Pedestal, 1 F/F Pedestal	190	3,170.00	3,336.00
C1375	72"W x 30"D x 29"H, 1 B/B/F Pedestal, 1 F/F Pedestal	200	3,505.00	3,367.00

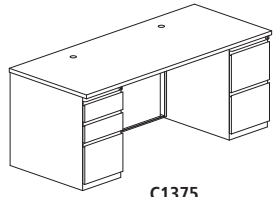

C1375

C1344	54"W x 30"D x 29"H, 2 F/F Pedestals	175	3,325.00	3,218.00
C1354	60"W x 30"D x 29"H, 2 F/F Pedestals	180	3,101.00	3,278.00
C1364	66"W x 30"D x 29"H, 2 F/F Pedestals	190	3,476.00	3,336.00
C1374	72"W x 30"D x 29"H, 2 F/F Pedestals	200	3,196.00	3,367.00

**36" DEEP RECTANGULAR DESK**

- 6" conference overhang
- Full height modesty panel included

- Two grommets in surface, standard
- See page 41 for interior leg panel information

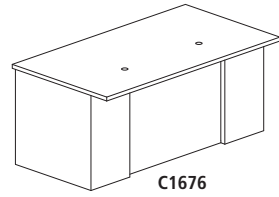

C1676

Model No.	Dimensions	Weight	List Price	No Modesty Panel (+N) List Price
C1656	60"W x 36"D x 29"H, No Pedestal	139	1,638.00	—
C1676	72"W x 36"D x 29"H, No Pedestal	157	1,737.00	1,596.00

**36" Deep Rectangular with One Pedestal**

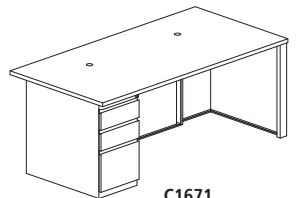

C1671

Model No.	Dimensions	Weight	List Price	No Modesty Panel (+N) List Price
C1651	60"W x 36"D x 29"H, 1 B/B/F Pedestal	180	2,250.00	2,345.00
C1661	66"W x 36"D x 29"H, 1 B/B/F Pedestal	190	2,356.00	2,389.00
C1671	72"W x 36"D x 29"H, 1 B/B/F Pedestal	200	2,615.00	2,259.00
C1653	60"W x 36"D x 29"H, 1 F/F Pedestal	180	2,468.00	2,345.00
C1663	66"W x 36"D x 29"H, 1 F/F Pedestal	190	2,520.00	2,389.00
C1673	72"W x 36"D x 29"H, 1 F/F Pedestal	200	2,615.00	2,477.00

**36" Deep Rectangular with Two Pedestals**

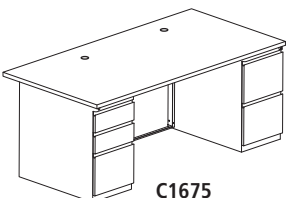

C1675

Model No.	Dimensions	Weight	List Price	No Modesty Panel (+N) List Price
C1652	60"W x 36"D x 29"H, 2 B/B/F Pedestals	187	3,490.00	3,367.00
C1662	66"W x 36"D x 29"H, 2 B/B/F Pedestals	202	3,547.00	3,406.00
C1672	72"W x 36"D x 29"H, 2 B/B/F Pedestals	217	3,635.00	3,501.00
C1655	60"W x 36"D x 29"H, 1 B/B/F Pedestal, 1 F/F Pedestal	187	3,490.00	3,367.00
C1665	66"W x 36"D x 29"H, 1 B/B/F Pedestal, 1 F/F Pedestal	202	3,547.00	3,406.00
C1675	72"W x 36"D x 29"H, 1 B/B/F Pedestal, 1 F/F Pedestal	217	3,399.00	3,501.00
C1654	60"W x 36"D x 29"H, 2 F/F Pedestals	187	3,490.00	3,367.00
C1664	66"W x 36"D x 29"H, 2 F/F Pedestals	202	3,547.00	3,406.00
C1674	72"W x 36"D x 29"H, 2 F/F Pedestals	217	3,315.00	3,501.00

**39" DEEP BOW FRONT DESK**

- Flush Modesty = 9" overhang, Recessed Modesty = 10¼" overhang
- See page 41 for interior leg panel information
- Full height modesty panel included
- Two grommets in surface, standard

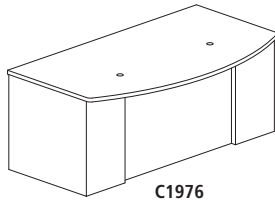

C1976

Model No.	Dimensions	Weight	List Price	No Modesty Panel (+N) List Price
C1956	60"W x 39"D x 29"H, No Pedestal	140	1,742.00	—
C1976	72"W x 39"D x 29"H, No Pedestal	160	1,906.00	1,773.00

**39" Bow Front Desk with One Pedestal**

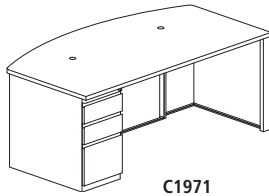

C1971

Model No.	Dimensions	Weight	List Price	No Modesty Panel (+N) List Price
C1951	60"W x 39"D x 29"H, 1 B/B/F Pedestal	190	2,704.00	2,582.00
C1961	66"W x 39"D x 29"H, 1 B/B/F Pedestal	205	2,625.00	2,674.00
C1971	72"W x 39"D x 29"H, 1 B/B/F Pedestal	220	2,860.00	2,722.00
C1953	60"W x 39"D x 29"H, 1 F/F Pedestal	190	2,528.00	2,582.00
C1963	66"W x 39"D x 29"H, 1 F/F Pedestal	205	2,807.00	2,674.00
C1973	72"W x 39"D x 29"H, 1 F/F Pedestal	220	2,860.00	2,722.00

**39" Bow Front Desk with Two Pedestals**

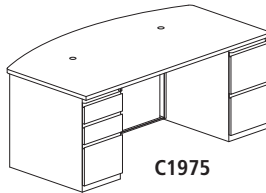

C1975

Model No.	Dimensions	Weight	List Price	No Modesty Panel (+N) List Price
C1952	60"W x 39"D x 29"H, 2 B/B/F Pedestals	225	3,723.00	3,601.00
C1962	66"W x 39"D x 29"H, 2 B/B/F Pedestals	235	3,578.00	3,692.00
C1972	72"W x 39"D x 29"H, 2 B/B/F Pedestals	245	3,627.00	3,743.00
C1955	60"W x 39"D x 29"H, 1 B/B/F Pedestal, 1 F/F Pedestal	225	3,481.00	3,601.00
C1965	66"W x 39"D x 29"H, 1 B/B/F Pedestal, 1 F/F Pedestal	235	3,578.00	3,692.00
C1975	72"W x 39"D x 29"H, 1 B/B/F Pedestal, 1 F/F Pedestal	245	3,879.00	3,743.00
C1954	60"W x 39"D x 29"H, 2 F/F Pedestals	225	3,723.00	3,601.00
C1964	66"W x 39"D x 29"H, 2 F/F Pedestals	235	3,827.00	3,692.00
C1974	72"W x 39"D x 29"H, 2 F/F Pedestals	245	3,879.00	3,743.00

**BRIDGES**

- Not freestanding, requires support from adjoining work surfaces
- Available as straight or contoured bridge
- Available with full, 2/3 height, or no modesty panel
- One grommet in surface, standard

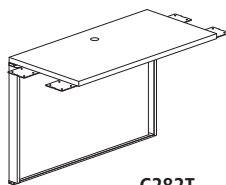

C282T

**Straight Bridge**

Model No.	Dimensions	Weight	List Price
C281T	36"W x 24"D x 29"H, Full Modesty Panel	50	703.00
C282T	42"W x 24"D x 29"H, Full Modesty Panel	57	742.00
C283T	48"W x 24"D x 29"H, Full Modesty Panel	65	728.00
C281S	36"W x 24"D x 29"H, 2/3 Modesty Panel	45	688.00
C282S	42"W x 24"D x 29"H, 2/3 Modesty Panel	53	725.00
C283S	48"W x 24"D x 29"H, 2/3 Modesty Panel	60	765.00

Continued on next page.

## BRIDGES

- Not freestanding, requires support from adjoining work surfaces

## Straight Bridge continued

Model No.	Dimensions	Weight	List Price
C281N	36"W x 24"D x 29"H, No Modesty Panel	40	652.00
C282N	42"W x 24"D x 29"H, No Modesty Panel	45	628.00
C283N	48"W x 24"D x 29"H, No Modesty Panel	50	712.00

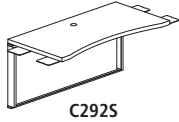

C292S

## Contour Bridge

Model No.	Dimensions	Weight	List Price
C292S	42"W x 24"D x 29"H, 2/3 Modesty Panel	53	757.00
C293S	48"W x 24"D x 29"H, 2/3 Modesty Panel	60	729.00

## HEIGHT-ADJUSTABLE BRIDGE

- Provides sit-to-stand adjustability at bridge location
- Travel Range: 16" of vertical adjustment from 26" to 42": Full travel time is 18 seconds
- Drive System: 110V, 60 H input, 24V DC motor. 150 lb. capacity  
Draws 1.2 amps under full load
- No modesty panel or grommet

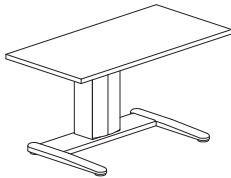

Model No.	Dimensions	Weight	List Price
C36A	36"W x 24"D	115	3,566.00
C42A	42"W x 24"D	119	3,595.00
C48A	48"W x 24"D	125	3,659.00

## RETURNS

- Used to create "L" return
- Available in 24"D or 30"D depths
- Returns are non-handed
- See page 41 for interior leg panel information
- Full height modesty panel included
- One grommet in surface, standard
- Must attach to a freestanding Desk unit

## 24" Deep Returns

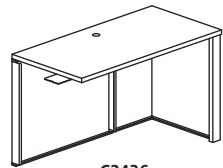

C2436

Model No.	Dimensions	Weight	List Price	No Modesty Panel (+N) List Price
C2486	24"W x 24"D x 29"H, No Pedestal	65	815.00	800.00
C2406	30"W x 24"D x 29"H, No Pedestal	70	851.00	—
C2416	36"W x 24"D x 29"H, No Pedestal	75	909.00	909.00
C2426	42"W x 24"D x 29"H, No Pedestal	82	1,066.00	956.00
C2436	48"W x 24"D x 29"H, No Pedestal	89	1,141.00	1,035.00
C2446	54"W x 24"D x 29"H, No Pedestal	96	1,312.00	1,205.00
C2456	60"W x 24"D x 29"H, No Pedestal	103	1,249.00	1,222.00
C2466	66"W x 24"D x 29"H, No Pedestal	110	1,464.00	1,314.00
C2476	72"W x 24"D x 29"H, No Pedestal	117	1,526.00	1,377.00

24" Deep with One Pedestal

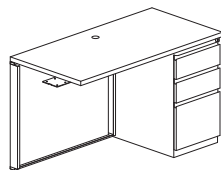

C2441

Model No.	Dimensions	Weight	List Price	No Modesty Panel (+N) List Price
C2481	24"W x 24"D x 29"H, 1 B/B/F Pedestal	94	1,659.00	1,678.00
C2401	30"W x 24"D x 29"H, 1 B/B/F Pedestal	99	1,833.00	1,739.00
C2411	36"W x 24"D x 29"H, 1 B/B/F Pedestal	104	1,771.00	1,799.00
C2421	42"W x 24"D x 29"H, 1 B/B/F Pedestal	111	1,973.00	1,865.00
C2431	48"W x 24"D x 29"H, 1 B/B/F Pedestal	118	1,917.00	1,940.00
C2441	54"W x 24"D x 29"H, 1 B/B/F Pedestal	125	2,157.00	1,865.00
C2451	60"W x 24"D x 29"H, 1 B/B/F Pedestal	132	2,268.00	2,118.00
C2461	66"W x 24"D x 29"H, 1 B/B/F Pedestal	139	2,345.00	2,197.00
C2471	72"W x 24"D x 29"H, 1 B/B/F Pedestal	146	2,207.00	2,271.00
C2483	24"W x 24"D x 29"H, 1 F/F Pedestal	94	1,774.00	1,678.00
C2403	30"W x 24"D x 29"H, 1 F/F Pedestal	99	1,671.00	1,739.00
C2413	36"W x 24"D x 29"H, 1 F/F Pedestal	104	1,894.00	1,799.00
C2423	42"W x 24"D x 29"H, 1 F/F Pedestal	111	1,973.00	1,865.00
C2433	48"W x 24"D x 29"H, 1 F/F Pedestal	118	2,050.00	1,940.00
C2443	54"W x 24"D x 29"H, 1 F/F Pedestal	125	1,967.00	2,046.00
C2453	60"W x 24"D x 29"H, 1 F/F Pedestal	132	2,068.00	1,931.00
C2463	66"W x 24"D x 29"H, 1 F/F Pedestal	139	2,345.00	2,197.00
C2473	72"W x 24"D x 29"H, 1 F/F Pedestal	146	2,421.00	2,271.00

30" Deep Returns

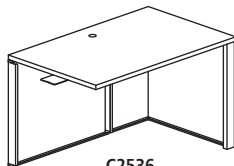

C2536

Model No.	Dimensions	Weight	List Price	No Modesty Panel (+N) List Price
C2506	30"W x 30"D x 29"H, No Pedestal	89	1,043.00	951.00
C2516	36"W x 30"D x 29"H, No Pedestal	94	1,121.00	—
C2526	42"W x 30"D x 29"H, No Pedestal	101	1,166.00	1,060.00
C2536	48"W x 30"D x 29"H, No Pedestal	109	1,169.00	1,139.00
C2546	54"W x 30"D x 29"H, No Pedestal	119	1,440.00	—
C2556	60"W x 30"D x 29"H, No Pedestal	123	1,493.00	1,348.00
C2566	66"W x 30"D x 29"H, No Pedestal	133	1,559.00	—
C2576	72"W x 30"D x 29"H, No Pedestal	141	1,562.00	—

30" Deep with One Pedestal

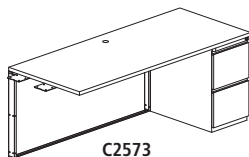

C2573

Model No.	Dimensions	Weight	List Price	No Modesty Panel (+N) List Price
C2581	24"W x 30"D x 29"H, 1 B/B/F Pedestal	123	1,887.00	1,791.00
C2501	30"W x 30"D x 29"H, 1 B/B/F Pedestal	128	1,823.00	1,853.00
C2511	36"W x 30"D x 29"H, 1 B/B/F Pedestal	133	1,881.00	1,915.00
C2521	42"W x 30"D x 29"H, 1 B/B/F Pedestal	140	2,096.00	1,981.00
C2531	48"W x 30"D x 29"H, 1 B/B/F Pedestal	147	2,165.00	2,056.00
C2541	54"W x 30"D x 29"H, 1 B/B/F Pedestal	153	2,336.00	2,230.00
C2551	60"W x 30"D x 29"H, 1 B/B/F Pedestal	162	2,197.00	2,263.00
C2561	66"W x 30"D x 29"H, 1 B/B/F Pedestal	170	2,502.00	2,352.00
C2571	72"W x 30"D x 29"H, 1 B/B/F Pedestal	180	2,484.00	2,507.00
C2583	24"W x 30"D x 29"H, 1 F/F Pedestal	123	1,887.00	1,791.00
C2503	30"W x 30"D x 29"H, 1 F/F Pedestal	128	1,777.00	1,853.00
C2513	36"W x 30"D x 29"H, 1 F/F Pedestal	133	1,881.00	1,915.00
C2523	42"W x 30"D x 29"H, 1 F/F Pedestal	140	2,096.00	1,981.00
C2533	48"W x 30"D x 29"H, 1 F/F Pedestal	147	2,165.00	2,056.00
C2543	54"W x 30"D x 29"H, 1 F/F Pedestal	153	2,336.00	2,230.00
C2553	60"W x 30"D x 29"H, 1 F/F Pedestal	162	2,409.00	2,263.00
C2563	66"W x 30"D x 29"H, 1 F/F Pedestal	170	2,502.00	2,352.00
C2573	72"W x 30"D x 29"H, 1 F/F Pedestal	180	2,657.00	2,507.00

# CSII™ Modular Desking

Safco® Products marketing materials are designed to be used as sales tools for our Dealer network.

Work surfaces available in CSII™ colors, see page 10 for Safco corporate Laminates and Paint colors or go to Safco website to view color swatches

## STAND ALONE CORNER SURFACE

- Corner units can be used as a freestanding Desk or as part of a larger configuration
- One grommet in surface, standard
- Full height modesty panels included
- See page 41 for interior leg panel information

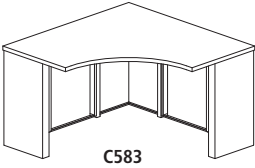

Model No.	Dimensions	Weight	List Price	No Modesty Panel (+N) List Price
C542	24"D x 42"W x 42"W x 24"D x 29"H	124	2,190.00	1,917.00
C552	30"D x 42"W x 42"W x 30"D x 29"H	129	2,238.00	—
C583	24"D x 48"W x 48"W x 24"D x 29"H	131	2,144.00	—
C593	30"D x 48"W x 48"W x 30"D x 29"H	143	2,398.00	—

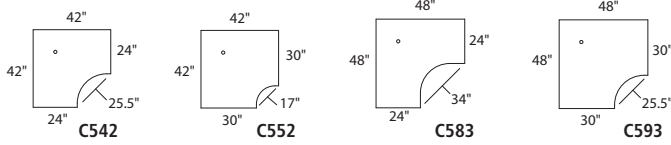

## 24" DEEP CREDENZA

- Pedestal depth is 24"
- Two grommets in surface, standard
- See page 41 for interior leg panel information
- 2/3 height modesty panel included
- F/F and/or B/B/F available
- Pedestals and legs are non-handed to allow installation on either left or right

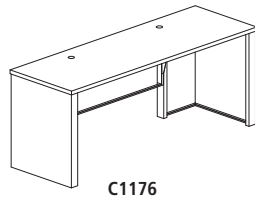

Model No.	Dimensions	Weight	List Price	No Modesty Panel (+N) List Price
C1136	48"W x 24"D x 29"H, No Pedestal	94	1,358.00	1,165.00
C1146	54"W x 24"D x 29"H, No Pedestal	101	1,440.00	—
C1156	60"W x 24"D x 29"H, No Pedestal	108	1,335.00	1,370.00
C1166	66"W x 24"D x 29"H, No Pedestal	115	1,423.00	1,425.00
C1176	72"W x 24"D x 29"H, No Pedestal	122	1,579.00	1,479.00

## CREDENZA WITH ONE PEDESTAL

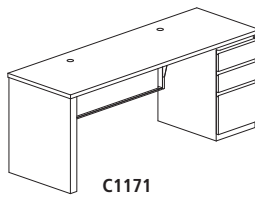

Model No.	Dimensions	Weight	List Price	No Modesty Panel (+N) List Price
C1131	48"W x 24"D x 29"H, 1 B/B/F Pedestal	130	2,109.00	2,171.00
C1141	54"W x 24"D x 29"H, 1 B/B/F Pedestal	137	2,293.00	2,210.00
C1151	60"W x 24"D x 29"H, 1 B/B/F Pedestal	144	2,345.00	2,249.00
C1161	66"W x 24"D x 29"H, 1 B/B/F Pedestal	151	2,261.00	2,324.00
C1171	72"W x 24"D x 29"H, 1 B/B/F Pedestal	158	2,487.00	2,397.00
C1133	48"W x 24"D x 29"H, 1 F/F Pedestal	130	2,056.00	2,171.00
C1143	54"W x 24"D x 29"H, 1 F/F Pedestal	137	2,293.00	2,210.00
C1153	60"W x 24"D x 29"H, 1 F/F Pedestal	144	2,345.00	2,249.00
C1163	66"W x 24"D x 29"H, 1 F/F Pedestal	151	2,261.00	2,324.00
C1173	72"W x 24"D x 29"H, 1 F/F Pedestal	160	2,487.00	2,397.00

**CREDENZA WITH TWO PEDESTALS**

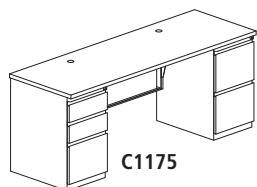

C1175

Model No.	Dimensions	Weight	List Price	No Modesty Panel (+N) List Price
C1142	54"W x 24"D x 29"H, 2 B/B/F Pedestals	178	3,242.00	3,163.00
C1152	60"W x 24"D x 29"H, 2 B/B/F Pedestals	185	3,296.00	3,210.00
C1162	66"W x 24"D x 29"H, 2 B/B/F Pedestals	192	3,366.00	3,256.00
C1172	72"W x 24"D x 29"H, 2 B/B/F Pedestals	204	3,437.00	3,329.00
C1145	54"W x 24"D x 29"H, 1 B/B/F Pedestal, 1 F/F Pedestal	178	2,956.00	3,163.00
C1155	60"W x 24"D x 29"H, 1 B/B/F Pedestal, 1 F/F Pedestal	185	3,005.00	3,210.00
C1165	66"W x 24"D x 29"H, 1 B/B/F Pedestal, 1 F/F Pedestal	192	3,069.00	3,256.00
C1175	72"W x 24"D x 29"H, 1 B/B/F Pedestal, 1 F/F Pedestal	204	3,214.00	3,036.00
C1144	54"W x 24"D x 29"H, 2 F/F Pedestal	178	3,242.00	3,163.00
C1154	60"W x 24"D x 29"H, 2 F/F Pedestal	185	3,082.00	3,210.00
C1164	66"W x 24"D x 29"H, 2 F/F Pedestal	187	3,366.00	3,256.00
C1174	72"W x 24"D x 29"H, 2 F/F Pedestal	199	3,214.00	3,036.00

**TILT TOP TABLES**

- Pencil stop standard in work surface
- Top may be positioned from 0° to 60° in 19 preset positions
- No grommet
- Interior leg panel cannot be used due to frame of tilt-top mechanism

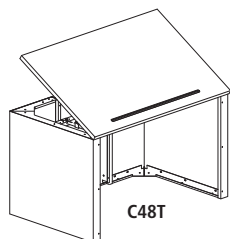

C48T

Model No.	Dimensions	Weight	List Price
C36T	36"W x 30"D x 29"H	130	2,181.00
C48T	48"W x 30"D x 29"H	150	2,589.00

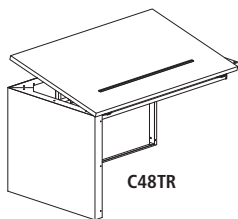

C48TR

Model No.	Dimensions	Weight	List Price
C36TR	36"W x 30"D x 29"H	110	2,103.00
C48TR	48"W x 30"D x 29"H	130	2,152.00

**END TEAM TABLES**

- Half round, team tables connect to two CSII™ Desks that are placed back to back
- Cannot be used when integrated pedestal is on Desk end as it is secured to Desk leg
- One grommet in surface, standard

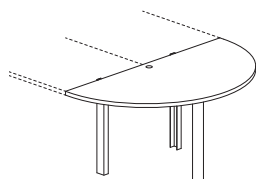

C515

Model No.	Dimensions	Weight	List Price
C523	25"W x 48"D x 29"H	85	1,296.00
C515	31"W x 60"D x 29"H	78	1,262.00



**PENINSULA FREESTANDING TABLE**

- Attaches to right or left side of bridges or returns
- No grommet
- Interior leg panel cannot be used due to unique "U" shaped leg

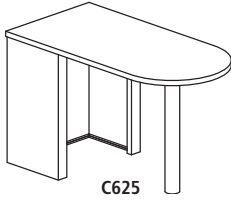

Model No.	Dimensions	Weight	List Price
C625	60"W x 24"D x 29"H	56	2,366.00
C627	72"W x 24"D x 29"H	106	2,872.00

**PENINSULA POST STYLE**

- Not freestanding, requires adjacent table
- Cannot be used when integrated pedestal is on Desk end
- No grommet

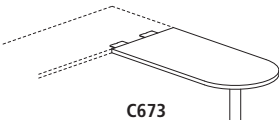

**24" Deep Peninsula Tables**

Model No.	Dimensions	Weight	List Price
C673	48"W x 24"D x 29"H	55	1,286.00

**30" Deep Peninsula Tables**

Model No.	Dimensions	Weight	List Price
C685	60"W x 30"D x 29"H	75	1,283.00

**J TABLES**

- Combines free standing worktable and corner unit into one unit
- "J" Tables can be used free standing or as part of a larger configuration
- Can be used in left/right configurations to create multi person work areas
- Allows for a very compact work area
- Right (R) and left (L) hand versions available
- Modesty panels included, 48" return side has full modesty panel, 72" side has 2/3 height modesty panel
- Two grommets in surface, standard
- See page 41 for interior leg panel information
- **Work surfaces available in CSII™ colors, see page 10 for Safco corporate Laminates and Paint colors or go to Safco website to view color swatches**

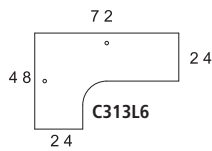

Model No.	Dimensions	Weight	List Price	No Modesty Panel (+N) List Price
C313L6	72"W x 48"D x 29"H x 24"D, Return Left, No Pedestal	175	2,385.00	2,384.00
C313R6	72"W x 48"D x 29"H x 24"D, Return Right, No Pedestal	175	2,385.00	2,384.00
C313L1	72"W x 48"D x 29"H x 24"D, Return Left with one B/B/F Pedestal	214	3,241.00	3,079.00
C313R1	72"W x 48"D x 29"H x 24"D, Return Right with one B/B/F Pedestal	214	3,241.00	2,807.00
C313L3	72"W x 48"D x 29"H x 24"D, Return Left with one F/F Pedestal	214	3,241.00	3,079.00
C313R3	72"W x 48"D x 29"H x 24"D, Return Right with one F/F Pedestal	214	3,241.00	3,079.00

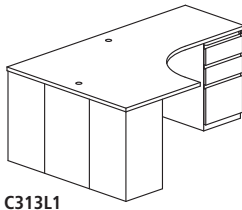

Model No.	Dimensions	Weight	List Price	No Modesty Panel (+N) List Price
C343L6	72"W x 48"D x 29"H x 30"D, Return Left, No Pedestal	175	2,326.00	2,384.00
C343R6	72"W x 48"D x 29"H x 30"D, Return Right, No Pedestal	175	2,326.00	2,384.00
C343L1	72"W x 48"D x 29"H x 30"D, Return Left with one B/B/F Pedestal	224	3,241.00	3,079.00
C343R1	72"W x 48"D x 29"H x 30"D, Return Right with one B/B/F Pedestal	224	3,241.00	3,079.00
C343L3	72"W x 48"D x 29"H x 30"D, Return Left with one F/F Pedestal	224	2,955.00	3,079.00
C343R3	72"W x 48"D x 29"H x 30"D, Return Right with one F/F Pedestal	224	3,241.00	3,079.00

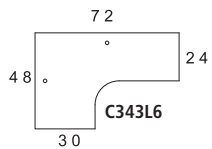

**P TABLES**

- The "P" Table combines a reference surface with a Peninsula Table
- Right (R) and left (L) hand versions available
- One grommet in surface, standard
- Allows for a very compact work area
- Full height modesty panel included

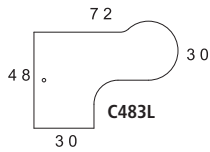

**• 30" D Return with Conference End**

Model No.	Dimensions	Weight	List Price	No Modesty Panel (+N) List Price
<b>C483L</b>	72"W x 48"D x 29"H x 30"D, Return Left Conference	152	2,576.00	2,384.00
<b>C483R</b>	72"W x 48"D x 29"H x 30"D, Return Right Conference	152	2,576.00	2,384.00

**INTERIOR LEG PANEL**

- Attaches to leg interior for a clean appearance
- Provides space to conceal cable management from surface to floor
- Easy Assembly – Adheres with magnetic tape

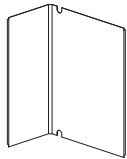

Model No.	Dimensions	Weight	List Price
<b>CL15</b>	11½"W x 11½"D x 27¼"H	9	236.00
<b>CL24</b>	11½"W x 20¼"D x 27¼"H	11	273.00
<b>CL30</b>	11½"W x 26½"D x 27¼"H	13	287.00

**PENCIL DRAWER**

- Attaches to underside of worksurface
- Full extension slides

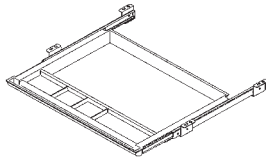

Model No.	Dimensions	Weight	List Price
<b>19400</b>	21"W x 16"D x 2"H	4	183.00

**GROMMETS**

- Available in Black-BK, Taupe-TP, Ice Gray-IG or Warm Gray-WG
- Field installed grommet holes required



Model No.	Dimensions	Weight	List Price
<b>F740</b>	2¾"W x 2⅞"D	1	39.00

**OVERHEAD OPEN SHELF**

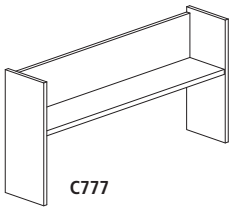

- All steel cabinet body
- Accepts optional Fabric Tack Panel and Task Light, see page 43
- 13 3/8" deep shelf is 20" above Desk

Model No.	Dimensions	Weight	List Price
C7721	42"W x 14"D x 36"H	55	1,015.00
C773	48"W x 14"D x 36"H	58	974.00
C775	60"W x 14"D x 36"H	65	1,052.00
C777	72"W x 14"D x 36"H	75	1,266.00

**OVERHEAD FLIPPER DOOR**

- All steel cabinet body
- 13 3/8" deep shelf is 20" above Desk
- Locks standard. Concealed under cabinet body and core removable
- Contoured door for aesthetics

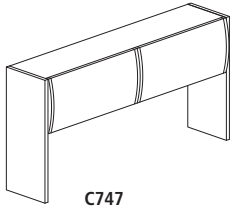

Model No.	Dimensions	Weight	List Price
C7421	42"W x 15"D x 36"H	80	1,378.00
C743	48"W x 15"D x 36"H	85	1,624.00
C745	60"W x 15"D x 36"H	103	2,008.00
C746	66"W x 15"D x 36"H	108	1,928.00
C747	72"W x 15"D x 36"H	115	2,237.00

- Door color matches accenting trim components (grommets, work surface T-mold and privacy panel kits). Available in Black-BK, Taupe-TP, Warm Gray-WG and Ice Gray-IG
- Accepts optional Fabric Tack Panel and Task Light, see page 43

**OVERHEAD FLIPPER DOOR WITH SOFT CLOSE FEATURE**

- Sold as a complete overhead unit
- Same specifications as Overhead Flipper Door
- Enhanced safety feature ensures controlled movement with pneumatic cylinder

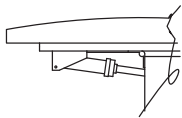

Model No.	Dimensions	Weight	List Price
C7621	42"W x 15"D x 36"H	80	1,858.00
C763	48"W x 15"D x 36"H	85	2,091.00
C765	60"W x 15"D x 36"H	103	2,441.00
C766	66"W x 15"D x 36"H	108	2,785.00
C767	72"W x 15"D x 36"H	115	2,903.00

**FABRIC TACK PANEL FOR OVERHEAD STORAGE UNITS**

- TackPanel attaches to overhead flipper door unit and overhead shelf
- Steel frame for mounting included
- Optional Tack Panel provides space at top and bottom for cabling
- Choose from 3 fabric options - Lido Heartland, Crosstown Ray and Bailey Khaki

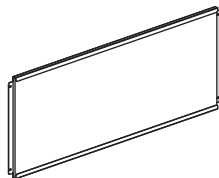

Model No.	Description	Dimensions	Weight	List Price
C8621	For use with 42" Overhead	39"W x 1/2"D x 17"H	18	543.00
C863	For use with 48" Overhead	45"W x 1/2"D x 17"H	21	549.00
C865	For use with 60" Overhead	57"W x 1/2"D x 17"H	23	607.00
C866	For use with 66" Overhead	63"W x 1/2"D x 17"H	25	637.00
C867	For use with 72" Overhead	69"W x 1/2"D x 17"H	27	690.00

**TASK LIGHTING**

- Task lighting attaches to overhead flipper door unit and overhead shelf
- Uses energy efficient 15W T8 bulb
- Includes the diffuser lens

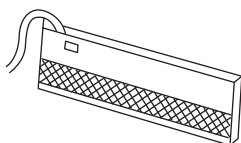

Model No.	Dimensions	Weight	List Price
1505TL	20"W x 8"D x 2"H	7	606.00

**KEYED ALIKE LOCK TUMBLERS**

Please read carefully to facilitate proper ordering or call Customer Care at 1-888-971-6225 for assistance.

CSII™ pedestals ship with keyed alike locks already installed. CSII overheads ship with randomly numbered paired locks (per overhead). To key alike suites of product, order the appropriate quantity of like numbered core kits for each workstation. Removable Core Kits include one core, two keys, one core removal tool and instructions. Removable Lock Core Kits available from CLCK3 through CLCK19.

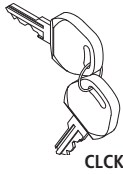

Model No.	Description	Weight	List Price
*CLCK3 through CLCK19	Removable Lock Core Kit	1	62.00
C88MKEYH	Master Key	1	30.00
Q618	Core Removal Tool	1	34.00

Note: Tumblers are specific to CSII peds, CSII overheads, lateral files and "P" style peds.  
\* Limited quantities available.

**PEDESTALS**

- Full width "J" style pulls
- Locks standard
- Supports letter and legal file widths
- Unique recessed base design allows casters to be added without adding additional height to the pedestal
- Full extension ball bearing slides
- Leveling glides have 5/8" of adjustability
- If not integrating pedestal as a leg, must order pedestal as follows – 24"D surface use 17½"D pedestal, 30", 36" and 39"D surfaces use 24"D pedestal
- Available in five colors: Putty-PUTY, Black-BLCK, Mist-MIST, Medium Tone-MDTN, and Desert Sage-DESA

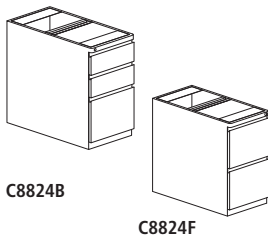

Model No.	Description	Weight	List Price
C8824B	15"W x 24"D x 28"H - B/B/F	65	1,191.00
C8824F	15"W x 24"D x 28"H - F/F	60	1,191.00
C8830B	15"W x 30"D x 28"H - B/B/F	75	1,228.00
C8830F	15"W x 30"D x 28"H - F/F	67	1,120.00
C8824M	24"D - Mobile Kit, includes steel top and casters	31	166.00
C8830M	30"D - Mobile Kit, includes steel top and casters	34	174.00

**CSII™ LATERAL FILES**

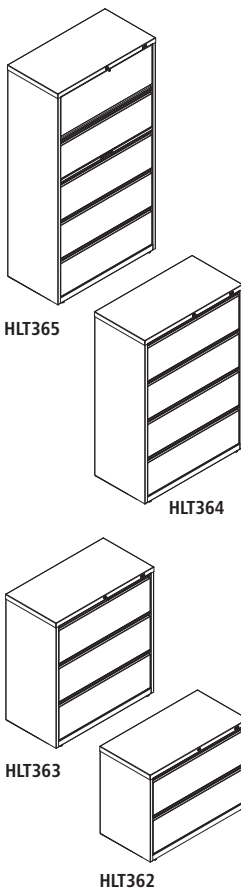

- All units feature anti-tipping drawer interlock system that allows only one drawer open at a time
- Full width recessed designer drawer pulls
- Side-to-side rails support letter, legal and/or A4 filing
- Top drawer of 5 Drawer Lateral is a roll out shelf
- Extendable posting shelf between third and fourth drawer on 5-Drawer Laterals
- All files ship keyed random
- Features adjustable leveling glides
- Counter weight included to meet ANSI/BIFMA stability requirements
- Optional Front-to-Back filing rails (4-pk) Black only
- Optional divider kit available (10-pk) Black only
- UL GREENGUARD certified
- Available in Black-BLCK, Medium Tone-MDTN, Desert Sage-DESA, and Mist-MIST

Model No.	Description	Dimensions	Weight	List Price
HLT425	42"W, 5-Drawer Lateral File	42"W x 18½"D x 67½"H	230	2,986.00
HLT365	36"W, 5-Drawer Lateral File	36"W x 18½"D x 67½"H	202	2,977.00
HLT305	30"W, 5-Drawer Lateral File	30"W x 18½"D x 67½"H	179	2,619.00
HLT424	42"W, 4-Drawer Lateral File	42"W x 18½"D x 52½"H	195	2,501.00
HLT364	36"W, 4-Drawer Lateral File	36"W x 18½"D x 52½"H	174	2,216.00
HLT304	30"W, 4-Drawer Lateral File	30"W x 18½"D x 52½"H	148	1,923.00
HLT423	42"W, 3-Drawer Lateral File	42"W x 18½"D x 40¼"H	173	1,916.00
HLT363	36"W, 3-Drawer Lateral File	36"W x 18½"D x 40¼"H	153	1,782.00
HLT303	30"W, 3-Drawer Lateral File	30"W x 18½"D x 40¼"H	133	1,626.00
HLT422	42"W, 2-Drawer Lateral File	42"W x 18½"D x 28"H	144	1,719.00
HLT362	36"W, 2-Drawer Lateral File	36"W x 18½"D x 28"H	123	1,471.00
HLT302	30"W, 2-Drawer Lateral File	30"W x 18½"D x 28"H	101	1,231.00
HLTFBR4	Front-to-Back Filing rails (4-pack)	1¾"W x 15¾"D x ¾"H	2½	88.00
HLTDV10	Divider kit (10-pack)	5"H x 12.88"D / per divider	8½	148.00
HMKEY	Master Key	—	1	18.00

Office Suites  
Seating  
Tables & Desks  
Meeting Essentials  
Personal Organization  
Ergonomics  
High Density Storage  
Storage & Filing  
Facilities  
Technology Furniture  
Art & Engineering  
Education  
K-12  
SAFE Collection Addendum

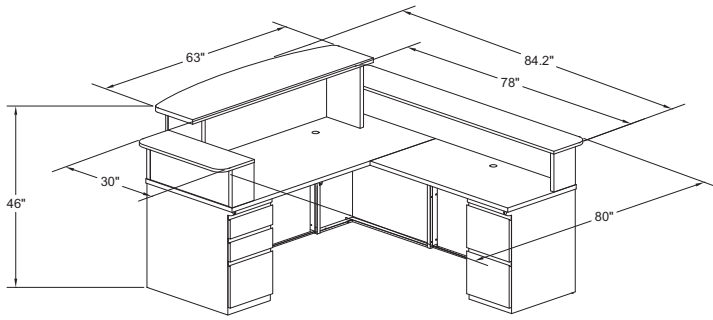

**CSII RECEPTION Desk TYPICAL – CST27**

Consists of:

QTY.	MODEL NO.	DESCRIPTION	LIST PRICE EACH
1	C1371	Rectangular Desk, 72 x 30" with 1 B/B/F	2,528.00
1	C2433	Return, 48 x 24" with 1 F/F	2,050.00
1	CS2RC	Reception Counter	1,597.00
1	CS2RS78	Reception Auxiliary Counter 78"W	1,062.00
1	CS2RS30	Reception Auxiliary Counter 30"W	759.00

**CST27 7,701.00**

**RECEPTION COUNTER**

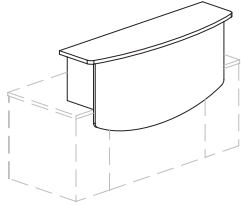

- For rectangular reception Desk. To be used on any 72"W x 30"D CSII™ Desk
- Laminate design
- 1½" thick bowfront transaction counter

Model No.	Description	Dimensions	Weight	List Price
CS2RC	Reception Counter	63"W x 18"D x 17¾"H (29"H overall)	115	1,597.00

**AUXILIARY COUNTER**

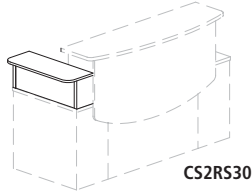

- 30" counter to be used with reception counter on any 72"W x 30"D CSII Desk
- 78" counter to be used with reception counter on any 72"W x 30"D CSII Desk and any 48"W CSII return
- All laminate design

Model No.	Description	Dimensions	Weight	List Price
CS2RS30	30" Auxiliary Counter	30"W x 12"D x 10¾"H	30	759.00
CS2RS78	78" Auxiliary Counter	78"W x 12"D x 10¾"H	80	1,062.00

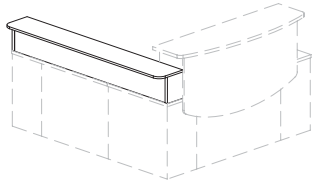

**Note:** CSII conference tables are found in "Tables" section page 108.

**CSII™ RECEPTION DESK TYPICALS**

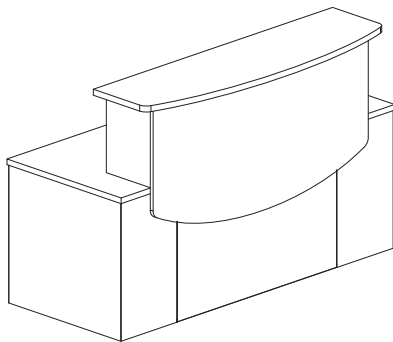

**CSII TYPICAL #25**

Consists of:

QTY.	MODEL NO.	DESCRIPTION	LIST PRICE EACH
1	C1375	Rect. Desk 72"W x 30"D with 1 B/B/F & 1 F/F Pedestal	3,505.00
1	CS2RC	Reception Counter	1,597.00

**CST25 5,212.00**

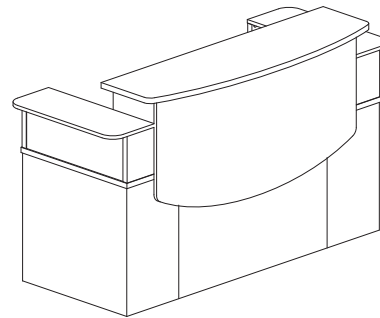

**CSII TYPICAL #26**

Consists of:

QTY.	MODEL NO.	DESCRIPTION	LIST PRICE EACH
1	C1375	Rect. Desk 72"W x 30"D with 1 B/B/F & 1 F/F Pedestal	3,505.00
1	CS2RC	Reception Counter	1,597.00
1	CS2RS30	Reception Auxiliary Shelf, 30"W	759.00
1	CS2RS30	Reception Auxiliary Shelf, 30"W	759.00

**CST26 6,390.00**

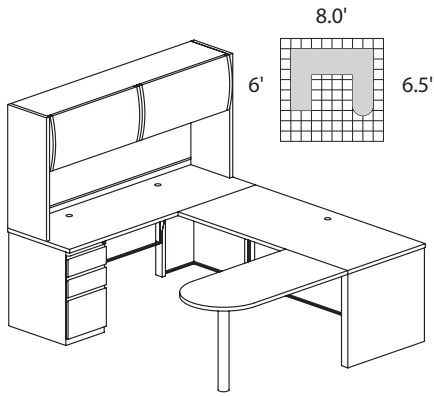

CSII TYPICAL #2

Consists of:

QTY.	MODEL NO.	DESCRIPTION	LIST PRICE EACH
1	C1171	Credenza 72"W x 24"D with One B/B/F	2,487.00
1	C2576	Return, 72"W x 30"D	1,562.00
1	C673	Peninsula Table, 48"W x 24"D	1,286.00
1	C747	Flipper Door Overhead Unit, 72"W x 15"D x 36"H	2,237.00
1	C867	Fabric Tack Panel for Overhead, 69¼"W x 17"H	690.00

**CST2 8,418.00**

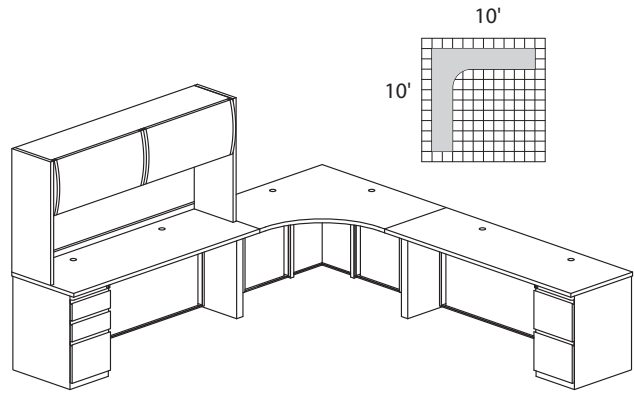

CSII TYPICAL #3

Consists of:

QTY.	MODEL NO.	DESCRIPTION	LIST PRICE EACH
1	C542	Corner Desk, 24"D x 42"W x 42"W x 24"D	2,190.00
1	C2471	Return 72 x 24" with One B/B/F	2,207.00
1	C2473	Return 72 x 24" with One F/F	2,421.00
1	C747	Flipper Door Overhead Unit, 72"W x 15"D x 36"H	2,237.00
1	C867	Fabric Tack Panel for Overhead, 69¼"W x 17"H	690.00

**CST3 9,960.00**

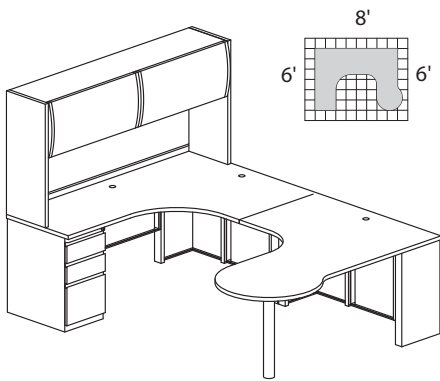

CSII TYPICAL #4

Consists of:

QTY.	MODEL NO.	DESCRIPTION	LIST PRICE EACH
1	C343R1	J Table 72"W x 48"D x 30"H, Return Right with One B/B/F	3,241.00
1	C483L	P Table 72"W x 48"D x 30"H, Return Left with Conference End	2,576.00
1	C747	Flipper Door Overhead Unit, 72"W x 15"D x 36"H	2,237.00
1	C867	Fabric Tack Panel for Overhead, 69¼"W x 17"H	690.00

**CST4 8,743.00**

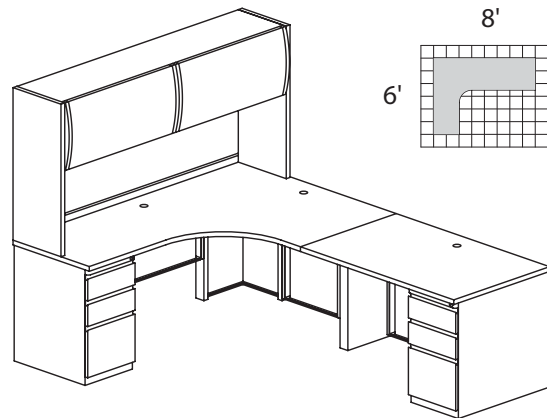

CSII TYPICAL #8

Consists of:

QTY.	MODEL NO.	DESCRIPTION	LIST PRICE EACH
1	C343R1	J Table 72"W x 48"D x 30", Return Right with One B/B/F	3,241.00
1	C2531	Return 48 x 30" with One B/B/F	2,165.00
1	C747	Flipper Door Overhead Unit 72"W x 15"D x 36"H	2,237.00
1	C867	Fabric Tack Panel for Overhead 69¼"W x 17"H	690.00

**CST8 7,791.00**

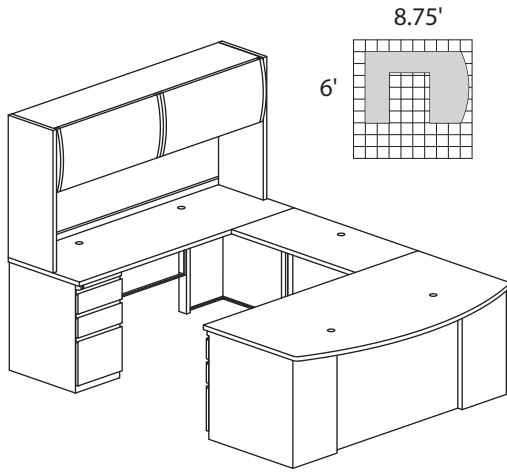

**CSII TYPICAL #5**

Consists of:  
**MODEL**

QTY.	NO.	DESCRIPTION	LIST PRICE EACH
1	C1971	Bowfront Desk 72 x 39" with One B/B/F	2,860.00
1	C282T	Straight Bridge, 42 x 21"	742.00
1	C1171	Credenza 72 x 24" with One B/B/F	2,487.00
1	C747	Flipper Door Overhead Unit, 72"W x 15"D x 36"H	2,237.00
1	C867	Fabric Tack Panel for Overhead, 69 1/4"W x 17"H	690.00

**CST5 9,016.00**

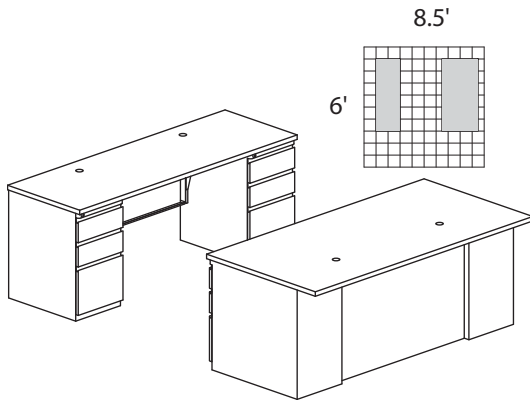

**CSII TYPICAL #7**

Consists of:  
**MODEL**

QTY.	NO.	DESCRIPTION	LIST PRICE EACH
1	C1675	Desk 72 x 36" with One B/B/F and One F/F	3,399.00
1	C1172	Credenza 72" x 24" with Two B/B/F	3,437.00

**CST7 7,076.00**

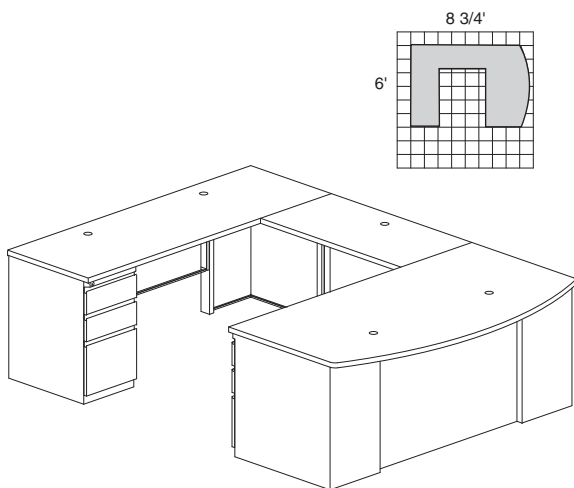

**CSII TYPICAL #9**

Consists of:  
**MODEL**

QTY.	NO.	DESCRIPTION	LIST PRICE EACH
1	C1971	Bowfront Desk 72"W x 39"D with One B/B/F	2,860.00
1	C1171	Credenza 72"W x 24"D with One B/B/F	2,487.00
1	C282T	Straight Bridge, 42"W x 24"D	742.00

**CST9 6,093.00**



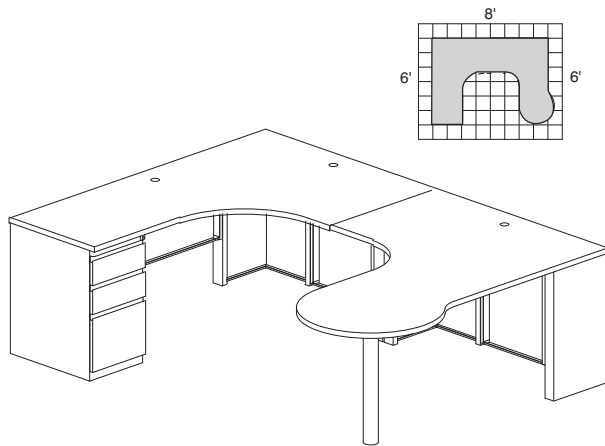

**CSII TYPICAL #10**

Consists of:

MODEL		LIST PRICE
QTY.	NO.	DESCRIPTION EACH
1	C343R1	J Table 72"W x 48"D x 30"D, Return Right with One B/B/F 3,241.00
1	C483L	P Table 72"W x 48"D x 30"D, Return Left w/Conference End 2,576.00
<b>CST10</b>		<b>5,819.00</b>

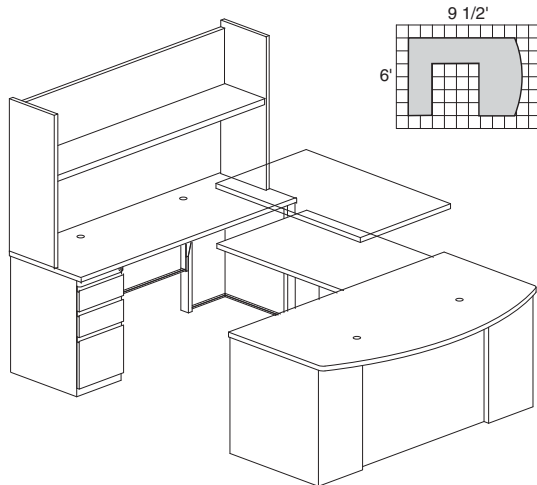

**CSII TYPICAL #14**

Consists of:

MODEL		LIST PRICE
QTY.	NO.	DESCRIPTION EACH
1	C1971	Bowfront Desk 72 x 39" with One B/B/F 2,860.00
1	C1171	Credenza 72 x 24" with One B/B/F 2,487.00
1	C48A	Height-Adjustable Bridge 48 x 24" 3,659.00
1	C777	Overhead Open Shelf, 72"W x 14"D x 36"H 1,266.00
1	C867	Fabric Tack Panel for Overhead, 69"W x 1/2"D x 17"H 690.00
<b>CST14</b>		<b>11,430.00</b>

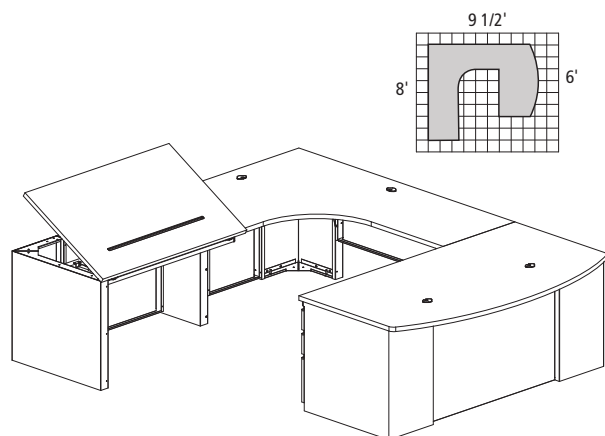

**CSII TYPICAL #24**

Consists of:

MODEL		LIST PRICE
QTY.	NO.	DESCRIPTION EACH
1	C1971	Bowfront Desk 72 x 39" with One B/B/F 2,860.00
1	C343L6	J Table 72"W x 48"D x 30"D, Return Left 2,326.00
1	C48TR	Tilt Top Return Table 48 x 30" 2,152.00
<b>CST24</b>		<b>7,027.00</b>

# Communication Station® Freestanding Worktables

Safco® Products marketing materials are designed to be used as sales tools for our Dealer network.

## FREESTANDING WORKTABLES

- Select Communication Station Freestanding Worktables for stand-alone applications are available
- Please refer back to the CSII™ section for all Desking accessories and storage features
- There is one wire management grommet at each end of 42", 48", 60" and 72" wide worktables and a wire port in each leg upright
- Modesty panel included. Legs are universal, left and right
- 24" deep worktables - Desk-height
- **Work surfaces available in CSII™ colors, see page 10 for Safco corporate Laminates and Paint colors or go to Safco website to view color swatches**

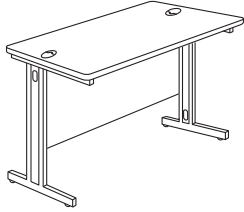

Model No.	Dimensions	Weight	List Price
243029	30"W x 24"D x 29½"H*	56	1,259.00
243629	36"W x 24"D x 29½"H*	62	1,339.00
244829	48"W x 24"D x 29½"H	76	1,593.00
246029	60"W x 24"D x 29½"H	91	1,747.00
247229	72"W x 24"D x 29½"H	107	1,960.00

\*No grommet on 30" and 36" widths. 30" wide worktables will not accept any keyboard options

## CORNER UNIT FOR 24" DEEP WORKSTATIONS

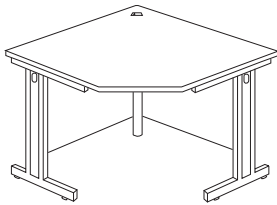

- Corner units can be used as freestanding worktables or as part of a larger configuration
- Connecting brackets included
- Grommet is provided at rear of unit
- Modesty panels are standard

Model No.	Dimensions	Weight	List Price
242229	42"W x 24"D x 29½"H	87	2,325.00

**Resi® Benching (Dual-Sided Workstations)**

- Perfect for open office environments that allow workers to collaborate, yet have an individual workspace for a touchdown spot or permanent workstation
- Maple wood legs and Wilsonart Designer White high-pressure laminate tops, with coordinating PVC edgbanding, complement the entire Resi Collection of products and most work environments
- Steel understructure adds support and stability
- Available in 2-person, 4-person, or 6-person configuration
- Work surfaces: Rectangle - 1 1/8" HPL in Designer White with coordinating PVC edgbanding
- Surfaces 30 x 60" with 4" gap between tabletops for privacy panel and accessories



RES2BEN3060WHNA



RES4BEN3060WHNA



RES6BEN3060WHNA

**Resi® 2-Person Benching** NEW

Model No.	Description	Dimensions	Weight	List Price
RES2BEN3060	RESI 2-Person Benching 30X60			
RES2BEN3060WHNA	2-Person Benching Unit	60 x 64 x 30"	162	2,717.00

**Resi® 4-Person Benching** NEW

Model No.	Description	Dimensions	Weight	List Price
RES4BEN3060	RESI 4-Person Benching 30X60			
RES4BEN3060WHNA	4-Person Benching Unit	120 x 64 x 30"	309	5,179.00

**Resi® 6-Person Benching** NEW

Model No.	Description	Dimensions	Weight	List Price
RES6BEN3060	RESI 6-Person Benching 30X60			
RES6BEN3060WHNA	6-Person Benching Unit	180 x 64 x 30"	449	7,640.00

**Resi® Privacy** NEW

- Optional accessories include Privacy Divider, Clamp On Privacy Units, Steel Organizer and Shelf (ordered separately)
- Accessories that are functional yet don't clutter workspaces provides opportunity to add personal style and enhance efficiencies
- Adds privacy, cable management, and organization to personal workspaces located in open office environments
- Privacy PET Divider is made of polyester fiber and provides a visual barrier between workstations

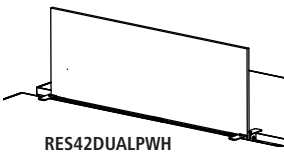

RES42DUALPWH

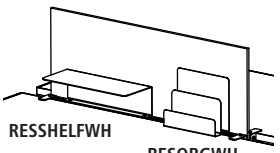

RESSHELFWH

RESORGWH

Model No.	Description	Dimensions	Weight	List Price
RES42SINGPWH	Single-Sided Privacy Unit	47 1/2 x 6 1/2 x 6 3/4"	13	433.00
RES42DUALPWH	Dual-Sided Privacy Unit	47 1/2 x 7 1/2 x 6 3/4"	18	577.00
RES2042PPSL	PET Privacy Divider	42 x 1/2 x 20"	2.8	177.00

**Accessories**

Model No.	Description	Dimensions	Weight	List Price
RESSHELFWH	Steel Shelf Accessory	18 x 7 1/2 x 5 1/4"	9	138.00
RESORGWH	Steel Organizer Accessory	11 x 3 3/8 x 9 1/2"	4	115.00

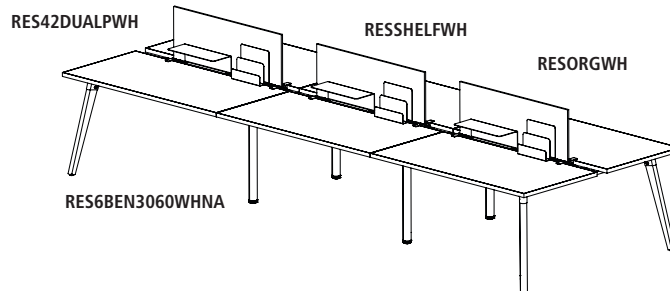

RES6BEN3060WHNA

# Power and Data & Handle Options

Safco® Products marketing materials are designed to be used as sales tools for our Dealer network.

All Power and Data Modules easily field install into Desk and conference table tops, providing a combination of power outlets and data jacks.

- Templates for field installation are included with each power module
- EZSCK available in Black, Silver and White
- Data jacks / couplers not included



Model No.	Description	Dimensions	Weight	List Price
PMR22	Power and Data Module with 2 Power and 2 Data Outlets (Black)	3"W x 4½"D x 8"H	2	319.00
PM20	Power Module with 2 Power Outlets (Black)	5½"W x 4¼"D	2	496.00
PM33	Power and USB Module with 2 Power and 2 USB Outlets (Silver or Black)	8¼"W x 4½"D	4	1,034.00
EZSCK	Flush Module with 2 power receptacles, 2 USB connectors and 108" plug-in cord	5¼"W x 2"D	6	734.00

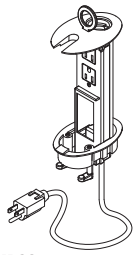

PMR22

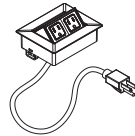

PM20

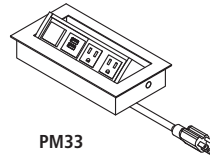

PM33

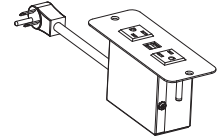

EZSCK

## GROMMET OPTIONS



- All grommets are field installed

Model No.	Description	Dimensions (Face Plate)	Weight	List Price
F740	Recommended for Desk Tops (Black, Taupe, Ice Gray or Warm Gray)	2¼"W x 2½"D	1	39.00
GMT1	Recommended for Conference Table and Desk Tops (Black)	3½"W x 2"D	1	42.00
GMT2	Recommended for Conference Tabletops (Black)*	6¼"W x 3¼"D	1	42.00
REALS099	Recommended for Conference Tabletops (Silver)*	6¼"W x 3¼"D	1	43.00
REALS100	Recommended for Conference Table and Desktops (Silver)	2½"D	1	43.00

\* Is not recommended for Corsica® Conference Tabletops



F740



GMT1

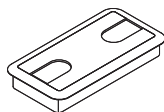

GMT2

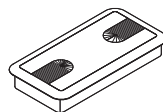

REALS099



REALS100



REALS104



REALS276

## HANDLE OPTION FOR DESKS AND STORAGE SERIES



Model No.	Description	Dimensions	Finish	List Price
REALS010	Napoli®*	7"W, with 6¼" Center	Satin Nickel	32.00
REALS011	Napoli®*	7"W, with 6¼" Center	Black	32.00
REALS191	Aberdeen®, Sorrento*	7"W, with 5" Center	Satin Nickel	32.00
REALS285	Aberdeen®, Sorrento*	6½"W, with 5" Center	Satin Nickel	39.00

\*Limited quantities available.



REALS010



REALS011



REALS191

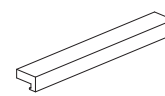

REALS285



There are many features to consider when selecting the perfect chair to suit your needs. The following symbols will help you choose the features that are right for you. These symbols are used throughout this pricer to help quickly identify each chair's features. The descriptions of the features shown are meant to be general explanations. The actual functions of the features may vary slightly between chair series.



### Seat Height Adjustment

Quick and easy adjustment regulates height of chair relative to the floor.



### Back Height Adjustment

Simple lift motion positions lumbar support within a fixed range to alleviate back stress.



### Seat Depth Adjustment

Positions chair back relative to seat reproducing pressure on the buttocks and thighs for both taller and shorter users.



### Seat Glide Mechanism

Seat cushion travels forward and back, then locks into position.



### 360° Swivel

Chair rotates a full 360° in either direction for ease of motion. Standard on every executive and task chair.



### Tilt

Pivot point located directly above center of chair base (White dot indicates pivot point).



### Mid-Range Knee Tilt

Pivot point located slightly ahead of center of chair base (White dot indicates pivot point). Allows user to recline at a slightly more relaxed angle than conventional center tilt.



### Side Tension

Controls rate and ease with which chair reclines to different weight and strength of users.



### Weight Sensitive Mechanism

Adjusts seat and back angles by sensing the user's body weight and reclines accordingly.



### Dual-Action Tilt

Back reclines at a 2-to-1 ratio to seat angle. Allows user to recline while keeping seat cushion relatively level to floor (White dot indicates pivot point).



### Tilt Tension

Controls rate and ease with which chair reclines to different weight and strength of users.



### Tilt Lock

Locks tilt function when chair is in upright position.



### Posture Lock

Back angle adjusts independently of seat, and can be locked in an infinite number of positions within a fixed range.



### Multi-Task Control

Adjusts seat and back angles with a single lever (infinite number of positions within a fixed range).



### Asynchronous Control

Three levers modify:

- Angle of back relative to seat
- Tilt (free float or infinite locking within a fixed range)
- Forward tilt (for keyboard intensive applications)



### Dual-Clutch Posture Control

Adjusts seat and back angles independently with two levers for infinite number of positions within a fixed range (White dot indicates pivot point).



### Variable Synchro-Tilt

Back reclines at a 2-to-1 ratio to seat. Chair can tilt freely, or lock in five positions. "Forward angle" control provides an extra 6° in the range of motion.



### Inverse Synchro-Tilt

With automatic tension control operation for better circulation. "Zero tilt" seat front helps keep feet on the floor when reclining. Tilt lever controls range of motion.

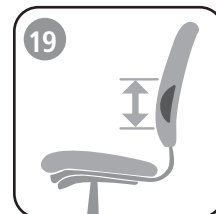

### Integral Lumbar Support

Easily adjust to enhance comfort.

## Arm Options

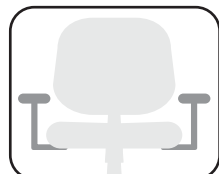

Fixed Position Arms



Loop Arms

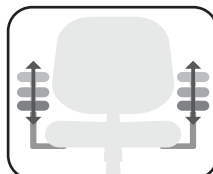

Adjustable-Height Arms

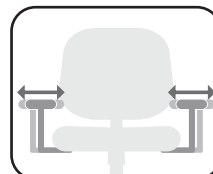

Adjustable-Width Arms

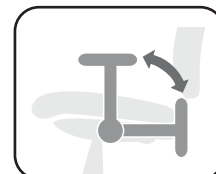

Breakaway Arms

# Seating - Fabric Grade Program

Safco® Products marketing materials are designed to be used as sales tools for our Dealer network.

Office Suites  
Seating  
Tables & Desks  
Meeting Essentials  
Personal Organization  
Ergonomics  
High Density Storage  
Storage & Filing  
Facilities  
Technology Furniture  
Art & Engineering  
K-12 Education  
SAFE Collection Addendum

## GRADE 01

### BANGLE - Momentum

- BE01 CORK
- BE02 GRANITE
- BE03 BALTIC
- BE04 ORCHID
- BE05 TEAK
- BE06 SUEDE
- BE07 SABLE

### BENDAY - CULP

- BN01 CHALK
- BN02 TIMBER
- BN03 BEACHGRASS
- BN04 SCAMPI
- BN05 RIVER
- BN06 NEWSPRINT

### CITY PARK - CULP

- CP01 BIRCH BARK
- CP02 CORK
- CP03 WALNUT
- CP04 KIWI
- CP05 MARIGOLD
- CP06 TOMATO
- CP07 BLUE MOON
- CP08 STEELY GRAY
- CP09 DOMINO

### DILLON - CULP

- DL01 LUGGAGE
- DL02 BUFF
- DL03 JAVA
- DL04 SAGE
- DL05 FIESTA
- DL06 LIPSTICK
- DL07 OCEAN
- DL08 STRATUS
- DL09 Black
- DL10 RECYCLED LEATHER

### EXPO - Momentum

- EX01 LATTE
- EX02 LEMON
- EX03 OASIS
- EX04 SPROUT
- EX05 LEAF
- EX06 ZEST
- EX07 SKY
- EX08 SPIRIT
- EX09 FESTIVE
- EX10 RASPBERRY
- EX11 VIOLA
- EX12 FOG
- EX13 TUXEDO

### FINE TUNE - CULP

- FT01 LUNA
- FT02 WHEAT
- FT03 COCOA
- FT04 HERB
- FT05 TANGELO
- FT06 RUBY
- FT07 INDIGO
- FT08 ASH
- FT09 ONYX

### FUSE - Momentum

- FS01 PEPPER
- FS02 CARMINE

- FS03 WALNUT
- FS04 CRESS
- FS05 LUNAR
- FS06 MOREL
- FS07 AZUREAN

### HABIT - Momentum

- HT01 KINDLE
- HT02 ASPEN
- HT03 DUNE
- HT04 SALT
- HT05 PIER
- HT06 BLUEPRINT
- HT07 TAILOR

### HIGH COTTON - CULP

- HC01 KHAKI
- HC02 COFFEE
- HC03 EVERGREEN
- HC04 CORDOVAN
- HC05 STEEL

### INSIGHT - Momentum

- IN04 EGGPLANT
- IN05 PORT
- IN06 BLOND
- IN07 FOSSIL
- IN08 MIDNIGHT
- IN10 PERIWINKLE
- IN11 REAL RED
- IN12 SUMMIT
- IN13 EBONY
- IN14 WASABI
- IN15 BARK
- IN16 SHALE
- IN17 PEPPER

### ORIGIN - Momentum

- OR01 ECO
- OR03 SAPPHIRE
- OR04 INDIGO
- OR05 SODALITE
- OR07 AMETHYST
- OR09 GARNET
- OR10 SYSTEM
- OR11 IRON
- OR12 STEEL
- OR13 JET
- OR14 AVALON
- OR15 MIKAN
- OR16 MALT
- OR17 TWINE
- OR18 CLAY
- OR19 GAIA
- OR20 EUREKA

### PERK - Momentum

- PE01 PATRIOT
- PE02 SESAME
- PE03 CEDAR
- PE04 DIJON
- PE05 PEWTER
- PE06 CABANA
- PE07 AUBURN
- PE08 CRIMSON
- PE09 WALNUT
- PE10 REGAL
- PE11 FLINT
- PE12 EBONY

## SYNTAX - Momentum

- SX01 CAMEL
- SX02 PLANT
- SX03 TURQUOISE
- SX04 FLARE
- SX05 SHALE
- SX06 PEWTER
- SX07 NECTAR
- SX08 TIGER EYE
- SX09 COCOA
- SX10 HUDSON
- SX11 STEEL
- SX12 ASPHALT
- SX13 CARMINE

### VINYL - Enduralex

- VN01 FOREST GREEN
- VN03 ALASKAN NIGHT
- VN04 ROYAL BLUE
- VN07 BORDEAUX
- VN08 ROYAL RED
- VN12 MOONBEAM
- VN15 CHESTNUT
- VN16 ST. THOMAS DUSK
- VN17 DOVE
- VN18 Black
- VN19 SNOW White
- VN21 OCEAN STORM
- VN25 CAPPUCCINO

### WINSLOW - CULP

- WI01 PUTTY
- WI02 FUDGE
- WI03 BLAZE
- WI04 DEEP RED
- WI05 BLUE CHIP
- WI06 MINERAL
- WI07 JET

## GRADE 02

### BEELINE VINYL - Momentum

- BL01 PORTOBELLO
- BL02 GEYSER
- BL03 CORK
- BL04 FORGE
- BL05 CANVAS
- BL06 FORGE
- BL07 NIMBUS
- BL08 OAT
- BL09 ORIOLE
- BL10 PARADE
- BL11 SPROUT
- BL12 SUNDANCE
- BL13 TIDAL
- BL14 WALNUT

### CANTER - Momentum

- CE01 ANCHO
- CE02 SAND
- CE03 SADDLE
- CE04 CHESTNUT
- CE05 EARTH
- CE06 SAFARI
- CE07 ALFALFA
- CE09 NIGHT
- CE10 MICA
- CE12 SABLE
- CE13 ONYX
- CE14 IRON

- CE15 NIMUS
- CE16 SUMAC
- CE17 STORM
- CE18 ADOBE
- CE19 BALLAD
- CE30 INK
- CE31 KIWI GREEN
- CE34 PINE
- CE37 QUARRY
- CE38 RED
- CE41 TANGO

### CANYON - Douglass

- CA02 CORDOVAN
- CA04 GREYSTONE
- CA05 MUDSLIDE
- CA06 NIGHTFALL
- CA07 NUGGET
- CA08 NUTMEG
- CA09 PUMPKIN
- CA10 RED ROCK
- CA11 OATMEAL
- CA12 DEVON
- CA13 PAVEMENT
- CA14 ATLANTIC
- CA15 RUSTIC

### COVER CLOTH

- CC01 PLATINUM
- CC04 CYAN
- CC03 SORREL
- CC14 TAIGA
- CC08 TAUPE
- CC05 ZEST
- CC15 FUCHSIA
- CC16 DELFT
- CC12 INDIGO
- CC13 GRAPHITE
- CC09 VESPER

### CURRENT - Momentum

- CU01 BIRCH
- CU02 PECAN
- CU03 MOSS
- CU04 ESPRESSO

### DOTCOM VINYL - Culp

- DM01 NUDE
- DM02 White
- DM03 FAWN
- DM04 COLA
- DM05 COIN
- DM06 Black
- DM07 GRAY
- DM08 PLATINUM
- DM09 BATIK
- DM10 RIVER
- DM11 LAWN
- DM12 HONEY
- DM13 CINNABAR
- DM14 CLAY

### ENDURANCE EPU

- EN01 BISQUE
- EN02 TOBACCO
- EN03 CASCADE
- EN04 DOVE
- EN05 SMITH
- EN06 AZURE
- EN07 SEED
- EN08 SPROUT

- EN09 BLUEBELL
- EN10 LICHEN
- EN11 COPPER
- EN12 LAPIS
- EN13 PAPRIKA
- EN14 PLUM
- EN15 JETTY
- EN16 CHERRY
- EN17 INK
- EN18 CLARET

### EPIC - Momentum

- EP01 PEARL
- EP02 KIWI
- EP03 AZURE
- EP04 SLICE

### FREE - Momentum

- FR01 PLATINUM
- FR02 EVENING
- FR03 PEARL
- FR04 ORBIT

### GROOVE EPU

- GR01 CALM
- GR02 BEACH
- GR03 ARCHIVE
- GR04 SURPLUS
- GR05 STONE
- GR06 INTENSE

### HATHAWAY VINYL - Culp

- HY01 APPLE
- HY02 AQUA
- HY03 CAFE
- HY04 DESERT
- HY05 ELECTRIC BLUE
- HY06 FIRE
- HY07 FOG
- HY08 GRAPE
- HY09 LEMON
- HY10 MAROON
- HY11 NAVY
- HY12 NICKEL
- HY13 OCEAN
- HY14 ONYX
- HY15 RASPBERRY
- HY16 ROOT BEER
- HY17 SMOKY
- HY18 TANGERINE
- HY19 White

### INFINITY - Momentum

- IY01 STUCCO
- IY02 DOVE
- IY03 PUMICE
- IY04 LEMONGRASS
- IY05 VANILLA
- IY06 LINKS
- IY07 SABLE
- IY08 BARLEY
- IY09 ATOLL
- IY10 MAIZE
- IY11 VINE
- IY12 RINSE
- IY13 ASTER
- IY14 PAPAYA
- IY15 BEYOND
- IY16 MACINTOSH
- IY17 BERRY

- IY18 HYACINTH
- IY19 ALUMINUM
- IY20 TYRIAN
- IY21 TERRAIN
- IY22 UMBER
- IY23 GULL
- IY24 PEWTER
- IY25 JAVA
- IY26 GRAPHITE

### KNACK - Momentum

- KN01 TEAK
- KN02 WAVE
- KN03 FRESCO
- KN04 FILAMENT

### LINEUP - Momentum

- LI01 SANDSTONE
- LI02 FERN
- LI03 BALTIC
- LI04 SPICE
- LI05 PEWTER

### MARATHON - Momentum

- MN01 POLLEN
- MN02 SPRITE
- MN03 OATS
- MN04 WREN
- MN05 OZ
- MN06 CURRY
- MN07 FLAX
- MN08 HERB
- MN09 CARVEL
- MN10 MARIGOLD
- MN11 FOLIAGE
- MN12 CYAN
- MN13 ALERT
- MN14 LANTERN
- MN15 VIVACIOUS
- MN16 FLOURITE
- MN17 RAIN
- MN18 TOILE
- MN19 CHILI
- MN20 DEEP
- MN21 CLAY
- MN22 SUNSET
- MN23 TINT
- MN24 VIOLET
- MN25 RIDGE
- MN26 ARBOR
- MN27 PINOT
- MN28 STORM
- MN29 NOIR
- MN30 CLOVE

### MILLENNIUM - Momentum

- MM01 CLEAN
- MM02 ELECTRIC
- MM03 CRISP
- MM04 SPARK
- MM05 ZINC
- MM06 NECTAR
- MM07 PERIDOT
- MM08 PLATEAU
- MM09 SAFARI
- MM10 COPPER
- MM11 PYRITE
- MM12 POOL
- MM13 VOYAGE
- MM14 AGLOW



MM15 CASCADE  
MM16 THRILL  
MM17 ORCHID  
MM18 COASTAL  
MM19 TANZANITE  
MM20 AMBER  
MM21 SAPPHIRE  
MM22 STEEL  
MM23 ANCHOR  
MM24 MONUMENT  
MM25 CAVERN  
MM26 CERISE  
MM27 MOCHA  
MM28 GEODE  
MM29 ONYX

**ODYSSEY - Momentum**

OY01 SKIM  
OY02 SMITH  
OY03 LINEN  
OY04 DIJON  
OY05 EMERALD  
OY06 CRAFT  
OY07 LIVELY  
OY08 INLET  
OY09 CRUISE  
OY10 KISS  
OY11 PRIMARY  
OY12 WESTERN  
OY13 AMP  
OY14 MARITIME  
OY15 INK  
OY16 SANGRIA  
OY17 CAPTAIN  
OY18 TINGE  
OY19 NETTLE  
OY20 OLIVER  
OY21 BREEZE  
OY22 CEDAR  
OY23 FOSSIL  
OY24 RUE  
OY25 ALLOY  
OY26 ROAST  
OY27 OPAQUE  
OY28 CARBON  
OY29 EGGPLANT  
OY30 IRIS

**PERSUASION - Douglass**

PR02 AUBERGINE  
PR04 BEET  
PR05 BISQUE  
PR06 BLUEBERRY  
PR07 BUTTERSOTCH  
PR08 CAFÉ  
PR09 CHIFFON  
PR10 CHINA RED  
PR11 CITRONELLA  
PR12 CURRY  
PR14 IRON  
PR15 JALAPENO  
PR16 MAIZE  
PR17 MATADOR  
PR18 MERIDIAN  
PR19 ONYX  
PR21 PUMPERNICKEL  
PR22 SAND  
PR24 MINK  
PR25 LIMON  
PR26 BADGER

PR27 OTTER  
PR28 TIGERLILY  
PR29 CONCRETE  
PR30 PEAPOD  
PR31 SKY DIVE  
PR32 CORTEZ

**PHOENIX VINYL - Douglass**

PH03 CAVIAR  
PH04 CHOCOLATE CHIP  
PH05 CHUTNEY  
PH06 DRIZZLE  
PH07 FOG  
PH09 OCHRE  
PH10 OUTBACK  
PH11 RUBY  
PH12 SNOWFLAKE  
PH13 WILLOW  
PH14 ROPE  
PH15 CHERRY  
PH16 CHESTNUT  
PH17 POSEIDON  
PH18 RHINO

**PROPENSITY - Moment**

PP01 CLOUD 9  
PP02 AMBER  
PP03 MUSHROOM

**SOLITAIRE**

SR01 DOVE  
SR02 AZTEC  
SR03 PUMICE  
SR04 SMITH  
SR05 TINSEL  
SR06 CYAN  
SR07 EMERALD  
SR08 DERBY  
SR09 PEEL  
SR10 VIOLET  
SR11 POPPY  
SR12 LAPIS  
SR13 GALENA  
SR14 JUBILEE  
SR15 CADET  
SR16 ONYX

**TRADITION - Momentum**

TN01 SOY  
TN02 GRAIN  
TN03 SUN  
TN04 SPROUT  
TN05 ASH  
TN06 MILLER  
TN07 LATTE  
TN08 FROND  
TN09 KELLY  
TN10 FLIRT  
TN11 SOAR  
TN12 TANGO  
TN13 ISLE  
TN14 PEEL  
TN15 CLASS  
TN16 JAZZ  
TN17 SPICED  
TN18 WASH  
TN19 THEATER  
TN20 STERLING  
TN21 MIST  
TN22 PLATED  
TN23 REGAL

TN24 WELD  
TN25 BRANCH  
TN26 DISTANT  
TN27 SLY  
TN28 MALBEC  
TN29 HIDDEN

**VIA - Momentum**

VI01 CORNSILK  
VI02 KHAKI  
VI03 SLATE  
VI04 FELDSPAR  
VI05 CAYENNE

**VIBE - Douglass**

VB01 ALCHEMY  
VB02 BALLPOINT  
VB04 BOMBAY BLUE  
VB06 CITYSCAPE  
VB07 CLEMENTINE  
VB08 CLOVER  
VB09 COCOA  
VB10 CORNSILK  
VB11 FLAX  
VB12 GRASSHOPPER  
VB13 INDIAN SUMMER  
VB14 IRISH LINEN  
VB15 MUSHROOM  
VB17 SUNSET  
VB18 HAMMOCK  
VB19 KERNEL  
VB20 YUKON  
VB21 SORBET  
VB22 GRAPEVINE  
VB23 LIME  
VB24 CORNERSTONE  
VB25 MERMAID  
VB26 ANCHOR

**WHISPER - Douglass**

WH01 SISAL  
WH02 KHAKI  
WH03 CAMEL  
WH04 White  
WH05 BONE  
WH06 CAPPUCCINO  
WH07 LUGGAGE  
WH08 GRAVEL  
WH09 ANTELOPE  
WH10 ELEPHANT  
WH11 CAVERN MOSS  
WH12 GREEN TEA  
WH13 FOREST  
WH14 LODEN  
WH15 ANTHRACITE  
WH16 PATINA  
WH17 CERULEAN  
WH18 NAVY  
WH19 CINNAMON  
WH20 SALSA  
WH21 BORDEAUX  
WH22 MERLOT  
WH23 CHARCOAL  
WH24 Black  
WH25 NIGHTSHADE  
WH26 Cashew  
WH27 Espresso  
WH28 Cognac  
WH29 Sangre

**GRADE 03**

**AMUSE - Momentum**

AM01 QUARTZ  
AM02 ADMIRAL  
AM03 ALLOY

**AVENUE - Momentum**

AV01 CARBON  
AV02 GARDEN  
AV03 SALSA

**BEEP - Momentum**

BP01 PONTOON  
BP02 FLAX  
BP03 FURNACE  
BP04 BRIDGE  
BP05 GREENLIGHT  
BP06 STEEL  
BP07 JET

**BOBBY - Momentum**

BY01 AQUA  
BY02 LEMON  
BY03 MOSS  
BY04 IRIS  
BY05 GLOW  
BY06 FUCHSIA  
BY07 ANCHOR

**CLANG - Momentum**

CL01 MALT  
CL02 FLINT  
CL03 CRESS  
CL04 CLOVE  
CL05 CLARET  
CL06 RAVEN

**COVER CLOTH - Momentum**

CC01 PLATINUM  
CC02 OAT  
CC03 SORREL  
CC04 CYAN  
CC05 ZEST  
CC06 SAVOR  
CC07 BOUQUET  
CC08 TAUPE  
CC09 VESPER  
CC10 FLAME  
CC11 HICKORY  
CC12 INDIGO  
CC13 GRAPHITE

**EON - Momentum**

EO01 ARENA  
EO02 GOLDMINE  
EO03 FIRE  
EO04 MINERAL  
EO05 GROVE  
EO06 COVE

EO07 HUMID  
EO08 ASCENSION  
EO09 OMEGA  
EO10 BLAZE  
EO11 MYSTERY  
EO12 TYPOGRAPHIC  
EO13 SPRING  
EO14 FRESHWATER  
EO15 BLAZE

**FAUX FELT - Momentum**

FF01 STONE  
FF02 PUMICE  
FF03 POOL  
FF04 BERRY  
FF05 PEBBLE  
FF06 QUAIL  
FF07 VIBRANT  
FF08 SPROUT  
FF09 LAGOON  
FF10 BARK  
FF11 CORAL  
FF12 FLANNEL  
FF13 CHARCOAL  
FF14 GRAPHITE

**FAUX MO - Momentum**

FM01 LIMON  
FM02 SHELL  
FM03 STONE  
FM04 WHEAT  
FM05 NICKEL  
FM06 POPPY  
FM07 BARK  
FM08 SKY  
FM09 OAT  
FM10 GRASS  
FM11 LAPIS  
FM12 SAPPHIRE  
FM13 CHARCOAL

**GRID - Momentum**

GD01 APPLE  
GD02 SUNBEAM  
GD03 CHROME  
GD04 KHAKI  
GD05 GLACIER  
GD06 INDIGO  
GD07 EMBER  
GD08 SCARLET  
GD09 ORCHID  
GD10 SURF  
GD11 FLINT  
GD12 JET

**KINNEY - Momentum**

KI01 FRAPPE  
KI02 VALENTINE  
KI03 COFFEE

KI04 MINERAL  
KI05 NECTAR  
KI06 STEEL

**LENS - Momentum**

LS01 GRAPHITE  
LS02 SAND  
LS03 Silver  
LS04 CRIMSON  
LS05 NAVY

**SKIP - Momentum**

SP01 ALLOY  
SP02 CAPTAIN  
SP03 CHALK  
SP04 CLEMENTINE  
SP05 COBALT  
SP06 DEEP  
SP07 ELM  
SP08 FLAX  
SP09 FLINT  
SP10 FUSCHIA  
SP11 KEYLIME  
SP12 MUSHROOM  
SP14 ONYX  
SP15 PEWTER  
SP17 RUBY  
SP18 SAFFRON  
SP19 SPARROW  
SP20 SPRITE  
SP21 STRAW  
SP22 TERRIAN  
SP23 VANILLA  
SP24 YACHT  
SP13 NICKEL  
SP16 POOL

**SOLACE - Momentum**

S001 IVORY  
S002 ALMOND  
S003 EARTH  
S004 CARMINE  
S005 PEAR  
S006 CELADON  
S007 AZUL  
S008 LAPIS  
S009 GILDED  
S010 BLAZE  
S011 NICKEL  
S012 EBONY

**STRUT - Momentum**

ST01 ASTRAL  
ST02 CHAI  
ST03 GALVANIZE  
ST04 COASTAL  
ST05 ISLE  
ST06 AREA  
ST07 MISSION

**Fabric Grade Program Shipping Information**

**Grade 01:** 2 weeks\*  
Grade 01. Our goal is to upholster and ship within 7 to 10 days from the receipt of your order.

**Grade 02 and 03:** 3 weeks\*  
Grade 02, and 03 fabric orders are shipped within 2 to 3 weeks from the receipt of fabric from cut yardage suppliers. This program is subject to fabric availability from the fabric mills.

**COM:** 2-3 weeks\*  
Upholstery will be scheduled for production and shipment within 2 to 3 weeks after receipt of sufficient quantities of Customer's Own Material (see COM policy for further details).

\*If you are ordering more than 12 units, please inquire as to availability and/or lead time for upholstery.

If you are selecting multiple fabric grades, your order will price at Grade 3.



# 5-DAY 5-Day Seating

Add personality to your space by selecting any plastic color or fabric/EPU from our 5-day collection. Seating in this collection ships within 5 days for orders of up to 50 chairs.

## Material Options



**Chestnut (CE04)**  
EPU



**Onyx (CE13)**  
EPU

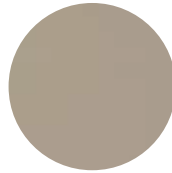

**Quarry (CE37)**  
EPU



**Jet (OR13)**  
Fabric

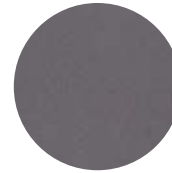

**Iron (OR11)**  
Fabric



**Twine (OR17)**  
Fabric



**Clay (OR18)**  
Fabric



**Indigo (OR04)**  
Fabric



**Gaia (OR19)**  
Fabric

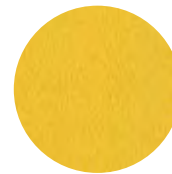

**Eureka (OR20)**  
Fabric

## Plastic Options



**Black (BL)**  
Arcozi • Reve  
Pique • Sassy • Vy

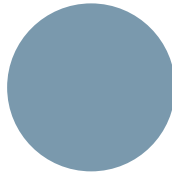

**Blue (BU)**  
Arcozi

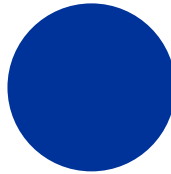

**Blue (BU)**  
Reve • Sassy • Vy

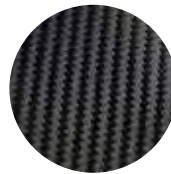

**Carbon Fiber (CF)**  
Reve

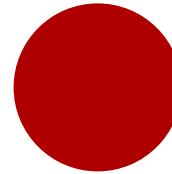

**Crimson (CI)**  
Reve • Vy



**Grass (GS)**  
Sassy

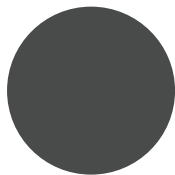

**Gray (GR)**  
Arcozi • Reve  
Sassy

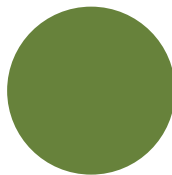

**Green (GN)**  
Arcozi

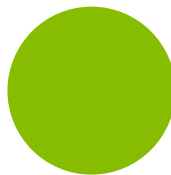

**Green (GN)**  
Reve • Vy

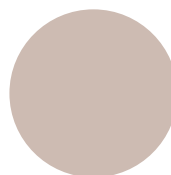

**Latte (LT)**  
Reve

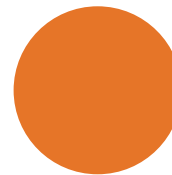

**Orange (OR)**  
Sassy

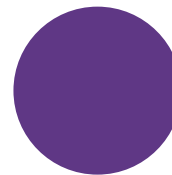

**Purple (PU)**  
Reve

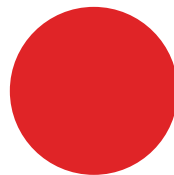

**Red (RD)**  
Arcozi • Sassy

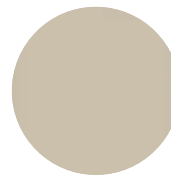

**Taupe (TP)**  
Arcozi

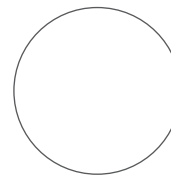

**White (WH)**  
Arcozi • Reve  
Sassy • Vy

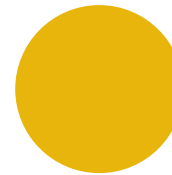

**Yellow (YE)**  
Sassy

## Safco COM Policy

Contact Customer Care at 1-888-971-6225 for inquiries regarding COM and/or to submit 12" w x 12" h textile samples, including repeat information. The COM textile must be approved prior to order fulfillment. Contact Customer Care for logistical details.

Submitting COM Textiles

Reference PO # on all textile rolls.

- For non-directional, plain, solid color or non-patterned fabrics, please follow COM yardage requirements as specified under each individual model number in our selection guide.
- For all textiles, please attach a sample of the COM textile to our COM form (see below). Include all information and return to Safco Products as directed by Customer Care for testing and approval. Please include mill specifications regarding fabric.
- Customer Care will notify customer of COM approval.

Upon COM approval, send purchase order to Safco Products Customer Care Department.

1. Purchase orders must include clearly defined COM information including textile name, color, description and textile company name.
2. Orders requesting COM will be placed on "Manufacturing Schedule hold" until the COM textile is received.
3. Upon receipt of COM textile, the order will be released into production and shipped within 2 to 3 weeks.

All COM textiles received at Safco Products must include the following information:

### Customer's Own Material Form (Please Photocopy)

Dealer/Customer \_\_\_\_\_  
 Contact Name \_\_\_\_\_  
 Address \_\_\_\_\_  
 City/State/Zip \_\_\_\_\_  
 Phone Number \_\_\_\_\_  
 E-mail Address \_\_\_\_\_  
 Fabric Source (Mill) \_\_\_\_\_  
 Mill Phone Number \_\_\_\_\_  
 Fabric Name/Number \_\_\_\_\_  
 Fabric Color \_\_\_\_\_  
 Fabric Content \_\_\_\_\_  
 Pattern Repeat \_\_\_\_\_  
 Total Yardage Shipped \_\_\_\_\_

1. Customer's name, address and phone number
2. Purchase order number
3. Any special instructions for application
4. Any flaws in COM must be clearly indicated

COM Directional Fabrics

- Safco may consider some COM fabrics directional that the fabric supplier does not due to the upholstery process Safco uses.
- Application of COM fabric will be upholstered as shown on the COM supplier memo sample or website. Please contact Safco Customer Care for a custom quote if a different pattern/application is desired.
- Arc-Com/CF Stinson/Maharam/Momentum/Ultrafabrics Alliance fabrics will be upholstered as shown on the supplier memo sample or website. Please contact Safco Customer Care for a custom quote if a different pattern/application is desired.

Safco Products is not responsible for yardage submitted to us beyond the required amount. Excess COM textile will be held in-house for 60 days and will be discarded after that time period. If a customer requires the COM excess yardage returned, they must contact Customer Care at Safco Products to make arrangements. The customer will be responsible for delivery charges.

Safco Products warranties do not apply to Customer's Own Material and Safco Products assumes no responsibility for defects, wear or performance of the Customer's Own Material.

Please send all COM textile to:

Safco Products Company  
 2700 Barrett Lakes Boulevard, Suite 700  
 Kennesaw, GA 30144-6896

Date \_\_\_\_\_

Purchase Order Number \_\_\_\_\_

Model Number \_\_\_\_\_

Quantity \_\_\_\_\_

Please check one:

\_\_\_\_ This form is to request fabric testing

\_\_\_\_ This form accompanies customer fabric for the referenced PO number.

Application

Is there a desired top and bottom to the fabric application? Yes \_\_\_\_ No \_\_\_\_

Is the fabric a stripe or two-color plaid? Yes \_\_\_\_ No \_\_\_\_

If Yes Apply: Horizontal \_\_\_\_ Vertical \_\_\_\_

Circle and check box for correct application:

Horizontal



Vertical



Textile Sample: Attach sample textile cutting here with desired face and direction displayed.

top

bottom





# Seating Series

Safco® Products marketing materials are designed to be used as sales tools for our Dealer network.

Model #	Description	Fabric Grades/Model #	List Price Ea.	List Carton Price	Quantity Per Carton
<b>Arcozi Series Stack Seating</b> <small>NEW</small>					
<b>ASC1P</b>	Arcozi Four-Leg Stacking Chair - Plastic	ASC1P	249.00	498.00	2
<b>ASC1U</b>	Arcozi Four-Leg Stacking Chair - Upholstered	ASC1U	329.00	658.00	2
<b>Seat Upholstery</b>					
Plastic Seat			Upcharge		
Grade 1	01	N/C	N/C		
Grade 2	02	45.00	90.00		
Grade 3	03	136.00	272.00		
COM Yardage	COM	45.00	90.00		
<b>Other Options</b>					
Seat Plastic Color			Upcharge		
Back Plastic Color			N/C		
Base Color			N/C		
<b>ASC2P</b>	Arcozi Sled Base Stacking Chair - Plastic	ASC2P	259.00	518.00	2
<b>ASC2U</b>	Arcozi Sled Base Stacking Chair - Upholstered	ASC2U	339.00	678.00	2
<b>Seat Upholstery</b>					
Plastic Seat			Upcharge		
Grade 1	01	N/C	N/C		
Grade 2	02	45.00	90.00		
Grade 3	03	136.00	272.00		
COM Yardage	COM	45.00	90.00		
<b>Other Options</b>					
Seat Plastic Color			Upcharge		
Back Plastic Color			N/C		
Base Color			N/C		
<b>ASC3P</b>	Arcozi Guest Chair - Plastic	ASC3P	329.00	329.00	1
<b>ASC3U</b>	Arcozi Guest Chair - Upholstered	ASC3U	409.00	409.00	1
<b>Seat Upholstery</b>					
Plastic Seat			Upcharge		
Grade 1	01	N/C	N/C		
Grade 2	02	45.00	45.00		
Grade 3	03	136.00	136.00		
COM Yardage	COM	45.00	45.00		
<b>Other Options</b>					
Seat Plastic Color			Upcharge		
Back Plastic Color			N/C		
Base Color			N/C		

PLEASE CHOOSE OPTIONS FROM BELOW:

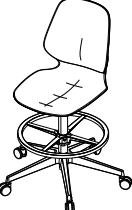
Model	Seat Option	Back Color		Seat Color		Upholstered Fabric Grade	Upholstered Fabric	Frame Color
ASC1 ASC2 ASC3	Plastic-P* Upholstered-U	BL-Black BU-Blue GN-Green GR-Gray	RD-Red TP-Taupe WH-White	BL-Black BU-Blue GN-Green GR-Gray	RD-Red TP-Taupe WH-White	01 02 03 COM	See pgs. 52-53 for Grades 01-03	SL-Silver WH-White
*For Plastic Seat, leave blank								
<b>Example:</b> ASC2+	<u>U</u> +	<u>B</u> <u>L</u> +		<u>B</u> <u>U</u> +		<u>0</u> <u>1</u> +	<u>O</u> <u>R</u> <u>1</u> <u>8</u> +	<u>S</u> <u>L</u>

Model #	Description	Fabric Grades/Model #	List Price Ea.	List Carton Price	Quantity Per Carton
<b>Arcozi Series Task Seating</b> <span style="border: 1px solid black; border-radius: 50%; padding: 2px;">NEW</span>					
	<b>ASC5P</b> Arcozi Task Chair - Plastic	ASC5P	429.00	429.00	1
	<b>ASC5U</b> Arcozi Task Chair - Upholstered	ASC5U	509.00	509.00	1
	<b>Seat Upholstery</b> Upcharge				
	Plastic Seat		N/C	N/C	
	Grade 1	01	N/C	N/C	
	Grade 2	02	45.00	45.00	
	Grade 3	03	136.00	136.00	
	COM Yardage	COM	45.00	45.00	
	<b>Other Options</b> Upcharge				
	Seat Plastic Color		N/C	N/C	
	Back Plastic Color		N/C	N/C	
	Add Arms		75.00	75.00	
	Standard Caster		N/C	N/C	
	Hard Floor Caster		N/C	N/C	
	Hard Floor Premium		65.00	65.00	
	<b>ASC6P</b> Arcozi Extended-Height Chair - Plastic	ASC6P	519.00	519.00	1
	<b>ASC6U</b> Arcozi Extended-Height Chair - Upholstered	ASC6U	599.00	599.00	1
	<b>Seat Upholstery</b> Upcharge				
	Plastic Seat		N/C	N/C	
	Grade 1	01	N/C	N/C	
	Grade 2	02	45.00	45.00	
	Grade 3	03	136.00	136.00	
	COM Yardage	COM	45.00	45.00	
	<b>Other Options</b> Upcharge				
	Seat Plastic Color		N/C	N/C	
	Back Plastic Color		N/C	N/C	
	Add Arms		75.00	75.00	
	Standard Caster		N/C	N/C	
	Hard Floor Caster		N/C	N/C	
	Hard Floor Premium		65.00	65.00	

PLEASE CHOOSE OPTIONS FROM BELOW:

Model	Seat Option	Back Color		Seat Color		Upholstered Fabric Grade	Upholstered Fabric	Arms	Casters
ASC5 ASC6	Plastic-P* Upholstered-U	BL-Black BU-Blue GN-Green GR-Gray	RD-Red TP-Taupe WH-White	BL-Black BU-Blue GN-Green GR-Gray	RD-Red TP-Taupe WH-White	01 02 03 COM	See pgs. 52-53 for Grades 01-03	AL-Armless WA-With Arms	HF-Hard Floor HFP-Hard Floor Premium ST-Standard Caster
*For Plastic Seat, leave blank									
<b>Example:</b> ASC5+	<u>U</u> +	<u>B</u> <u>L</u> +		<u>B</u> <u>U</u> +		<u>0</u> <u>1</u> +	<u>O</u> <u>R</u> <u>1</u> <u>8</u> +	<u>A</u> <u>L</u> +	<u>H</u> <u>F</u>

# Seating Series

Safco® Products marketing materials are designed to be used as sales tools for our Dealer network.

Model #	Description	Fabric Grades/Model #	List Price Ea.	List Carton Price	Quantity Per Carton
<b>Arcozi Series Bistro-Height Seating</b> <span style="border: 1px solid black; border-radius: 50%; padding: 2px;">NEW</span>					
<b>ASC4P</b>	Arcozi Bistro-Height Chair - Plastic	ASC4P	419.00	838.00	2
<b>ASC4U</b>	Arcozi Bistro-Height Chair - Upholstered	ASC4U	499.00	998.00	2

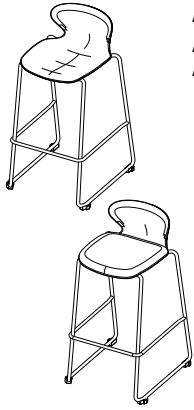

**Seat Upholstery**

			Upcharge
Plastic Seat			N/C
Grade 1	01		N/C
Grade 2	02	45.00	90.00
Grade 3	03	136.00	272.00
COM Yardage	COM	45.00	90.00

**Other Options**

		Upcharge
Seat Plastic Color	N/C	N/C
Base Color	N/C	N/C

PLEASE CHOOSE OPTIONS FROM BELOW:

Model	Seat Option	Seat Color	Upholstered Fabric Grade	Upholstered Fabric	Frame Color
ASC4	Plastic-P* Upholstered-U	BL-Black RD-Red BU-Blue TP-Taupe GN-Green WH-White GR-Gray	01 02 03 COM	See pgs. 52-53 for Grades 01-03	SL-Silver WH-White
			*For Plastic Seat, leave blank		
<b>Example:</b> ASC4+	U +	B U +	0 1 +	O R 1 8 +	S L



**Arcozi Series Classroom Seating** NEW

<b>ASC7P</b>	Arcozi Classroom Chair - Plastic	ASC7P	679.00	679.00	1
<b>ASC7U</b>	Arcozi Classroom Chair - Upholstered	ASC7U	759.00	759.00	1

**Seat Upholstery**

			Upcharge
Plastic Seat			N/C
Grade 1	01		N/C
Grade 2	02	45.00	45.00
Grade 3	03	136.00	136.00
COM Yardage	COM	45.00	45.00

**Other Options**

		Upcharge
Seat Plastic Color	N/C	N/C
Back Plastic Color	N/C	N/C
Base Color	N/C	N/C
Universal Tablet Arm		Subtract \$75 from price for No Tablet

PLEASE CHOOSE OPTIONS FROM BELOW:

Model	Seat Option	Back Color	Seat Color	Upholstered Fabric Grade	Upholstered Fabric	Frame Color	Tablet Choice	Tablet Color
ASC7	Plastic-P* Upholstered-U	BL-Black RD-Red BU-Blue TP-Taupe GN-Green WH-White GR-Gray	BL-Black RD-Red BU-Blue TP-Taupe GN-Green WH-White GR-Gray	01 02 03 COM	See pgs. 52-53 for Grades 01-03	SL-Silver WH-White	WT-With Tablet NT-No Tablet	BL-Black WH-White
			*For Plastic Seat, leave blank					
<b>Example:</b> ASC7+	U +	B L +	B U +	0 1 +	O R 1 8 +	S L +	W T +	B L

Model #	Description	Fabric Grades/Model #	List Price Ea.	List Carton Price	Quantity Per Carton	Actual Weight	S-Parcel Billable Weight	Carton Cube	Freight Class
---------	-------------	-----------------------	----------------	-------------------	---------------------	---------------	--------------------------	-------------	---------------



**Revere™ Guest Chair**  
**4022** Revere™ Guest Chair, All Plastic Back & Seat  
 Seat Height: 18" H (Sled Base), 18½" H (Straight Leg)  
 Seat Size: 18" W x 17" D  
 Back Size: 18" W x 13¾" H  
 Overall Size: 19¼" W x 23½" D x 33¾" H (Sled Base)  
 19" W x 24¼" D x 33¾" H (Straight Leg)

**Revere™ Guest Chair, Upholstered Seat**

Style (Back Selection)	Upcharge	
Plastic Back	N/C	N/C
Carbon (Fiber)	51.00	102.00
Wood	51.00	102.00
Mesh	43.00	86.00

**Seat Styles**

Plastic Seat	N/C	N/C
Upholstered	60.00	120.00
Carbon (Fiber)	51.00	102.00
Wood	51.00	102.00
Mesh	90.00	180.00

**Base Styles**

Sled Base	N/C	N/C
Casters	87.00	174.00
Glides	71.00	142.00

Grade 1	01	N/C	N/C
Grade 2	02	44.00	88.00
Grade 3	03	75.00	150.00
COM Yardage: 0.75 yds.	COM	44.00	88.00

Only Revere™ Plastic Back & Seat meets CAL 133 Standards \$50.00 up-charge required per chair for upholstered styles (not wood or mesh).

PLEASE CHOOSE OPTIONS FROM BELOW:

Model	Base Style	Back Type	Back Style	Back Color	Seat Style	Seat Color	Frame Color	Fabric Grade	Fabric
4022	SB-Sled Base WC-Straight Leg w/Casters WG-Straight Leg w/Glides	RD-Round SQ-Square	PB-Plastic MB-Mesh CB-Carbon Fiber WB-Wood	Plastic BL-Black BU-Blue GN-Green LT-Latte CI-Crimson GR-Gray WH-White PU-Purple CF-Carbon Fiber Mesh Back BL-Black LA-Lapis LT-Latte CI-Crimson Plastic Wood CY-Cherry MH-Mahogany NA-Natural	PS-Plastic US-Upholstered MS-Mesh CS-Carbon Fiber WS-Wood	Plastic BL-Black BU-Blue GN-Green LT-Latte CI-Crimson GR-Gray WH-White PU-Purple CF-Carbon Fiber Mesh Seat BL-Black Plastic Wood CY-Cherry MH-Mahogany NA-Natural	CR-Chrome SL-Silver	01 02 03 COM	See pgs. 52-53 for Grades 01 - 03 fabric swatches
<b>Example:</b> 4 0 2 2 +	S B +	R D +	P B +	B L +	U S +	B L +	S L +	0 2 +	E P 0 3

When all Plastic, fill in "00 & 0000" for Fabric Grade & Fabric.



**6804** Revere™ Sled Base Guest Chair, Plastic Back & Seat  
 Seat Height: 18"  
 Seat Size: 18" W x 17" D  
 Back Size: 18" W x 13¾" H  
 Overall Size: 19¼" W x 23½" D x 33¾" H  
 Plastic: Black-BL, Green-GN, Blue-BU, Latte-LT  
 \* Only available to order by Carton.

6804BL	257.00	514.00	2	25	118	11.31	250
6804GN							
6804BU							
6804LT							



**6805** Revere™ Straight Leg Guest Chair, All Plastic Back & Seat  
 Seat Height: 18½"  
 Seat Size: 18" W x 17" D  
 Back Size: 18" W x 13¾" H  
 Overall Size: 19" W x 24¼" D x 33¾" H  
 Plastic: Black-BL, Green-GN, Blue-BU, Latte-LT  
 \* Only available to order by Carton.

6805BL	331.00	662.00	2	26	118	11.32	250
6805GN							
6805BU							
6805LT							

# Seating Series

Safco® Products marketing materials are designed to be used as sales tools for our Dealer network.

Model #	Description	Fabric Grades/ Model #	List Price Ea.	List Carton Price	Quantity Per Carton	Actual Weight	S-Parcel Billable Weight	Carton Cube	Freight Class
<b>Reve™ Series Sled Base with Tablet Arm</b>									
<b>4039</b>	Reve™ Sled Base - Tablet Arm, All Plastic Back & Seat Seat Height: 18" Seat Size: 18½"W x 17"D Back Size: 18"W x 13¾"H Overall Size: 24"W x 30½"D x 33¼"H Reve™ Sled Base Plastic Back Upholstered Seat	Plastic*	428.00	428.00	1	26	143	13.67	250
Upcharge									
<b>Back Style</b>									
	Plastic Back		N/C	N/C					
	Carbon (Fiber)		51.00	51.00					
	Wood		51.00	51.00					
	Mesh		43.00	43.00					
<b>Seat Styles</b>									
	Plastic Seat		N/C	N/C					
	Upholstered		60.00	60.00					
	Carbon (Fiber)		51.00	51.00					
	Wood		51.00	51.00					
	Mesh		91.00	91.00					
<b>Tablet Arm</b>									
	Tablet Arm Right Hand		N/C	N/C					
	Tablet Arm Left Hand		N/C	N/C					
	Book Rack		56.00	56.00					
	Grade 1	01	N/C	N/C					
	Grade 2	02	44.00	44.00					
	Grade 3	03	75.00	75.00					
	COM Yardage: 0.75 yds.	COM	44.00	44.00					
Only Reve™ Plastic Back & Seat meets CAL 133 Standards (not wood or mesh).									



PLEASE CHOOSE OPTIONS FROM BELOW:

Model	Back Type	Back Style	Back Color	Seat Style	Seat Color	Frame Color	Fabric Grade	Fabric	Tablet Arms	Book Rack	
4039	RD-Round SQ-Square	PB-Plastic MB-Mesh CB-Carbon Fiber WB-Wood	Plastic BL-Black BU-Blue GN-Green LT-Latte CI-Crimson GR-Gray WH-White PU-Purple CF-Carbon Fiber Mesh Back BL-Black LA-Lapis LT-Latte CI-Crimson Plastic Wood CY-Cherry MH-Mahogany NA-Natural	PS-Plastic US-Upholstered MS-Mesh CS-Carbon Fiber WS-Wood	Plastic BL-Black BU-Blue GS-Green LT-Latte CI-Crimson GR-Gray WH-White PU-Purple CF-Carbon Fiber Mesh Seat BL-Black Plastic Wood CY-Cherry MH-Mahogany NA-Natural	CR-Chrome SL-Silver	01 02 03 COM	See pgs. 52-53 for Grades 01 - 03 fabric swatches	RT-Right Hand Tablet Arm LT-Left Hand Tablet Arm	BR-Book Rack	
<b>Example:</b>	<b>4 0 3 9 +</b>	<b>R D +</b>	<b>P B +</b>	<b>L A +</b>	<b>P S +</b>	<b>L A +</b>	<b>C R +</b>	<b>0 0 +</b>	<b>0 0 0 0 +</b>	<b>R T +</b>	<b>B R</b>

\*When all Plastic fill in "00 & 0000" for Fabric Grade & Fabric.

\*See page 51 for Chair Features and Chair Functions.



Model #	Description	Fabric Grades/Model #	List Price Ea.	List Carton Price	Quantity Per Carton	Actual Weight	S-Parcel Billable Weight	Carton Cube	Freight Class
<b>4021</b>	<b>Reve™ Series Task Chair</b> <b>1 5 6 11 12 *</b> Reve™ Task Chair, All Plastic Back & Seat Seat Height: 18" - 22½" Seat Size: 18"W x 17"D Back Size: 18"W x 13¾"H Overall Size: 24"W x 24"D x 35½" - 39"H	Plastic*	660.00	660.00	1	26	98	9.39	250
<b>Style (Back Selection)</b>		<b>Upcharge</b>							
Plastic Back		N/C N/C							
Carbon (Fiber)		51.00 51.00							
Wood		51.00 51.00							
Mesh		43.00 43.00							
<b>Seat Styles</b>									
Plastic Seat		N/C N/C							
Upholstered		60.00 60.00							
Carbon (Fiber)		51.00 51.00							
Wood		51.00 51.00							
Mesh		91.00 91.00							
<b>Arms</b>									
Armless		N/C N/C							
Arms		45.00 45.00							
<b>Height Options</b>									
Standard Seat Height: 18" - 22½"H		N/C N/C							
Extended Seat Height: 25" - 35"H		54.00 54.00							
Grade 1		01 N/C N/C							
Grade 2		02 44.00 44.00							
Grade 3		03 75.00 75.00							
COM Yardage: 0.75 yds.		COM 44.00 44.00							
Only Reve™ Plastic Back & Seat meets CAL 133 Standards (not wood or mesh).									



PLEASE CHOOSE OPTIONS FROM BELOW:

Model	Back Type	Back Style	Back Color	Seat Style	Seat Color	Frame Color	Fabric Grade	Fabric	Arm Options	Height Options
4021	RD-Round SQ-Square	PB-Plastic MB-Mesh CB-Carbon Fiber WB-Wood	<b>Plastic</b> BL-Black BU-Blue GN-Green LT-Latte CI-Crimson GR-Gray WH-White PU-Purple <b>CF-Carbon Fiber</b> <b>Mesh Back</b> BL-Black LA-Lapis LT-Latte CI-Crimson <b>Plastic Wood</b> CY-Cherry MH-Mahogany NA-Natural	PS-Plastic US-Upholstered MS-Mesh CS-Carbon Fiber WS-Wood	<b>Plastic</b> BL-Black BU-Blue GN-Green LT-Latte CI-Crimson GR-Gray WH-White PU-Purple <b>CF-Carbon Fiber</b> <b>Mesh Seat</b> BL-Black <b>Plastic Wood</b> CY-Cherry MH-Mahogany NA-Natural	CR-Chrome SL-Silver	01 02 03 COM	See pgs. 52-53 for Grades 01 - 03 fabric swatches	AL-Armless WA-Arms	ST-Standard EX-Extended
<b>Example:</b>	<u>4</u> <u>0</u> <u>2</u> <u>1</u> +	<u>R</u> <u>D</u> +	<u>P</u> <u>B</u> +	<u>L</u> <u>A</u> +	<u>U</u> <u>S</u> +	<u>C</u> <u>R</u> +	<u>0</u> <u>2</u> +	<u>E</u> <u>P</u> <u>0</u> <u>3</u> +	<u>W</u> <u>A</u> +	<u>S</u> <u>T</u>

\*When all Plastic fill in "00 & 0000" for Fabric Grade & Fabric.



<b>6803</b>	<b>Reve™ Task Chair, Plastic Back</b> <b>1 5 6 11 12 *</b> Black Upholstered Seat Seat Height: 18" - 22½" Seat Size: 18"W x 17"D Back Size: 18"W x 13¾"H Overall Size: 24"W x 24"D x 35½" - 39"H <b>Plastic:</b> Black-BL, Latte-LT	6803BL 6803LT	769.00	769.00	1	26	81	7.71	250
<b>6807</b>	<b>Reve™ Task Chair, Plastic Square Back</b> <b>1 5 6 11 12 *</b> Black Upholstered Seat Seat Height: 18" - 22½" Seat Size: 18"W x 17"D Back Size: 18"W x 13¾"H Overall Size: 24"W x 24"D x 35½" - 39"H <b>Plastic:</b> Black-BL, Latte-LT	6807BL 6807LT	769.00	769.00	1	35	98	9.19	250
<b>6820BL</b>	<b>Reve™ All Mesh Extended-Height-Chair</b> Seat Height: 25" - 35" Seat Size: 18"W x 17½"D Back Size: 18¾"W x 15"H Overall Size: 26"W x 26"D x 39" - 49"H <b>Mesh:</b> Black-BL	6820BL	835.00	835.00	1	42	102	9.56	150





\*See page 51 for Chair Features and Chair Functions.

# Seating Series

Safco® Products marketing materials are designed to be used as sales tools for our Dealer network.



Model #	Description	Fabric Grades/ Model #	List Price Ea.	List Carton Price	Quantity Per Carton	Actual Weight	S-Parcel Billable Weight	Carton Cube	Freight Class
<b>Reve™ Series Bistro-Height Seating</b>									
	<b>4017</b> Reve™ Plastic Seat Bistro-Height, All Plastic Seat Height: 31" Seat Size: 18½"W x 17"D Back Size: 18"W x 13¾"H Overall Size: 19¾"W x 23½"D x 47½"H	*All Plastic	482.00	482.00	1	39	174	16.67	250
	Reve™ Bistro-Height Plastic Back, Upholstered Seat	Upcharge							
<b>Back Style</b>									
Plastic Back			N/C	N/C					
Carbon (Fiber)			51.00	51.00					
Wood			51.00	51.00					
Mesh			43.00	43.00					
<b>Seat Styles</b>									
Plastic Seat			N/C	N/C					
Upholstered			60.00	60.00					
Carbon (Fiber)			51.00	51.00					
Wood			51.00	51.00					
Mesh			91.00	91.00					
Grade 1		01	N/C	N/C					
Grade 2		02	44.00	44.00					
Grade 3		03	75.00	75.00					
COM Yardage: 0.75 yds.		COM	44.00	44.00					

	<b>6815</b> Reve™ Counter-Height Sled Base Chair, All Plastic Seat Height: 25" Seat Size: 18½"W x 17"D Back Size: 18"W x 13¾"H Overall Size: 19¾"W x 23½"D x 42½"H	*All Plastic	462.00	462.00	1	20	108	10.33	300
	Reve™ Bistro-Height Plastic Back, Upholstered Seat	Upcharge							
<b>Back Style</b>									
Plastic Back			N/C	N/C					
Carbon (Fiber)			51.00	51.00					
Wood			51.00	51.00					
Mesh			43.00	43.00					
<b>Seat Styles</b>									
Plastic Seat			N/C	N/C					
Upholstered			60.00	60.00					
Carbon (Fiber)			51.00	51.00					
Wood			51.00	51.00					
Mesh			91.00	91.00					
Grade 1		01	N/C	N/C					
Grade 2		02	44.00	44.00					
Grade 3		03	75.00	75.00					
COM Yardage: 0.75 yds.		COM	44.00	44.00					

PLEASE CHOOSE OPTIONS FROM BELOW:





Model	Back Type	Back Style	Back Color	Seat Style	Seat Color	Frame Color	Fabric Grade	Fabric
4017	RD-Round SQ-Square	PB-Plastic MB-Mesh CB-Carbon Fiber WB-Wood	<b>Plastic</b> BL-Black BU-Blue GN-Green LT-Latte CI-Crimson GR-Gray WH-White PU-Purple <b>CF-Carbon Fiber</b> <b>Mesh Back</b> BL-Black LA-Lapis LT-Latte CI-Crimson <b>Plastic Wood</b> CY-Cherry MH-Mahogany NA-Natural	PS-Plastic US-Upholstered MS-Mesh CS-Carbon Fiber WB-Wood	<b>Plastic</b> BL-Black BU-Blue GN-Green LT-Latte CI-Crimson GR-Gray WH-White PU-Purple <b>CF-Carbon Fiber</b> <b>Mesh Seat</b> BL-Black <b>Plastic Wood</b> CY-Cherry MH-Mahogany NA-Natural	CR-Chrome SL-Silver	01 02 03 COM	See pgs. 52-53 for Grades 01 - 03 fabric swatches
<b>Example:</b>	<u>4</u> <u>0</u> <u>1</u> <u>7</u> +	<u>R</u> <u>D</u> +	<u>W</u> <u>B</u> +	<u>C</u> <u>Y</u> +	<u>U</u> <u>S</u> +	<u>C</u> <u>R</u> +	<u>0</u> <u>2</u> +	<u>V</u> <u>I</u> <u>0</u> <u>1</u>

\*When all Plastic fill in "00 & 0000" for Fabric Grade & Fabric.

	<b>6806</b> Reve™ Bistro-Height Sled Base Chair, All Plastic Seat Height: 31" Seat Size: 18½"W x 17"D Back Size: 18"W x 13¾"H Overall Size: 19¾"W x 23½"D x 47½"H <b>Plastic:</b> Black-BL, Green-GN, Blue-BU, Latte-LT	6806BL 6806GN 6806BU 6806LT	482.00	482.00	1	21	170	16.25	300
	<b>6815BL</b> Reve™ Counter-Height Sled Base Chair, All Plastic Seat Height: 25" Seat Size: 18½"W x 17"D Back Size: 18"W x 13¾"H Overall Size: 19¾"W x 23½"D x 42½"H <b>Plastic:</b> Black-BL Only Reve™ Plastic Back & Seat meets CAL 133 Standards (not wood or mesh).	6815BL	462.00	462.00	1	20	108	10.33	300

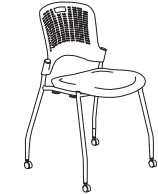
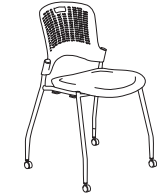
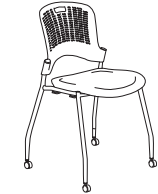

\*See page 51 for Chair Features and Chair Functions.

Office Suites  
Seating  
Tables & Desks  
Meeting Essentials  
Personal Organization  
Ergonomics  
High Density Storage  
Storage & Filing  
Facilities  
Technology Furniture  
Art & Engineering  
K-12 Education  
SAFE Collection Addendum

Model #	Description	Fabric Grades/ Model #	List Price Ea.	List Carton Price	Quantity Per Carton	Actual Weight	S-Parcel Billable Weight	Carton Cube	Freight Class	
<b>Sassy® Series Stack Seating</b>										
<b>4183 Series</b>										
	<b>4183PALG</b>	Sassy® Stack, Armless with Glides, Plastic (PALG)	Plastic	332.00	664.00	2	36	129	12.31	250
		Sassy® Stack, Armless with Glides, Upholstered Seat (UALG)	01	379.00	758.00	2	36	145	12.31	250
		Seat Height: 18¼"	02	399.00	798.00					
		Seat Size: 18"W x 18"D	03	422.00	844.00					
		Back Size: 16½"W x 12¾"H	COM	399.00	798.00					
		Overall Size: 25½"W x 22¾"D x 34¼"H								
COM Yardage: 0.75 yds.										
* Only available to order by Carton.										
	<b>4183PALC</b>	Sassy® Stack, Armless with Casters, Plastic (PALC)	Plastic	356.00	712.00	2	36	145	12.31	250
		Sassy® Stack, Armless with Casters, Upholstered Seat (UALC)	01	400.00	800.00					
		Seat Height: 18¼"	02	422.00	844.00					
		Seat Size: 18"W x 18"D	03	445.00	890.00					
		Back Size: 16½"W x 12¾"H	COM	422.00	844.00					
		Overall Size: 25½"W x 22¾"D x 34¼"H								
COM Yardage: 0.75 yds.										
* Only available to order by Carton.										
	<b>4183PWAG</b>	Sassy® Stack, with Arms & Glides, Plastic (PWAG)	Plastic	379.00	758.00	2	36	145	12.31	250
		Sassy® Stack, with Arms & Glides, Upholstered Seat (UWAG)	01	422.00	844.00					
		Seat Height: 18¼"	02	445.00	890.00					
		Seat Size: 18"W x 18"D	03	467.00	934.00					
		Back Size: 16½"W x 12¾"H	COM	445.00	890.00					
		Overall Size: 25½"W x 22¾"D x 34¼"H								
COM Yardage: 0.75 yds.										
* Only available to order by Carton.										
	<b>4183PWAC</b>	Sassy® Stack, with Arms & Casters, Plastic (PWAC)	Plastic	400.00	800.00	2	36	145	12.31	250
		Sassy® Stack, with Arms & Casters, Upholstered Seat (UWAC)	01	445.00	890.00					
		Seat Height: 18¼"	02	467.00	934.00					
		Seat Size: 18"W x 18"D	03	489.00	978.00					
		Back Size: 16½"W x 12¾"H	COM	467.00	934.00					
		Overall Size: 25½"W x 22¾"D x 34¼"H								
COM Yardage: 0.75 yds.										
* Only available to order by Carton.										
All Sassy Chairs meet CAL 133 Standards, \$50.00 up-charge required per chair for upholstered styles (not available in vinyl).										

PLEASE CHOOSE OPTIONS FROM BELOW:

Model	Style	Plastic Back	Plastic Seat	Fabric Grade	Fabric	Casters
4183	PALG-Plastic, Armless with Glides UALG-Upholstered, Armless with Glides PALC-Plastic, Armless with Casters UALC-Upholstered, Armless with Casters PWAG-Plastic, with Arms & Glides UWAG-Upholstered, with Arms & Glides PWAC-Plastic, with Arms & Casters UWAC-Upholstered, with Arms & Casters	BL-Black BU-Blue GR-Gray GS-Grass OR-Orange RD-Red WH-White YE-Yellow	BL-Black BU-Blue GR-Gray GS-Grass OR-Orange RD-Red WH-White YE-Yellow	01 02 03 COM	See pgs. 52-53 for Grades 01 - 03 fabric swatches	4083 Soft Casters 0000 Standard Carpet Casters
Example:						
4 1 8 3 +	U W A C +	B L +	B L +	0 2 +	F R 0 3 +	4 0 8 3 (Enter 0000 for Standard Carpet Casters.)
4 1 8 3 +	U A L G +	G S +	G S +	0 3 +	E 0 0 5	

	<b>4183</b>	Sassy® Plastic Stack Chair, with Arms & Casters	4183BL	400.00	800.00	2	36	145	13.92	250
		Seat Height: 18¼"	4183GS							
		Seat Size: 18"W x 18"D	4183WH							
		Back Size: 16½"W x 12¾"H								
Overall Size: 25½"W x 22¾"D x 34¼"H										
<b>Solid Plastic: Black-BL, Grass-GS, White-WH</b>										
* Only available to order by Carton.										
All Sassy Chairs meet CAL 133 Standards, \$50.00 up-charge required per chair for upholstered styles (not available in vinyl).										
	<b>4083</b>	Soft Caster for Sassy® Stack Chairs	4083BL	52.00	52.00	Set/4	1	1	0.07	65
	Size: 1½"W x 2¼"D x 3¼"H									

\*See page 51 for Chair Features and Chair Functions.

# Seating Series

Safco® Products marketing materials are designed to be used as sales tools for our Dealer network.

Model #	Description	Fabric Grades/ Model #	List Price Ea.	List Carton Price	Quantity Per Carton	Actual Weight	S-Parcel Billable Weight	Carton Cube	Freight Class
<b>Sassy® Series Bistro-Height Seating</b>									
<b>4187 Series</b>									
	<b>4187CHAL</b>	Sassy® Bistro-Height, Armless, Plastic (CHAL)	Plastic	595.00	595.00	1	39	174	150
		Sassy® Bistro-Height, Armless, Upholstered (UCAL)	01	645.00	645.00				
		Seat Height: 30"	02	670.00	670.00				
		Seat Size: 18"W x 18"D	03	701.00	701.00				
		Back Size: 16½"W x 12¾"H	COM	670.00	670.00				
	Overall Size: 22¾"W x 23"D x 47"H								
	COM Yardage: 0.75 yds.								

	<b>4187CHWA</b>	Sassy® Bistro-Height, with Arms, Plastic (CHWA)	Plastic	638.00	638.00	1	39	174	150
		Sassy® Bistro-Height, with Arms, Upholstered (UCWA)	01	690.00	690.00				
		Seat Height: 30"	02	715.00	715.00				
		Seat Size: 18"W x 18"D	03	744.00	744.00				
		Back Size: 16½"W x 12¾"H	COM	715.00	715.00				
	Overall Size: 24¾"W x 23"D x 47"H								
	COM Yardage: 0.75 yds.								

All Sassy Chairs meet CAL 133 Standards, \$50.00 up-charge required per chair for upholstered styles (not available in vinyl).

PLEASE CHOOSE OPTIONS FROM BELOW:

Model	Style	Plastic Back	Plastic Seat	Fabric Grade	Fabric
4187	CHAL-Plastic, Bistro-Height, Armless UCAL-Upholstered, Bistro-Height, Armless CHWA-Plastic, Bistro-Height, with Arms UCWA-Upholstered, Bistro-Height, with Arms	BL-Black BU-Blue GR-Gray GS-Grass OR-Orange RD-Red WH-White YE-Yellow	BL-Black BU-Blue GR-Gray GS-Grass OR-Orange RD-Red WH-White YE-Yellow	01 02 03 COM	See pgs. 52-53 for Grades 01 - 03 fabric swatches
<b>Example:</b> 4 1 8 7 +	U C A L +	B L +	B L +	0 2 +	F R 0 3

Office Suites  
Seating  
Tables & Desks  
Meeting Essentials  
Personal Organization  
Ergonomics  
High Density Storage  
Storage & Filing  
Facilities  
Technology Furniture  
Art & Engineering  
K-12 Education  
SAFE Collection Addendum

Model #	Description	Fabric Grades/Model #	List Price Ea.	List Carton Price	Quantity Per Carton	Actual Weight	S-Parcel Billable Weight	Carton Cube	Freight Class	
<b>Sassy® Series Task Chair</b>										
4182 Series <b>1 5 6 11 12</b> * Fabric Grade										
	4182PMAL Sassy® Task Chair Armless, Plastic Back & Seat (PMAL) Sassy® Manager Armless, Upholstered Seat (UMAL) Seat Height Adjustment: 17" - 22" Seat Size: 18"W x 18"D Back Size: 16½"W x 12¼"H Overall Height Range: 33" - 38" COM Yardage: 0.75 yds.	Plastic	646.00	646.00	1	38	98	9.39	250	
		01	736.00	736.00						
		02	761.00	761.00						
		03	789.00	789.00						
		COM	761.00	761.00						
	4182PMWA Sassy® Task Chair with Arms, Plastic Back & Seat (PMWA) Sassy® Manager with Arms, Upholstered Seat (UMWA) Seat Height Adjustment: 17" - 22" Seat Size: 18"W x 18"D Back Size: 16½"W x 12¼"H Overall Height Range: 33" - 38" COM Yardage: 0.75 yds.	Plastic	729.00	729.00	1	38	98	9.39	250	
		01	798.00	798.00						
		02	826.00	826.00						
		03	854.00	854.00						
		COM	826.00	826.00						

Model #	Description	Fabric Grades/Model #	List Price Ea.	List Carton Price	Quantity Per Carton	Actual Weight	S-Parcel Billable Weight	Carton Cube	Freight Class	
<b>Sassy® Task Chair - Extended-Height</b>										
4182 Series <b>1 5 6 11 12</b> * Fabric Grade										
	4182PHAL Sassy® Ext-Height Armless, Plastic Back & Seat (PHAL) Sassy® Ext-Height Armless, Upholstered Seat (UHAL) Seat Height Adjustment: 23" - 33" Seat Size: 18"W x 18"D Back Size: 16½"W x 12¼"H Overall Height Range: 40" - 50" COM Yardage: 0.75 yds.	Plastic	709.00	709.00	1	38	98	9.39	250	
		01	781.00	781.00						
		02	808.00	808.00						
		03	836.00	836.00						
		COM	808.00	808.00						
	4182PHWA Sassy® Ext-Height with Arms, Plastic Back & Seat (PHWA) Sassy® Ext-Height with Arms, Upholstered Seat (UHWA) Seat Height Adjustment: 23" - 33" Seat Size: 18"W x 18"D Back Size: 16½"W x 12¼"H Overall Height Range: 40" - 50" COM Yardage: 0.75 yds.	Plastic	775.00	775.00	1	38	98	9.39	250	
		01	844.00	844.00						
		02	874.00	874.00						
		03	898.00	898.00						
		COM	874.00	874.00						

All Sassy Chairs meet CAL 133 Standards, \$50.00 up-charge required per chair for upholstered styles (not available in vinyl).

PLEASE CHOOSE OPTIONS FROM BELOW:

Model	Style	Plastic Back	Plastic Seat	Fabric Grade	Fabric	Casters
4182	PMWA-Plastic, Manager with Arms UMWA-Upholstered, Manager with Arms PMAL-Plastic, Manager Armless UMAL-Upholstered, Manager Armless PHWA-Plastic, Extended-Height with Arms UHWA-Upholstered, Extended-Height with Arms PHAL-Plastic, Extended-Height Armless UHAL-Upholstered, Extended-Height Armless	BL-Black BU-Blue GR-Gray GS-Grass OR-Orange RD-Red WH-White YE-Yellow	BL-Black BU-Blue GR-Gray GS-Grass OR-Orange RD-Red WH-White YE-Yellow	01 02 03 COM	See pgs. 52-53 for Grades 01 - 03 fabric swatches	4082 Soft Casters 0000 Standard Carpet Casters
Example: 4 1 8 2 +	UMWA +	BL +	BL +	0 2	F R 0 3 +	4 0 8 2 (Enter 0000 for Standard Carpet Casters.)

	4182 Sassy® Task Plastic Swivel Chair Seat Height: 17" - 22" Seat Size: 18"W x 18"D Back Size: 16½"W x 12¼"H Overall Height Range: 33" - 38" Solid Plastic: Black-BL, Grass-GS, White-WH	<b>1 5 6 11 12</b> *	4182BL	730.00	730.00	1	32	98	9.12	250	
			4182GS								
			4182WH								



	4082 Soft Caster for Task Chairs	4082BL	60.00	60.00	Set/5	2	2	0.1	65
--	----------------------------------	--------	-------	-------	-------	---	---	-----	----



\*See page 51 for Chair Features and Chair Functions.

# Seating Series

Safco® Products marketing materials are designed to be used as sales tools for our Dealer network.

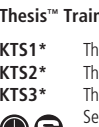
Office Suites  
Seating  
Tables & Desks  
Meeting Essentials  
Personal Organization  
Ergonomics  
High Density Storage  
Storage & Filing  
Facilities  
Technology Furniture  
Art & Engineering  
K-12 Education  
SAFE Collection Addendum

Model #	Description	Fabric Grades/ Model #	List Price Ea.	List Carton Price	Quantity Per Carton	Actual Weight	S-Parcel Billable Weight	Carton Cube	Freight Class
<b>Thesis™ Training Chair</b>									
 <b>KTS1*</b>	Thesis™ Static Back Chair with Arms	KTS1SGBLK	643.00	1,286.00	2	53	53	9.1	150
 <b>KTS2*</b>	Thesis™ Static Back Chair Armless	KTS2SGBLK	614.00	1,228.00	2	47	47	7.7	150
 <b>KTS3*</b>	Thesis™ Static Back Chair with Tablet	KTS3SGBLK	806.00	1,612.00	2	64	64	9.1	125
Seat Height: 18" Seat Size: 18½"W x 17½"D Overall: 22¼"W x 22½"D x 33"H; (KTS3 24"W x 26¼"D x 33"H) <b>Plastic Backrest: Gray-G</b> <b>Fabric Seat: Black-BLK</b> * Only available to order by Carton.									

<b>Thesis™ Training Chair</b>									
 <b>KTX1*</b>	Thesis™ Flex Back Chair with Arms	KTX1SBBLK	670.00	1,340.00	2	50	50	9.1	250
 <b>KTX2*</b>	Thesis™ Flex Back Chair Armless	KTX2SBBLK	638.00	1,276.00	2	43	43	5.0	100
 <b>KTX3*</b>	Thesis™ Flex Back with Tablet Chair	KTX3SBBLK	830.00	1,660.00	2	60	60	9.1	125
Seat Height: 18" Seat Size: 18½"W x 17½"D Overall: 22¼"W x 22½"D x 33¼"H; (KTS3 24"W x 25¼"D x 33¼"H) <b>Plastic Backrest: Black-B</b> <b>Fabric Seat: Black-BLK</b> * Only available to order by Carton.									

<b>Thesis™ Static Back Training Chair Upholstered</b>										
 <b>THESIS</b>	Thesis™ Static Back Chair Armless, Upholstered Seat	Grade 1	01	913.00	1,826.00	2	53	53	7.7	125
Seat Height: 18"										
Seat Size: 18½"W x 17½"D										
Overall: 22¼"W x 22½"D x 33"H										
With Tablet Arm: 24"W x 26¼"D x 33"H										
COM Yardage: 0.75 yds. COM										
<b>Plastic Backrest: Gray</b>										
Upcharge										
Arms										
Arms										
Tablet										
Tablet Arm - Right or Left										

<b>Upholstered Thesis™ Flex Back Training Chair</b>										
 <b>THESIS</b>	Thesis™ Flex Back Chair Armless, Upholstered Seat	Grade 1	01	941.00	1,882.00	2	43	43	8.4	150
Seat Height: 18"										
Seat Size: 18½"W x 17½"D										
Overall: 22¼"W x 22½"D x 33¼"H										
With Tablet Arm: 24"W x 25¼"D x 33¼"H										
COM Yardage: 0.75 yds. COM										
<b>Plastic Backrest: Black</b>										
Upcharge										
Arms										
Arms										
Tablet										
Tablet Arm - Right or Left										

PLEASE CHOOSE OPTIONS FROM BELOW:



Model	Back Style	Arm Style	Fabric Grade	Fabric	Tablet Arm Location
THESIS	SCBK - Static Back FXBK - Flex Back	AL - Armless WA - With Arms WT - With Tablet	01 02 03 COM	See pgs. 52-53 for Grades 01 - 03 fabric swatches	LT - Left Tablet RT - Right Tablet
<b>Example:</b>					
<b>THESIS+</b>	<u>S</u> <u>C</u> <u>B</u> <u>K</u> +	<u>A</u> <u>L</u> +	<u>0</u> <u>1</u> +	<u>O</u> <u>R</u> <u>1</u> <u>3</u>	<u>L</u> <u>T</u>

Model #	Description	Fabric Grades/ Model #	List Price Ea.	List Carton Price	Quantity Per Carton	Actual Weight	S-Parcel Billable Weight	Carton Cube	Freight Class
<b>Optional Chair Glides</b>									
 <b>GLCHAIR4</b>	Chair Glides (4/pk)	GLCHAIR4	72.00	72.00	4	1	1	0.0	100

<b>Thesis™ Extended-Height Task Chair 1 5*</b>									
 <b>KSX1</b>	Thesis™ Flex Back Extended-Height Task Chair with Arms	KSX1SBBLK	751.00	751.00	1	48	48	4.8	150
Seat Height: 21½"-29½"									
Overall: 22¼"W x 20½"D x 38-46"H									
<b>Fabric Seat: Black-SB</b>									
<b>Plastic Backrest: Black-BLK</b>									

\*See page 51 for Chair Features and Chair Functions.

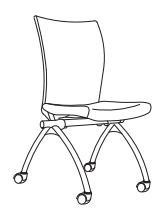

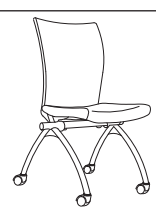
Model #	Description	Fabric Grades/Model #	List Price Ea.	List Carton Price	Quantity Per Carton	Actual Weight	S-Parcel Billable Weight	Carton Cube	Freight Class		
<b>Valoré® High-Back Chair</b>											
	<b>TSH1</b>	Valoré® Training Chair with Integrated Arms Seat Height: 18½" Seat Size: 19"W x 17"D x 18"H Overall: 23"W x 24"D x 36½"H <b>Mesh Seat Back:</b> Black-BB, Red-BR, Silver-BS <b>Fabric Seat:</b> Black <b>Legs:</b> Chrome	TSH1BB	696.00	1,392.00	2	53	53	14.1	250	
			TSH1BR								
			TSH1BS								
	<b>TSH1</b>	Valoré® Training Chair with Integrated Arms Black Plastic Accents - CRB White Plastic Accents - WHB Seat Height: 18½" Seat Size: 19"W x 17"D x 18"H Overall: 23"W x 24"D x 36½"H <b>Mesh Back:</b> Onyx <b>Fabric Seat:</b> Canter Onyx Vinyl-V <b>Legs:</b> Chrome <b>* Only available to order by Carton.</b>	TSH1CRBVONYX	1,038.00	2,076.00	2	53	53	14.1	250	
			TSH1WHBVONYX	1,106.00	2,212.00	2	53	53	14.1	250	
<b>Valoré® Training Chair Armless</b>											
	<b>TSH2</b>	Valoré® Training Chair Armless Seat Height: 18½" Seat Size: 18¾"W x 17"D x 18"H Overall: 20"W x 24"D x 36½"H <b>Mesh Seat Back:</b> Black-BB, Red-BR, Silver-BS <b>Fabric Seat:</b> Black <b>Legs:</b> Chrome	TSH2BB	692.00	1,384.00	2	50	50	12.1	250	
			TSH2BR								
			TSH2BS								
	<b>TSH2</b>	Valoré® Training Chair Armless Black Plastic Accents - CRB White Plastic Accents - WHB Seat Height: 18½" Seat Size: 18¾"W x 17"D x 18"H Overall: 20"W x 24"D x 36½"H <b>Mesh Back:</b> Onyx <b>Fabric Seat:</b> Canter Onyx Vinyl-V <b>Legs:</b> Chrome <b>* Only available to order by Carton.</b>	TSH2CRBVONYX	1,010.00	2,020.00	2	50	50	12.1	250	
			TSH2WHBVONYX	1,079.00	2,158.00	2	50	50	12.1	250	
<b>Valoré® Upholstered High-Back Chair</b>											
	<b>TSH1F</b>	Valoré® Upholstered Training Chair with Integrated Arms Seat Height: 18½" Seat Size: 19"W x 17"D x 18"H Overall: 23"W x 24"D x 36½"H <b>Mesh Back:</b> : Onyx, Tan, Green, Blue, Gray, Black, Red, and Silver <b>Legs:</b> Black, Chrome, Silver	Black Plastic Accents - BL	01	983.00	1,966.00	2	55	55	14.1	250
			White Plastic Accents - WH	01	1,051.00	2,102.00	2	55	55	14.1	250
				02	54.00	108.00					
			03	106.00	212.00						
			COM	54.00	108.00						
			<b>* Only available to order by Carton.</b>								
<b>Valoré® Upholstered Training Chair Armless</b>											
	<b>TSH2F</b>	Valoré® Upholstered Training Chair Armless Seat Height: 18½" Seat Size: 18¾"W x 17"D x 18"H Overall: 20"W x 24"D x 36½"H <b>Mesh Back:</b> : Onyx, Tan, Green, Blue, Gray, Black, Red, and Silver <b>Legs:</b> Black, Chrome, Silver	Black Plastic Accents - BL	01	953.00	1,906.00	2	51	51	14.1	250
			White Plastic Accent - WH	01	1,022.00	2,044.00	2	51	51	14.1	250
				02	54.00	108.00					
			03	106.00	212.00						
			COM	54.00	108.00						
			<b>* Only available to order by Carton.</b>								

PLEASE CHOOSE OPTIONS FROM BELOW:

Model	Mesh Back	Frame	Plastic Accent	Fabric Grade	Fabric
TSH1F	ONYX - Onyx black	CR - Chrome	WH - White	01	See pgs. 52-53 for Grades 01 - 03 fabric swatches
TSH2F	TN - Tan	BL - Black	BL - Black	02	
TSH1+	GN - Green	SL - Silver		03	
	BU - Blue			COM	
	GR - Grey				
	BL - Black				
	RD - Red				
	SL - Silver				
<b>Example:</b>					
<u>T</u> <u>S</u> <u>H</u> <u>1</u> <u>F</u> <u>+</u>	<u>O</u> <u>N</u> <u>Y</u> <u>X</u> <u>+</u>	<u>B</u> <u>L</u> <u>+</u>	<u>W</u> <u>H</u> <u>+</u>	<u>0</u> <u>1</u> <u>+</u>	<u>O</u> <u>R</u> <u>1</u> <u>3</u>



**Optional Chair Glides** Available for the TSH1, TSH2 High Back and TSM2 Mid Back and TSH4F chairs.

<b>GLCHAIR4</b> Chair Glides (4/pk)	GLCHAIR4	72.00	72.00	4	1	1	0.0	100
-------------------------------------	----------	-------	-------	---	---	---	-----	-----



Model #	Description	Fabric Grades/ Model #	List Price Ea.	List Carton Price	Quantity Per Carton	Actual Weight	S-Parcel Billable Weight	Carton Cube	Freight Class
<b>Valoré® Mid Back Chair</b>									
<b>TSM2*</b>	Valoré® Mid Back Chair Seat Height: 18½" Seat Size: 18"W x 17"D x 17½"H Overall: 21½"W x 24½"D x 36"H <b>Mesh Seat Back: Black-BB</b> <b>Fabric Seat: Black</b> <b>Legs: Silver Powder Coat</b> <b>* Only available to order by Carton.</b>	TSM2BB	484.00	968.00	2	42	42	10.8	250



<b>Valoré® Height-Adjustable Task Chair 1 5 6*</b>									
<b>TSH3</b>	Valoré® Height-Adjustable Task Chair Seat Height: 18½"-22¼" Seat Size: 19½"W x 17"D x 18"H Overall: 23½"W x 20½"D x 36½"-40¼"H <b>Mesh Seat Back: Black-BB, Red-BR, Silver-BS</b> <b>Fabric Seat: Black</b> <b>Base: Aluminum</b>	TSH3BB TSH3BR TSH3BS	984.00	984.00	1	33	33	6.2	150



<b>TSH3</b>	Valoré® Height-Adjustable Task Chair Black Plastic Accents - CRB White Plastic Accents - WHB Seat Height: 18½"-22¼" Seat Size: 19½"W x 17"D x 18"H Overall: 23½"W x 20½"D x 36½"-40¼"H <b>Mesh Back: Onyx</b> <b>Fabric Seat: Canter Onyx Vinyl</b> <b>Base: Aluminum</b>	TSH3CRBVONYX TSH3WHBVONYX	1,038.00 1,106.00	1,038.00 1,106.00	1 1	33 33	33 33	6.2 6.2	150 150
-------------	---	------------------------------	----------------------	----------------------	--------	----------	----------	------------	------------

<b>TSH3F</b>	Valoré® Height-Adjustable Task Chair Seat Height: 18½"-22¼" Seat Size: 19½"W x 17"D x 18"H Overall: 23½"W x 20½"D x 36½"-40¼"H <b>Mesh Back: Onyx, Tan, Green, Blue, Gray, Black, Red, and Silver</b> <b>Base: Aluminum</b>	Black Plastic Accents - BL 01 White Plastic Accents - WH 01	965.00 1,003.00	965.00 1,003.00	1 1	33 33	33 33	6.2 6.2	150 150
			<b>Upcharge</b>						
		02	53.00	53.00					
		03	104.00	104.00					
		COM	53.00	53.00					



**Optional Chair Casters - Not for use with Big & Tall Series.**

<b>SCC</b>	Chair Casters (5/pk)	SCC	102.00	102.00	5	1	1	0.4	100
<b>SCC4</b>	Chair Casters (4/pk)	SCC4	91.00	91.00	4	1	1	0.4	100

**PLEASE CHOOSE OPTIONS FROM BELOW:**

Model	Mesh Back	Arm Style	Plastic Accent	Fabric Grade	Fabric
TSH1F TSH2F TSH1+	ONYX - Onyx black TN - Tan GN - Green BU - Blue GR - Grey BL - Black RD - Red SL - Silver ONYX+	AL - Armless WA - With Arms	WH - White BL - Black	01 02 03 COM	See pgs. 52-53 for Grades 01 - 03 fabric swatches
<b>Example:</b>					
<u>T</u> <u>S</u> <u>H</u> <u>3</u> <u>F</u> <u>+</u>	<u>O</u> <u>N</u> <u>Y</u> <u>X</u> <u>+</u>	<u>W</u> <u>A</u> <u>+</u>	<u>W</u> <u>H</u> <u>+</u>	<u>0</u> <u>1</u> <u>+</u>	<u>O</u> <u>R</u> <u>1</u> <u>3</u>

\*See page 51 for Chair Features and Chair Functions.



Model #	Description	Fabric Grades/ Model #	List Price Ea.	List Carton Price	Quantity Per Carton	Actual Weight	S-Parcel Billable Weight	Carton Cube	Freight Class	
<b>Vy™ Series Stack Chair – 350 lb. Weight Capacity</b>										
	4290 Vy™ Sled Base Stack Chair, Plastic Back & Seat	Plastic	331.00	662.00	2	30	134	12.83	250	
	 Vy™ Sled Base Stack Chair, Plastic Back, Upholstered Seat Seat Size: 18½"W x 17"D Back Size: 19½"W x 16"H Overall Size: 22½"W x 19½"D x 32½"H COM Yardage: 0.75 yds. <b>Plastic:</b> Black-BL, Crimson-CI, Green-GN, Blue-BU, White-WH <b>* Only available to order by Carton.</b>	01	363.00	726.00						
		02	400.00	800.00						
		03	440.00	880.00						
		COM	400.00	800.00						



	4290 Vy™ Straight Leg Stack Chair, Plastic Back & Seat	Plastic	355.00	710.00	2	30	134	12.83	250	
	Vy™ Straight Leg Stack Chair, Plastic Back, Upholstered Seat Seat Size: 18½"W x 17"D Back Size: 19½"W x 16"H Overall Size: 22½"W x 19½"D x 32½"H COM Yardage: 0.75 yds. <b>Plastic:</b> Black-BL, Crimson-CI, Green-GN, Blue-BU, White-WH <b>* Only available to order by Carton.</b>	01	393.00	786.00						
		02	428.00	856.00						
		03	465.00	930.00						
		COM	428.00	856.00						



PLEASE CHOOSE OPTIONS FROM BELOW:

Model	Style	Plastic Back	Plastic Seat	Fabric Grade	Fabric
4290	PPSB-Plastic Seat, Sled Base PUSB-Upholstered Seat, Sled Base PPWC-Plastic Seat, Straight Leg with Casters PPWG-Plastic Seat, Straight Leg with Glides PUWC-Upholstered Seat, Straight Leg with Casters PUWG-Upholstered Seat, Straight Leg with Glides	BL-Black CI-Crimson GN-Green BU-Blue WH-White	BL-Black CI-Crimson GN-Green BU-Blue WH-White	01 02 03 COM	See pgs. 52-53 for Grades 01 - 03 fabric swatches
4295	PSPB-Plastic Seat, Plastic Back - Bistro PUPB-Upholstered Seat, Plastic Back - Bistro				
4296	PSPB-Plastic Seat, Plastic Back - Counter PUPB-Upholstered Seat, Plastic Back - Counter				
<b>Example:</b>					
4 2 9 0+	P U S B +	L A +	L A +	0 2+	P R 0 2

\*When all Plastic fill in "00 & 0000" for Fabric Grade & Fabric.

	4291 Vy™ Straight Leg Stack Chair, Plastic Back & Seat	4291BL	355.00	710.00	2	59	123	11.78	150
	 Seat Size: 18½"W x 17"D Back Size: 19½"W x 16"H Overall Size: 22½"W x 19½"D x 32½"H <b>Plastic:</b> Black-BL <b>* Only available to order by Carton.</b>								

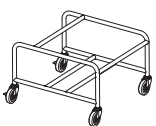
	4292 Vy™ Sled Base Stack Chair, Plastic Back & Seat	4292BL	331.00	662.00	2	59	134	12.83	150
	 Seat Size: 18½"W x 17"D Back Size: 19½"W x 16"H Overall Size: 22½"W x 19½"D x 32½"H <b>Plastic:</b> Black-BL <b>* Only available to order by Carton.</b>								

<b>Sled Base Stack Chair Cart</b>									
	4190SL Sled Base Stack Chair Cart	4190SL	288.00	288.00	1	20	57	5.31	70
	 Can stack 20 units depending on the chair (For Agiliti™, Veer™, Pique™, Reve™, Vy™ & Curreant™ High-Density Stack Chairs)								

# Seating Series

Safco® Products marketing materials are designed to be used as sales tools for our Dealer network.

Model #	Description	Fabric Grades/ Model #	List Price Ea.	List Carton Price	Quantity Per Carton	Actual Weight	S-Parcel Billable Weight	Carton Cube	Freight Class	
<b>Vy™ Sled Base Bistro-Height Chair – 350 lb. Weight Capacity</b>										
4295	Vy™ Sled Base Bistro-Height, Plastic Back & Seat Vy™ Sled Base Bistro-Height, Plastic Back, Upholstered Seat Seat Size: 18½"W x 17"D Back Size: 19½"W x 15"H Overall Size: 18"W x 22"D x 45"H COM Yardage: 0.75 yds. <b>Plastic:</b> Black-BL, Crimson-CI, Green-GN, Blue-BU, White-WH	Plastic	440.00	440.00	1	39	174	16.67	150	
		01	480.00	480.00						
		02	514.00	514.00						
		03	551.00	551.00						
		COM	514.00	514.00						
4295	Vy™ Sled Base Bistro-Height Chair, Plastic Back & Seat Seat Size: 18½"W x 17"D Back Size: 19½"W x 15"H Overall Size: 18"W x 22"D x 45"H <b>Plastic:</b> Black-BL	4295BL	439.00	439.00	1	69	174	16.67	150	





<b>Vy™ Series Sled Base Counter-Height Chair – 350 lb. Weight Capacity</b>										
4296	Vy™ Sled Base Counter-Height, Plastic Back & Seat Vy™ Sled Base Counter-Height, Plastic Back, Upholstered Seat Seat Size: 18"W x 22"D Back Size: 18"W x 16"H Overall Size: 18"W x 22"D x 42"H COM Yardage: 0.75 yds. <b>Plastic:</b> Black-BL, Crimson-CI, Green-GN, Blue-BU, White-WH	Plastic	430.00	430.00	1	19	108	10.33	300	
		01	491.00	491.00						
		02	528.00	528.00						
		03	565.00	565.00						
		COM	528.00	528.00						
4296	Vy™ Sled Base Counter-Height Chair, Plastic Back & Seat Seat Size: 18"W x 22"D Back Size: 18"W x 16"H Overall Size: 18"W x 22"D x 42"H <b>Plastic:</b> Black-BL	4296BL	430.00	430.00	1	19	108	10.33	300	



PLEASE CHOOSE OPTIONS FROM BELOW:

Model	Style	Plastic Back	Plastic Seat	Fabric Grade	Fabric
4295	PSPB-Plastic Seat, Plastic Back - Bistro PUPB-Upholstered Seat, Plastic Back - Bistro	BL-Black CI-Crimson GN-Green BU-Blue WH-White	BL-Black CI-Crimson GN-Green BU-Blue WH-White	01	See pgs. 52-53 for Grades 01 - 03 fabric swatches
4296	PSPB-Plastic Seat, Plastic Back - Counter PUPB-Upholstered Seat, Plastic Back - Counter			02	
<b>Example:</b>				03	
4 2 9 5+	P U P B +	L A +	L A +	0 2+	P R 0 2

\*When all Plastic fill in "00 & 0000" for Fabric Grade & Fabric.

Model #	Description	Fabric Grades/ Model #	List Price Ea.	List Carton Price	Quantity Per Carton	Actual Weight	S-Parcel Billable Weight	Carton Cube	Freight Class
<b>Medina™ Task Chair</b>									
	<b>6830</b> Medina™ Task Chair, Mesh Back Seat Height: 18" - 22" Seat: 18"W x 18"D Back: 17½"W x 18½"H Overall : 25"W x 25"D x 34½" - 38"H	<b>1 4 5 10 11 19*</b>	6830	668.00	668.00	1	55	76	125
<b>Mesh Back</b> Mesh: Onyx, Gray, Green, Blue, Tan		Upcharge N/C N/C							
<b>Seat Upholstery</b> 5-Day Ship		N/C N/C							
Grade 1		01	N/C	N/C					
Grade 2		02	45.00	45.00					
Grade 3		03	136.00	136.00					
COM Yardage: 0.75 yds.		COM	45.00	45.00					
<b>Mechanism</b> Basic Mechanism		N/C N/C							
Deluxe Mechanism		240.00 240.00							
<b>Headrest</b> Headrest Upholstery		75.00 75.00							
5-Day Ship		N/C N/C							
Grade 01		01	N/C	N/C					
Grade 02		02	45.00	45.00					
Grade 03		03	136.00	136.00					
COM Yardage: 0.75 yds.		COM	45.00	45.00					
<hr/>									
	<b>6830STBL</b> Medina™ Deluxe Task Chair, Mesh Back Seat Height: 18" - 22" Seat: 18"W x 18"D Back: 17½"W x 18½"H Overall : 25"W x 25"D x 34½" - 38"H <b>Fabric: Black-BL</b>	<b>1 4 5 10 11 19*</b>	6830STBL	908.00	908.00	1	55	76	125
	<b>6830BMBL</b> Medina™ Task Chair, Mesh Back Seat Height: 18" - 22" Seat: 18"W x 18"D Back: 17½"W x 18½"H Overall : 25"W x 25"D x 34½" - 38"H <b>Fabric: Black-BL</b>	<b>1 5 6 11 12 19*</b>	6830BMBL	668.00	668.00	1	55	76	125

PLEASE CHOOSE OPTIONS FROM BELOW:

Model	Headrest	Mesh Back	Fabric Grade	Seat Fabric	Headrest Fabric	Mechanism	Caster Option
6830	N - No Y - Yes	ON - Onyx Mesh TN - Tan Mesh GN - Green Mesh BU - Blue Mesh GR - Grey Mesh	01 02 03 COM	See pgs. 52-53 for Grades 01 - 03 Fabric Swatches	See pgs. 52-53 for Grades 01 - 03 Fabric Swatches	BM - Basic Mech ST - Deluxe Mech	ST - Standard Caster (Carpet) HF - Soft Caster (Hard Floor) HFP - Premium Open Wheel (Hard Floor) \$65 upcharge
<b>Example:</b> 6830+	Y +	B U +	0 1 +	O R 1 3 +	O R 1 3 +	S T +	S T +

\*See page 51 for Chair Features and Chair Functions.

# Seating Series

Safco® Products marketing materials are designed to be used as sales tools for our Dealer network.

Model #	Description	Fabric Grades/ Model #	List Price Ea.	List Carton Price	Quantity Per Carton	Actual Weight	S-Parcel Billable Weight	Carton Cube	Freight Class
	<b>Medina™ Extended-Height Seating</b>								
	<b>6827</b> Medina™ Extended-Height Task Chair, Mesh Back <b>1 5 6*</b>	6827BL	708.00	708.00	1	32	32	6.29	175
	Seat Height: 23" - 33" Seat: 18"W x 18"D Back: 18"W x 18"H Overall : 28"W x 28"D x 38" - 48"H								
	<b>Mesh Back</b> Mesh: Onyx, Gray, Green, Blue, Tan <b>Seat Upholstery</b> 5-Day Ship Grade 1 Grade 2 Grade 3 COM Yardage: 0.75 yds.								
							Upcharge		
							N/C	N/C	
							N/C	N/C	
							45.00	45.00	
							136.00	136.00	
							45.00	45.00	

	<b>6827BL</b> Medina™ Extended-Height Task Chair, Mesh Back <b>1 5 6*</b>	6827BL	708.00	708.00	1	32	32	6.29	175
	Seat Height: 23" - 33" Seat: 18"W x 18"D Back: 18"W x 18"H Overall : 28"W x 28"D x 38" - 48"H <b>Fabric: Black-BL</b>								

	<b>Medina™ Conference</b>								
	<b>6828</b> Medina™ Conference Chair, Mesh Back <b>1 5 6*</b>	6828BL	609.00	609.00	1	32	32	6.29	175
	Seat Height: 17" - 22" Seat: 18"W x 18"D Back: 18"W x 18"H Overall : 28"W x 28"D x 32" - 37"H								
	<b>Mesh Back</b> Mesh: Onyx, Gray, Green, Blue, Tan <b>Seat Upholstery</b> 5-Day Ship Grade 1 Grade 2 Grade 3 COM Yardage: 0.75 yds.								
							Upcharge		
							N/C	N/C	
							N/C	N/C	
							45.00	45.00	
							136.00	136.00	
							45.00	45.00	

	<b>Medina™ Guest Seating</b>								
	<b>6829</b> Medina™ Guest Chair, Mesh Back	6829BL	467.00	934.00	2	32	32	6.29	175
	Seat Height: 18" Seat: 18"W x 18"D Back: 18"W x 18"H Overall : 23½"W x 23½"D x 33½"H								
	<b>Mesh Back</b> Mesh: Onyx, Gray, Green, Blue, Tan <b>Seat Upholstery</b> 5-Day Ship Grade 1 Grade 2 Grade 3 COM Yardage: 0.75 yds.								
							Upcharge		
							N/C	N/C	
							N/C	N/C	
							45.00	90.00	
							136.00	272.00	
							45.00	90.00	

PLEASE CHOOSE OPTIONS FROM BELOW:

Model	Mesh Back	Fabric Grade	Fabric	Caster Option
6829	ONYX - Onyx Black	01	See pgs. 52-53 for Grades 01 - 03 fabric swatches	ST - Standard Caster (Carpet) HF - Soft Caster (Hard Floor) HFP - Premium Open Wheel (Hard Floor) \$65 upcharge
6828	TN - Tan	02		
6827	GN - Green BU - Blue GR - Grey	03 COM		
<b>Example:</b> 6 8 2 8 +	<b>B U +</b>	<b>0 1 +</b>		

	<b>Medina™ Conference &amp; Guest Seating</b>								
	<b>6828BL</b> Medina™ Conference Chair, Mesh Back <b>1 5 6*</b>	6828BL	609.00	609.00	1	32	32	6.29	175
Seat Height: 17" - 22" Seat: 18"W x 18"D Back: 18"W x 18"H Overall : 28"W x 28"D x 32" - 37"H <b>Fabric: Black-BL</b>									

	<b>6829BL</b> Medina™ Guest Chair, Mesh Back	6829BL	467.00	934.00	2	32	32	6.29	175
	Seat Height: 18" Seat: 18"W x 18"D Back: 18"W x 18"H Overall : 23½"W x 23½"D x 33½"H <b>Fabric: Black-BL</b>								

\*See page 51 for Chair Features and Chair Functions.

Office Suites  
Seating  
Tables & Desks  
Meeting Essentials  
Personal Organization  
Ergonomics  
High Density Storage  
Storage & Filing  
Facilities  
Technology Furniture  
Art & Engineering  
K-12 Education  
SAFE Collection Addendum

Model #	Description	Fabric Grades/ Model #	List Price Ea.	List Carton Price	Quantity Per Carton	Actual Weight	S-Parcel Billable Weight	Carton Cube	Freight Class
<b>7825</b>	<b>Commute Series Task Chair</b> <sup>NEW</sup> Task Seat Height: 18¼" -22¼" Task Chair Overall : 25"W x 25"D x 34"H-38"H		599.00	599.00	1	34	53	5.1	125
	<b>Seat Upholstery</b>								
	Plastic Seat								
	Grade 1	01	100.00	100.00					
	Grade 2	02	145.00	145.00					
	Grade 3	03	191.00	191.00					
	COM Yardage: 0.75 yds.	COM	145.00	145.00					
	Add Arms		99.00	99.00					
	Extended Height with Footring		100.00	100.00					
	Extended Seat Height: 22¼" -32¼"								
	Extended Chair Overall : 25"W x 25"D x 38"H -48"H								

PLEASE CHOOSE OPTIONS FROM BELOW:

Model	Back Color	Seat Color	Back Handle Color	Upholstered Fabric Grade	Upholstered Fabric	Optional Arms	Seat Height	Caster	
7825	BL-Black GR-Gray RD-Red	BL-Black** GR-Gray** RD-Red** UP-Upholstered	BL-Black GR-Gray	01 02 03 COM	See pgs. 52-53 for Grades 01-03	AL- Armless WA-With Arms	ST-Standard EX-Extended	ST-Standard Carpet HF-Hard Floor	
<b>Example:</b>	<u>7</u> <u>8</u> <u>2</u> <u>5</u> +	<u>B</u> <u>L</u> +	<u>U</u> <u>P</u> +	<u>G</u> <u>R</u> +	<u>0</u> <u>1</u> +	<u>O</u> <u>R</u> <u>1</u> <u>8</u> +	<u>W</u> <u>A</u> +	<u>S</u> <u>T</u> +	<u>S</u> <u>T</u>

Model #	Description	Fabric Grades/ Model #	List Price Ea.	List Carton Price	Quantity Per Carton	Actual Weight	S-Parcel Billable Weight	Carton Cube	Freight Class
<b>7826</b>	<b>Commute Series Guest Chair</b> <sup>NEW</sup> Task Seat Height: 19" Chair Overall : 25"W x 25"D x 34¾"H		699.00	699.00	1	30	50	5.1	125
	<b>Seat Upholstery</b>								
	Plastic Seat								
	Grade 1	01	100.00	100.00					
	Grade 2	02	145.00	145.00					
	Grade 3	03	191.00	191.00					
	COM Yardage: 0.75 yds.	COM	145.00	145.00					
	Add Arms		99.00	99.00					

PLEASE CHOOSE OPTIONS FROM BELOW:





Model	Back Color	Seat Color	Back Handle Color	Upholstered Fabric Grade	Upholstered Fabric	Optional Arms	
7826	BL-Black GR-Gray RD-Red	BL-Black** GR-Gray** RD-Red** UP-Upholstered	BL-Black GR-Gray	01 02 03 COM	See pgs. 52-53 for Grades 01-03	AL-Armless WA-With Arms	
<b>Example:</b>	<u>7</u> <u>8</u> <u>2</u> <u>6</u> +	<u>B</u> <u>L</u> +	<u>U</u> <u>P</u> +	<u>G</u> <u>R</u> +	<u>0</u> <u>1</u> +	<u>O</u> <u>R</u> <u>1</u> <u>8</u> +	<u>W</u> <u>A</u>

Model #	Description	Fabric Grades/ Model #	List Price Ea.	List Carton Price	Quantity Per Carton	Actual Weight	S-Parcel Billable Weight	Carton Cube	Freight Class
<b>7825BL</b>	<b>Commute Series Task Chair</b> <sup>NEW</sup> Black Plastic Seat Seat Height: 18¼" -22¼" Chair Overall : 25"W x 25"D x 34"H-38"H		599.00	599.00	1	34	53	5.1	125
<b>7826BL</b>	<b>Commute Series Guest Chair</b> <sup>NEW</sup> Black Plastic Seat Task Seat Height: 19" Chair Overall : 25"W x 25"D x 34¾"H		699.00	699.00	1	30	50	5.1	125
<b>7827BL</b>	<b>Commute Extended Height Chair</b> <sup>NEW</sup> Black Plastic Seat Seat Height: 18¼" -22¼" Chair Overall : 25"W x 25"D x 34"H-38"H		699.00	699.00	1	38	53	5.1	125
<b>7829BL</b>	<b>Commute Arm Set</b> Optional Commute Arm Set		99.00	99.00	2	6	10	0.91	70





\*See page 51 for Chair Features and Chair Functions.

# Task Seating

Safco® Products marketing materials are designed to be used as sales tools for our Dealer network.

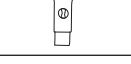







Model #	Description	Fabric Grades/ Model #	List Price Ea.	List Carton Price	Quantity Per Carton	Actual Weight	S-Parcel Billable Weight	Carton Cube	Freight Class
	<b>Medina™ Task Chair</b> <b>6830</b> Medina™ Deluxe Task Chair, Mesh Back <b>1 4 5 10 11 19</b> * Seat Height: 18" - 22" Seat: 18"W x 18"D Back: 17½"W x 18½"H Overall : 25"W x 25"D x 34½" - 38"H Fabric: Black-BL		908.00	908.00	1	55	76	7.16	125
	<b>6830</b> Medina™ Task Chair, Mesh Back <b>1 5 6 11 12 19</b> * Seat Height: 18" - 22" Seat: 18"W x 18"D Back: 17½"W x 18½"H Overall : 25"W x 25"D x 34½" - 38"H Fabric: Black-BL		668.00	668.00	1	55	76	7.16	125
	<b>Shell™ Chair</b> <b>7013</b> Shell™ Desk Chair Seat Height: 17" - 20" Overall: 26"W x 26"D x 38"H Plastic Colors: Black-BL, White-WH Optional Accessories: 5132 Hard Floor Casters and 5138 2" Nylon Glides, see Page 85	7013BL 7013WH	499.00	499.00	1	38	55	5.25	250
	<b>Vue™ Mesh Intensive-Use Task Chair – 500 lb. Capacity</b> <b>1 2 5 13</b> * <b>3397</b> Vue™ Mesh Intensive-Use 24/7 Task Chair Seat Height: 17½" - 20½" Seat: 20"W x 20"D Back: 18¾"W x 18"H Overall Height Range: 31" - 37" Fabric: Black-BL, Black Vinyl-BV For Arm Kit see 3399BL on page 63.	3397BL 3397BV	773.00	773.00	1	48	98	8.92	150

# Extended Height-Task Seating

	<b>Apprentice II Extended-Height Seating</b> <b>1 2 5</b> * <b>7084BL</b> Apprentice II Extended-Height Chair Seat Height: 22" - 32" Seat: 20"W x 19"D Back: 18"W x 19"H Overall Height Range: 44½" - 54" Fabric: Black Vinyl-BL	7084BL	794.00	794.00	1	42	71	6.53	125
	<b>6689BL</b> Adjustable T-Pad Arm Set	6689BL	197.00	197.00	1/Pair	9	9	0.61	100
	<b>5138</b> 2" Nylon Glides Optional Accessories: 5132 Hard Floor Casters, see Page 85	5138	54.00	54.00	Set/5	1	1	0.03	65
	<b>Medina™ Extended-Height Seating</b> <b>6827</b> Medina™ Extended-Height Task Chair, Mesh Back Seat Height: 23" - 33" Seat: 18"W x 18"D Back: 18"W x 18"H Overall : 28"W x 28"D x 38" - 48"H Fabric: Black-BL	6827BL	708.00	708.00	1	32	32	6.29	175
	<b>Metro™ Extended-Height Seating</b> <b>1 5 6 11</b> * <b>3442</b> Metro™ Extended-Height Chair Seat Height: 23" - 33" Seat: 18¾"W x 17"D Back: 17¾"W x 16"H Overall Height Range: 39" - 49" Fabric: Black-BL, Black Vinyl-BV Optional Accessories: 5132 Hard Floor Casters and 5138 2" Nylon Glides, see Page 85	3442BL 3442BV	591.00	591.00	1	34	64	6.11	150
	<b>3495BL</b> Adjustable Arm Kit for Metro™ Chair	3495BL	163.00	163.00	1 Set	8	8	0.56	100

\*See page 51 for Chair Features and Chair Functions.



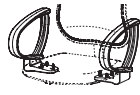





Model #	Description	Fabric Grades/Model #	List Price Ea.	List Carton Price	Quantity Per Carton	Actual Weight	S-Parcel Billable Weight	Carton Cube	Freight Class
<b>Precision Extended-Height Seating 1 2 3 5 *</b>									
	<b>3401</b> Precision Extended-Height Chair, Footring (L) (S) Seat Height: 23" - 33" Seat: 17½"W x 16"D Back: 16¼"W x 14"H Overall Height Range: 42" - 54" Fabric: Black-BL <b>Optional Accessories:</b> 5132 Hard Floor Casters and 5138 2" Nylon Glides, see Page 85	3401BL	592.00	592.00	1	33	59	5.08	125
	<b>3406</b> Precision Extended-Height Vinyl Chair, Footring (L) (S) Seat Height: 23" - 33" Seat: 17½"W x 16"D Back: 16¼"W x 14"H Overall Height Range: 42" - 54" Vinyl: Black-BL <b>Optional Accessories:</b> 5132 Hard Floor Casters and 5138 2" Nylon Glides, see Page 85	3406BL	592.00	592.00	1	33	59	5.08	125
	<b>5138</b> 2" Nylon Glides (L) (S)	5138	54.00	54.00	Set/5	1	1	0.03	65
<b>Shell™ Chair</b>									
	<b>7014</b> Shell™ Extended-Height Chair (L) (S) Seat Height: 22" - 32" Overall: 29"W x 29"D x 48"H Plastic Colors: Black-BL, White-WH <b>Optional Accessories:</b> 5132 Hard Floor Casters and 5138 2" Nylon Glides, see Page 85	7014BL 7014WH	570.00	570.00	1	42	66	6.16	250
<b>Thesis™ Extended-Height Task Chair 1 5 *</b>									
	<b>KSX1</b> Thesis™ Flex Back Extended-Height Task Chair with Arms (L) (S) Seat Height: 21½" - 29½" Overall: 22¼"W x 20½"D x 38-46"H Plastic Backrest: Black-BLK Fabric Seat: Black-SB	KSX1SBBLK	751.00	751.00	1	48	48	4.8	150
<b>Vue™ Mesh Heavy-Duty Extended-Height Seating 1 2 5 13 *</b>									
	<b>3394</b> Vue™ Mesh Heavy-Duty Extended-Height (L) (S) Weight Capacity: 350 lbs. Seat Height: 23" - 32½" Seat: 20½"W x 20"D Back: 18¼"W x 18"H Overall Height Range: 37" - 48½" Fabric: Black-BL, Black Vinyl-BV	3394BL 3394BV	895.00	895.00	1	54	107	10.16	150
	<b>3399BL</b> Adjustable Arm Set for 3394 Vue™ Heavy-Duty Task Chair (L) (S)	3399BL	80.00	160.00	1 Set	8	8	0.59	100
	<b>3395</b> Vue™ Mesh Extended-Height (L) (S) Seat Height: 23" - 33" Seat: 18"W x 17½"D Back: 17"W x 15½"H Overall Height Range: 39½" - 49½" Fabric: Black-BL, Black Vinyl-BV	3395BL 3395BV	569.00	569.00	1	34	53	5.1	125
	<b>3396BL</b> Loop Arm Kit for 3395 Vue™ Mesh Extended-Height Chair Only (L) (S)	3396BL	128.00	128.00	1 Set	6	10	0.91	70
<b>Optional Accessories:</b> 5132 Hard Floor Casters and 5138 2" Nylon Glides, see Page 85									







\*See page 51 for Chair Features and Chair Functions.

# Big & Tall

Safco® Products marketing materials are designed to be used as sales tools for our Dealer network.

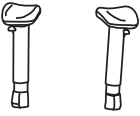
Model #	Description	Fabric Grades/ Model #	List Price Ea.	List Carton Price	Quantity Per Carton	Actual Weight	S-Parcel Billable Weight	Carton Cube	Freight Class
 3391	Alday™ 24/7 Task Chair - 500 lb. Capacity Seat Height: 17½" - 20" Seat: 20½"W x 20"D Back: 18¾"W x 18"H Overall Height Range: 35½" - 38" Fabric: Black-BL, Black Vinyl-BV	3391BL 3391BV	809.00	809.00	1	52.2	116	10.98	175
 3399BL	Adjustable Arm Set for Alday™ & Vue™ Task Chair - Black-BL	3399BL	80.00	160.00	2	8.3	9	0.67	100
 3502	Lineage™ Big & Tall High Back Chair - 500 lb. Capacity Overall: 29"W x 31"D x 44¾ - 48½" Leather: Black-BL	3502BL	1,007.00	1,007.00	1	78.4	107	9.87	125
 3503	Lineage™ Big & Tall Mid Back Chair - 400 lb. Capacity Overall: 24½"W x 30¾"D x 42 - 46" Leather: Black-BL	3503BL	852.00	852.00	1	76.8	107	9.87	125
 3504	Lineage™ Big & Tall Chair - 350 lb. Capacity Overall: 24½"W x 25½"D x 35 - 39" Leather: Black-BL	3504BL	800.00	800.00	1	71.4	91	8.87	100
 3505	Lineage™ Big & Tall All Mesh Chair - 400 lb. Capacity Overall: 29¾"W x 29¾"D x 41¼ - 45"H Fabric: Black-BL	3505BL	1,010.00	1,010.00	1	64.6	79	7.58	100

\*See page 51 for Chair Features and Chair Functions.

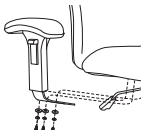

Model #	Description	Fabric Grades/Model #	List Price Ea.	List Carton Price	Quantity Per Carton	Actual Weight	S-Parcel Billable Weight	Carton Cube	Freight Class
	<b>3590BL</b> Optimus™ Big & Tall Task Chair - 400 lb. Capacity <b>1 2 5 13*</b> Seat Height: 19" - 22" Seat: 23"W x 22"D Back: 22"W x 25"H Overall: 25"W x 25"D x 42½" - 45½"H Fabric: Black-BL	3590BL	832.00	832.00	1	62	118	11.2	175
	<b>3592BL</b> Optimus™ Big & Tall Task Chair - 400 lb. Capacity Seat Height: 19" - 22" Seat: 23"W x 22"D Back: 22"W x 25"H Overall: 25"W x 25"D x 42½" - 45½"H Fabric: Black Vinyl-BL	3592BL	883.00	883.00	1	61	118	10.89	175
	<b>3591BL</b> Optimus™ Arm Kit (Set)	3591BL	215.00	215.00	1	9	11	1.04	085
	<b>3500BL</b> Serenity™ High Back Big & Tall, Black Leather - 500 lb. Capacity <b>1 5 6 11 12*</b> Seat Height: 19½" - 22½" Seat: 21½"W x 22"D Back: 22"W x 26"H	3500BL	1,288.00	1,288.00	1	62.2	126	11.78	175
	<b>3490</b> Uber™ High Back Task Chair - 500 lb. Capacity <b>1 5 6 11 12*</b> Seat Height: 19½" - 23½" Seat: 22¼"W x 20¾"D Back: 23"W x 23"H Overall Height Range: 40¾" - 44¾" Fabric: Black-BL, Black Vinyl-BV	3490BL 3490BV	958.00	958.00	1	48.2	73	7.05	125
	<b>3491</b> Uber™ Mid Back Task Chair - 500 lb. Capacity <b>1 5 6 11 12*</b> Seat Height: 18½" - 22½" Seat: 22¼"W x 20¾"D Back: 23"W x 19¾"H Overall Height Range: 36¾" - 40¾"H Fabric: Black-BL, Black Vinyl-BV	3491BL 3491BV	904.00	904.00	1	49	75	7.07	125
	<b>3492</b> Uber™ Guest Chair - 500 lb. Capacity Seat Height: 19½" Seat: 23"W x 20¾"D Back: 22½"W x 19½"H Overall: 27¼"W x 29¾"D x 35¾"H Fabric: Black Vinyl-BV	3492BV	826.00	826.00	1	53.2	119	11.12	175
	<b>3496BL</b> Adjustable T-Pad Arm Kit for Uber™ Task Chair	3496BL	215.00	215.00	1	6.4	7	0.45	100







\*See page 51 for Chair Features and Chair Functions.

# Guest, Stack & Bistro Seating

Safco® Products marketing materials are designed to be used as sales tools for our Dealer network.

Office Suites  
Seating  
Tables & Desks  
Meeting Essentials  
Personal Organization  
Ergonomics  
High Density Storage  
Storage & Filing  
Facilities  
Technology Furniture  
Art & Engineering  
K-12 Education  
SAFE Collection Addendum

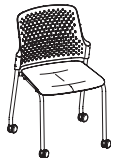

Model #	Description	Fabric Grades/ Model #	List Price Ea.	List Carton Price	Quantity Per Carton	Actual Weight	S-Parcel Billable Weight	Carton Cube	Freight Class
	<b>Bandi™ Stack Chair</b>								
	<b>4275</b> Bandi™ Stack Chair	4275BU	292.00	584.00	2	28	132	11.98	250
	Seat Height: 17½"	4275GN							
	Seat Size: 16"W x 16½"D	4275RD							
	Overall: 23¾"W x 19"D x 31"H	4275WH							
	<b>Finish: Blue-BU, Green-GN, Red-RD, White-WH</b>								
	<b>Currant™ Stack Chair</b>								
	<b>4271</b> Currant™ Stack Chair	4271BC	207.00	828.00	4	59	125	11.63	250
	Seat Height: 17½"								
	Seat Size: 17¾"W x 18½"D								
	Overall: 21"W x 21"D x 32"H								
	<b>Finish Seat, Back &amp; Frame: Black/Chrome-BC</b>								
	<b>Currant™ Bistro-Height Stool</b>								
	<b>4273</b> Currant™ Bistro-Height Stool	4273BC	460.00	920.00	2	20	LTL	-	16.58
	Seat Height: 30"								
	Seat Size: 17¾"W x 18½"D								
	Overall: 22¼"W x 23½"D x 44½"H								
	<b>Finish Seat, Back &amp; Frame: Black/Chrome-BC</b>								
	<b>Escalate Stacking Chairs</b>								
	<b>ESC2</b> Escalate Chair with Plastic Back and Seat	ESC2B	412.00	1,648.00	4	65	LTL	12.3	150
	Seat Height: 18"	ESC2W							
	Seat Size: 18"W x 19"D x 15"H								
	Overall: 19½"W x 21½"D x 32"H								
	<b>Plastic Back &amp; Seat: Black-B, White-W</b>								
	<b>* Only available to order by Carton.</b>								
	<b>Escalate Stacking Stools</b>								
	<b>ESS2*</b> Escalate Stool with Plastic Back and Seat	ESS2B	572.00	1,144.00	2	45	LTL	15.8	250
	Seat Height: 30"	ESS2W							
	Seat Size: 18"W x 19½"D x 15"H								
	Overall: 21½"W x 23"D x 43¾"H								
	<b>Plastic Back &amp; Seat: Black-B, White-W</b>								
	<b>* Only available to order by Carton.</b>								

Model #	Description	Fabric Grades/ Model #	List Price Ea.	List Carton Price	Quantity Per Carton	Actual Weight	S-Parcel Billable Weight	Carton Cube	Freight Class
	<b>Medina™ Conference &amp; Guest Seating</b> <b>6828</b> Medina™ Conference Chair, Mesh Back Seat Height: 17" - 22" Seat: 18"W x 18"D Back: 18"W x 18"H Overall : 28"W x 28"D x 32" - 37"H Fabric: Black-BL	6828BL	609.00	609.00	1	32	32	6.29	175
	<b>6829</b> Medina™ Guest Chair, Mesh Back Seat Height: 18" Seat: 18"W x 18"D Back: 18"W x 18"H Overall : 23½"W x 23½"D x 33½"H Fabric: Black-BL	6829BL	467.00	934.00	2	32	32	6.29	175
	<b>Two-Tier Chair Cart</b> <b>4199BL</b> Two-Tier Chair Cart Stores up to 84 folding chairs Overall: 64½"W x 33½"D x 70¼"H Finish: Black-BL	4199BL	1,165.00	1,165.00	1	98	124	11.09	100
	<b>Moto™ Stack Chair</b> <b>4184</b> Moto™ Mobile Stack Chair Seat Height: 18", Seat: 17½"W x 17"D Back: 18"W x 13¾"H Overall: 23½"W x 23"D x 31¾"H Fabric: Black-BL * Only available to order by Carton.	4184BL	395.00	790.00	2	42	147	12.73	250
	<b>Next™ Stack Chair</b> <b>4287*</b> Next™ Stack Chair, High Impact Polypropylene Back & Seat Seat Height: 17½" Seat: 17½"W x 18½"D Back: 17½"W x 15½"H Overall Size: 19½"W x 20"D x 32"H Finish: Black-BL, White-WH * Only available to order by Carton.	4287BL 4287WH	225.00	900.00	4	60	130	14.0	175
	<b>4314*</b> Next™ Stack Chair with Caster Seat Height: 17½" Seat: 17½"W x 18½"D Back: 17½"W x 15½"H Overall Size: 19½"W x 20"D x 32"H Finish: Black-BL, White-WH * Only available to order by Carton.	4314BL 4314WH	234.00	936.00	4	50	130	12.73	175
	<b>5132</b> 2" Hard Floor Casters	5132	121.00	121.00	Set/5	1	1	0.06	65
	<b>4315*</b> Next™ Bistro-Height Chair Seat Height: 17½" Seat: 17½"W x 18½"D Back: 17½"W x 15½"H Overall Size: 21½"W x 20"D x 46"H Finish: Black-BL, White-WH * Only available to order by Carton.	4315BL 4315WH	424.00	848.00	2	80	167	15.98	175



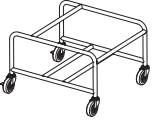

Office Suites  
Seating  
Tables & Desks  
Meeting Essentials  
Personal Organization  
Ergonomics  
High Density Storage  
Storage & Filing  
Facilities  
Technology Furniture  
Art & Engineering  
K-12 Education  
SAFE Collection Addendum







# Guest, Stack & Bistro Seating

Safco® Products marketing materials are designed to be used as sales tools for our Dealer network.

Model #	Description	Fabric Grades/ Model #	List Price Ea.	List Carton Price	Quantity Per Carton	Actual Weight	S-Parcel Billable Weight	Carton Cube	Freight Class
	<b>Pique™ Stack Chair</b> 4289BLSL* Pique™ Stack Chair Seat Height: 17½", Seat Size: 17¼"W x 18¾"D Back Size: 20"W x 19½"H Overall: 20¼"W x 19¾"D x 32"H <b>Plastic: Black-BL</b> <b>Base: Silver-SL</b> * Only available to order by Carton.	4289BLSL	280.00!	1,120.00	4	70	LTL	11.67	150
	<b>Sled Base Stack Chair Cart</b> 4190SL Sled Base Stack Chair Cart Can stack 20 units depending on the chair (For Agiliti™, Veer™, Pique™, Reve™, Vy™ & Currant™ High-Density Stack Chairs)	4190SL	288.00	288.00	1	20	57	5.31	70
	<b>Safco® Stack Chair</b> 4185* Safco® Stack Chair Seat Height: 18" Seat: 18¼"W x 16¼"D Back: 18¼"W x 12¾"H Overall: 21¼"W x 17¾"D x 30½"H <b>Color: Black-BL, Blue-BU, Charcoal-CH</b> * Only available to order by Carton	4185BL 4185BU 4185CH	164.00	656.00	4	60	LTL	14.0	150
	<b>4188</b> Stacking Chair Cart Can stack 15 units depending on the chair For use with Safco's Stack, Next and Currant Bistro-Height Chairs	4188	229.00	229.00	1	25	25	1.18	70

# Outdoor/Indoor Seating

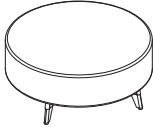
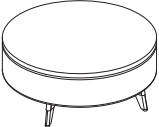
	<b>CoGo™ Steel Outdoor/Indoor Stack Chair</b> 4360 CoGo™ Steel Stack Chair Seat Size: 16½"W x 16"D Back: 21"W x 11½"H Overall: 18½"W x 22"D x 28¾"H <b>Finish: Black-BL, Red-RD</b> See matching CoGo™ Tables on page 105	4360BL 4360RD	277.00	554.00	2	40	121	11.57	250
	<b>CoGo™ Steel Outdoor/Indoor Bench</b> 4368 CoGo™ Steel Bench with Back Seat Size: 60"W x 25"D Overall: 60"W x 25"D x 30"H <b>Finish: Black-BL, Red-RD</b>	4368BL 4368RD	937.00	937.00	1	88	97	9.15	85
	<b>CoGo™ Outdoor/Indoor Tables</b> 4361 CoGo™ 30" Outdoor/Indoor Tables Overall: 30"Dia. x 29½"H <b>Finish: Black-BL, Red-RD</b>	4361BL 4361RD	460.00	460.00	1	49	49	2.96	70
	<b>4362</b> CoGo™ 36" Outdoor/Indoor Tables Overall: 36"Dia. x 29½"H <b>Finish: Black-BL, Red-RD</b>	4362BL 4362RD	542.00	542.00	1	59	59	4.18	85

Model #	Description	Fabric Grades/ Model #	List Price Ea.	List Carton Price	Quantity Per Carton	Actual Weight	S-Parcel Billable Weight	Carton Cube	Freight Class	
<b>Resi® Collection</b>										
	<b>1715</b> Resi® Bistro Stool Upholstered Fabric Seat Overall: 21½"W x 21½" D x 31"H <b>Base:</b> Solid Maple Wood with Natural Finish Legs White Powder Coated Steel Crown and Footring COM Yardage: 0.5 yd	1715	01	730.00	730.00	1	15	LTL	2.35	100
				<b>Upcharge</b>						
			02	19.00	19.00					
			03	32.00	32.00					
		COM	19.00	19.00						
	<b>1721NA</b> Resi® Bistro Table Maple Veneer Tabletop Overall: 65"W x 42"D x 42½"H <b>Base:</b> White Powder Coated Steel Stringer with Solid Maple Wood in Natural Finish Legs	1721NA		1,840.00	1,840.00	1	134	LTL	17.87	125
	<b>1716</b> Resi® Sitting-Height Stool Upholstered Fabric Seat Overall: 17½"W x 17½"D x 19½"H <b>Base:</b> White Powder Coated Steel Crown with Solid Maple Wood with Natural Finish Legs COM Yardage: 0.5 yd	1716	01	543.00	543.00	1	18	22	2.08	100
				<b>Upcharge</b>						
			02	19.00	19.00					
			03	32.00	32.00					
		COM	19.00	19.00						
	<b>1720NA</b> Resi® Sitting-Height Table Maple Veneer Tabletop Overall: 42"Dia x 29½"H <b>Base:</b> White Powder Coated Steel Stringer with Solid Maple Wood in Natural Finish Legs	1720NA		1,393.00	1,393.00	1	61	65.4	8.67	125
	<b>1714</b> Resi® Coupe Chair Upholstered Fabric Seat and Back Seat Height: 17"H Overall: 26"W x 26¼"D x 29"H <b>Base:</b> Solid Maple Wood with Natural Finish Legs COM Yardage: 1.5 yd	1714	01	1,205.00	1,205.00	1	21	LTL	12.70	250
				<b>Upcharge</b>						
			02	83.00	83.00					
			03	143.00	143.00					
		COM	83.00	83.00						
	<b>1718</b> Resi® Upholstered Ottoman Overall: 36"Dia x 15¼"H <b>Base:</b> White Powder Coated Steel Crown with Solid Maple Wood in Natural Finish Legs COM Yardage: 2.25 yd	1718	01	1,026.00	1,026.00	1	59	LTL	10.29	150
				<b>Upcharge</b>						
			02	121.00	121.00					
			03	215.00	215.00					
		COM	121.00	121.00						
	<b>1719</b> Resi® Wood and Upholstered Ottoman Maple Veneer Wooden Tabletop Overall: 36"Dia x 15¼"H <b>Base:</b> White Powder Coated Steel Crown with Solid Maple Wood in Natural Finish Legs COM Yardage: 1.25 yd	1719	01	1,177.00	1,177.00	1	83	LTL	10.61	150
				<b>Upcharge</b>						
			02	69.00	69.00					
			03	119.00	119.00					
		COM	69.00	69.00						
	<b>RESENDTNA</b> Resi® End Table - Natural Overall: 17¼"W x 17¼"D x 17"H <b>Base:</b> White Powder Coated Steel Crown with Solid Maple Wood in Natural Finish Legs	RESENDTNA		400.00	400.00	1	10	18	1.54	175







PLEASE CHOOSE OPTIONS FROM BELOW:

Model	Fabric Grade	Fabric
1714	01 02 03 COM	See pgs. 52-53 for Grades 01 - 03 fabric swatches
<b>Example:</b>		
<u>  </u> <u>  </u> <u>  </u> <u>  </u> <u>  </u> +	<u>  </u> <u>  </u> +	<u>  </u> <u>  </u> <u>  </u> <u>  </u>







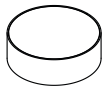
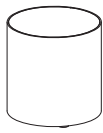
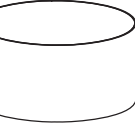
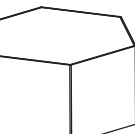













# Lounge











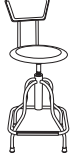



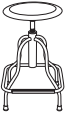







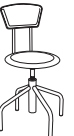

Safco® Products marketing materials are designed to be used as sales tools for our Dealer network.

Model #	Description	Fabric Grades/ Model #	List Price Ea.	List Carton Price	Quantity Per Carton	Actual Weight	S-Parcel Billable Weight	Carton Cube	Freight Class
<b>Santa Cruz® Lounge Series</b>									
 <b>VCCM</b>	Santa Cruz® Mobile Lounge Chair Seat Height: 19" Seat Size: 18½"W x 21"D x 11¾"H Overall: 31"W x 33"D x 30¾"H <b>Leather: Black-BLK</b> <b>Base: Black</b>	VCCMBLK	2,191.00	2,191.00	1	84	LTL	19.2	150
 <b>VCCMT</b>	Santa Cruz® Mobile Lounge Chair with Tablet Seat Height: 19" Seat Size: 18½"W x 21"D x 11¾"H Overall: 31"W x 33"D x 30¾"H <b>Leather: Black-BLK</b> <b>Base: Black</b>	VCCMTBLK	2,587.00	2,587.00	1	91	LTL	19.2	150
 <b>VCCS</b>	Santa Cruz® Storage Ottoman Seat Height: 19½" Seat Size: 18½"W x 18½"D x 18½"H Overall: 18½"W x 18½"D x 18½"H <b>Leather: Black-BLK</b> <b>Base: Black</b>	VCCSBLK	965.00	965.00	1	34	34	4.6	150
 <b>VCC1</b>	Santa Cruz® Chair Seat Height: 19" Seat Size: 21½"W x 22"D x 13¼"H Overall: 36"W x 34¼"D x 32¼"H <b>Leather: Black-B</b> <b>Base: Black</b>	VCC1BLKB	2,112.00	2,112.00	1	72	LTL	21.0	250
 <b>VCC2</b>	Santa Cruz® Settee Seat Height: 19" Seat Size: 41"W x 22"D x 13¼"H Overall: 55"W x 34¼"D x 32¼"H <b>Leather: Black-B</b> <b>Base: Black</b>	VCC2BLKB	3,149.00	3,149.00	1	105	LTL	32.0	250
 <b>VCC3</b>	Santa Cruz® Sofa Seat Height: 19" Seat Size: 61"W x 22"D x 13¼"H Overall: 75¼"W x 34¼"D x 32¼"H <b>Leather: Black-B</b> <b>Base: Black</b>	VCC3BLKB	4,091.00	4,091.00	1	156	LTL	43.8	250
<b>Learn Soft Seating</b>									
 <b>8121</b>	Learn 15" Round Floor Seat - Easy clean vinyl Overall Size: 15"Dia. x 5¾"H 8121GV <b>Vinyl: Black- BV, Blue- BUV, Green- GV, Red- RV</b>	8121BV 8121BUV 8121RV	242.00	242.00	1	8	11	0.93	150
<b>8121</b>	Learn 15" Round Floor Seat - Configured Vinyls Grade 2 Vinyl, Canter, Dot.com, Hathaway	8121	375.00	375.00	1	8	11	0.93	150
 <b>8122</b>	Learn 15" Cylinder Vinyl Seat - Easy clean vinyl 2 height options: 1" Levelers, 3" Tall Feet (both come in box) Overall Size: 15"Dia. x 15¼"-18"H <b>Vinyl: Black- BV, Blue- BUV, Green- GV, Red- RV</b>	8122BV 8122BUV 8122GV 8122RV	331.00	331.00	1	13.4	27	2.33	150
<b>8122</b>	Learn 15" Cylinder Vinyl Seat - Configured Vinyls Grade 2 Vinyl, Canter, Dot.com, Hathaway	8122	483.00	483.00	1	13.4	27	2.33	150
 <b>8123</b>	Learn 30" Cylinder Vinyl Ottoman - Easy clean vinyl 2 height options: 1" Levelers, 3" Tall Feet (both come in box) Overall Size: 30"Dia. x 15¼"-18"H <b>Vinyl: Blue- BUV, Green- GV, Red- RV</b>	8123BUV 8123GV 8123RV	882.00	882.00	1	40.6	93	9.19	150
<b>8123</b>	Learn 30" Cylinder Vinyl Ottoman - Configured Vinyls Grade 2 Vinyl, Canter, Dot.com, Hathaway	8123	1,072.00	1,072.00	1	40.6	93	9.19	150
 <b>8124</b>	Learn 30" Hexagon Vinyl Ottoman - Easy clean vinyl 2 height options: 1" Levelers, 3" Tall Feet (both come in box) Overall Size: 29¾"Dia. x 15¼"-18"H <b>Vinyl: Blue- BUV, Green- GV, Red- RV</b>	8124BUV 8124GV 8124RV	881.00	881.00	1	35.2	93	8.82	150
<b>8124</b>	Learn 30" Hexagon Vinyl Ottoman - Configured Vinyls Grade 2 Vinyl, Canter, Dot.com, Hathaway	8124	1,072.00	1,072.00	1	35.2	93	8.82	150

Office Suites  
Seating  
Tables & Desks  
Meeting Essentials  
Personal Organization  
Ergonomics  
High Density Storage  
Storage & Filing  
Facilities  
Technology Furniture  
Art & Engineering  
K-12 Education  
SAFE Collection Addendum

	Model #	Description	Model #	List Price Ea.	List Carton Price	Quantity Per Carton	Actual Weight	S-Parcel Billable Weight	Carton Cube	Freight Class
	<b>1730MRL2</b>  	Mirella Lounge Sofa 77"W x 30"D x 28"H Legs: Black-MRL2BLK, Silver-MRL2SLV Vinyl: Black-BL, Cognac-COG, Gray-GR	1730MRL2BLKBL 1730MRL2BLKCOG 1730MRL2BLKGR 1730MRL2SLVBL 1730MRL2SLVCOG 1730MRL2SLVGR	3,977.00	3,977.00	1	145	LTL	31.2	250
				3,977.00	3,977.00					
	<b>1731MRL2</b>  	Mirella Lounge Settee 54"W x 30"D x 28"H Legs: Black-MRL2BLK, Silver-MRL2SLV Vinyl: Black-BL, Cognac-COG, Gray-GR	1731MRL2BLKBL 1731MRL2BLKCOG 1730MRL2BLKGR 1731MRL2SLVBL 1731MRL2SLVCOG 1731MRL2SLVGR	3,123.00	3,123.00	1	95	225	21.56	250
				3,123.00	3,123.00					
	<b>1732MRL2</b>  	Mirella Lounge Chair 33"W x 30"D x 28"H Legs: Black-MRL2BLK, Silver-MRL2SLV Vinyl: Black-BL, Cognac-COG, Gray-GR	1732MRL2BLKBL 1732MRL2BLKCOG 1732MRL2BLKGR 1732MRL2SLVBL 1732MRL2SLVCOG 1732MRL2SLVGR	2,184.00	2,184.00	1	55	138	13.39	250
				2,184.00	2,184.00					
	<b>1730RESFEET4PK</b>  	Resi Lounge Sofa 77"W x 30"D x 28"H Vinyl: Black-BL, Cognac-COG, Gray-GR	1730RESFEET4PKBL 1730RESFEET4PKCOG 1730RESFEET4PKGR	3,652.00	3,652.00	1	145	LTL	31.2	250
	<b>1731RESFEET4PK</b>  	Resi Lounge Settee 54"W x 30"D x 28"H Vinyl: Black-BL, Cognac-COG, Gray-GR	1731RESFEET4PKBL 1731RESFEET4PKCOG 1731RESFEET4PKGR	2,797.00	2,797.00	1	95	225	21.56	250
	<b>1732RESFEET4PK</b>  	Resi Lounge Chair 33"W x 30"D x 28"H Vinyl: Black-BL, Cognac-COG, Gray-GR	1732RESFEET4PKBL 1732RESFEET4PKCOG 1732RESFEET4PKGR	1,859.00	1,859.00	1	55	138	13.39	250

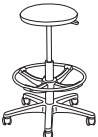











Stools

Diesel Industrial Stools										
	<b>6664</b>   	Diesel High Base with Back <b>1 5</b> * Seat Height: 22" - 27" Seat: 14" Dia. Back: 12"W x 7"H Overall: 16½"W x 16½"D x 36" - 41"H Finish: Pewter	6664	458.00	458.00	1	22	70	6.61	250
	<b>6665</b>   	Diesel High Base <b>1 5</b> * Seat Height: 22" - 27" Seat: 14" Dia. Overall: 16½"W x 16½"D x 22" - 27"H Finish: Pewter	6665	315.00	315.00	1	17	42	3.81	150
	<b>6666</b>   	Diesel Adjustable-Height <b>1</b> * Seat Height: 23½" - 29½" Seat: 14" Dia. Overall: 17½"Dia. x 29¼"H Finish: Pewter	6666	203.00	203.00	1	16	45	4.34	250
	<b>6668</b>   	Diesel Low Base with Back <b>1 5</b> * Seat Height: 16" - 22" Seat: 14" Dia. Back: 12"W x 7"H Overall: 15"W x 15"D x 30" - 36"H Finish: Pewter	6668	428.00	428.00	1	19	56	5.25	250
	<b>6669</b>   	Diesel Low Base <b>1 5</b> * Seat Height: 16" - 22" Seat: 14" Dia. Overall: 15"W x 15"D x 16" - 22"H Finish: Pewter	6669	279.00	279.00	1	14	28	2.71	150
	<b>Economy Lab Stool</b> <b>1 5</b> * <b>3434BL</b>  	Economy Lab Stool, Black Seat Height: 16" - 21" Seat: 13½" Dia. Base: 18" Dia. <b>Optional Accessories:</b> 5132 Hard Floor Casters and 5138 2" Nylon Glides, see Page 85	3434BL	251.00	251.00	1	13	14	1.22	925
	<b>Extended-Height Lab Stool</b> <b>3436BL</b>  	Extended-Height Lab Stool-Pneumatic, Black Seat Height: 22" - 32" Seat: 13½" Dia. Overall: 18"Dia. x 22" - 32"H	3436BL	254.00	254.00	1	18	28	2.52	125

\*See page 51 for Chair Features and Chair Functions.

# Stools



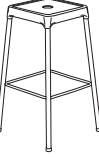









Safco® Products marketing materials are designed to be used as sales tools for our Dealer network.

Model #	Description	Fabric Grades/ Model #	List Price Ea.	List Carton Price	Quantity Per Carton	Actual Weight	S-Parcel Billable Weight	Carton Cube	Freight Class
	<b>Lab Stool</b> <b>3430BL</b> Lab Stool-Pneumatic with Back, Black <b>1 2 3 5 *</b> Seat Height: 17" - 22" Seat: 16" Dia. x 3 1/2" H Overall: 23" Dia. x 30 1/2" - 35 1/2" H <b>Optional Accessories:</b> 5132 Hard Floor Casters and 5138 2" Nylon Glides, see Page 85	3430BL	687.00	687.00	1	26	39	3.62	125
	<b>3431BL</b> Lab Stool-Pneumatic No Back, Black <b>1 5 *</b> Seat Height: 17" - 22" Seat: 16" Dia. x 3 1/2" H Overall: 23" Dia. x 17" - 22" H <b>Optional Accessories:</b> 5132 Hard Floor Casters and 5138 2" Nylon Glides, see Page 85	3431BL	511.00	511.00	1	17	33	2.92	150
	<b>3432BL</b> Lab Stool-Manual Low Base, Black <b>1 5 *</b> Seat Height: 17" - 25" Seat: 16" Dia. x 3 1/2" H Overall: 23" Dia. x 17" - 25" H <b>Optional Accessories:</b> 5132 Hard Floor Casters and 5138 2" Nylon Glides, see Page 85	3432BL	511.00	511.00	1	20	40	3.71	150
	<b>3433BL</b> Lab Stool-Manual High Base, Black <b>1 5 *</b> Seat Height: 25" - 33" Seat: 16" Dia. x 3 1/2" H Overall: 25" Dia. x 25" - 33" H <b>Optional Accessories:</b> 5132 Hard Floor Casters and 5138 2" Nylon Glides, see Page 85	3433BL	511.00	511.00	1	22	55	5.09	150
	<b>3437BL</b> Lab Stool, Low Height Foot Pedal Plate Pneumatic Height Adjustment Seat Height: 17" - 22" Seat: 24 1/4" W x 24 1/4" D x 17" - 22" H	3437BL	333.00	333.00	1	17.2	29	2.81	125
	<b>3438BL</b> Lab Stool, Saddle Seat, Med Height Foot Pedal Plate Pneumatic Height Adjustment Seat Height: 21" - 27" Seat: 24 1/4" W x 24 1/4" D x 21" - 27" H	3438BL	457.00	457.00	1	21.8	43	4.11	125
	<b>Lab Stool Seating Optional Accessories</b>								
	<b>5132</b> Hard Floor Casters	5132	121.00	121.00	Set/5	1	1	0.06	65
	<b>5138</b> 2" Nylon Glides	5138	54.00	54.00	Set/5	1	1	0.03	65
	<b>6660</b> SitStar™ Chrome Base Stool with Adjustable Footring Seat Height: 22" - 32" Seat: 19" W x 14" D Base: 26" Dia. <b>Finish:</b> Black-BL <b>Optional Accessories:</b> 5132 Hard Floor Casters and 5138 2" Nylon Glides, see Page 85	6660BL	624.00	624.00	1	31	38	3.6	100
	<b>6661</b> SitStar™ Back Optional Back Pad Only: 16" W x 19" H <b>Finish:</b> Black-BL	6661BL	317.00	317.00	1	9	23	2.14	100
<b>Steel Stools</b>									
	<b>6603</b> Guest-Height Steel Stool Seat Height: 15" Seat: 13" W x 13" D Overall: 15 1/4" W x 15 1/4" D x 15" H <b>Finish:</b> Black-BL, Blue-BU, Red-RD, Silver-SL, White-WH	6603BL 6603BU 6603RD 6603SL 6603WH	142.00	142.00	1	10	10	0.68	85
	<b>6604</b> Guest-Height Steel Stool Seat Height: 18" Seat: 13" W x 13" D Overall: 15 1/4" W x 15 1/4" D x 18" H <b>Finish:</b> Black-BL, Blue-BU, Red-RD, Silver-SL, White-WH	6604BL 6604BU 6604RD 6604SL 6604WH	142.00	142.00	1	10	10	0.68	85
	<b>6605</b> Counter-Height Steel Stool Seat Height: 25" Seat: 13" W x 13" D Overall: 17 1/4" W x 17 1/4" D x 25" H <b>Finish:</b> Black-BL, Blue-BU, Red-RD, Silver-SL, White-WH	6605BL 6605BU 6605RD 6605SL 6605WH	165.00	165.00	1	11	12	0.95	85
	<b>6606</b> Bar-Height Steel Stool Seat Height: 29" Seat: 13" W x 13" D Overall: 17 1/4" W x 17 1/4" D x 29" H <b>Finish:</b> Black-BL, Blue-BU, Red-RD, Silver-SL, White-WH	6606BL 6606BU 6606RD 6606SL 6606WH	182.00	182.00	1	12	13	1.11	925

\*See page 51 for Chair Features and Chair Functions.



Office Suites  
Seating  
Tables & Desks  
Meeting Essentials  
Personal Organization  
Ergonomics  
High Density Storage  
Storage & Filing  
Facilities  
Technology Furniture  
Art & Engineering  
K-12 Education  
SAFE Collection Addendum

Model #	Description	Fabric Grades/ Model #	List Price Ea.	List Carton Price	Quantity Per Carton	Actual Weight	S-Parcel Billable Weight	Carton Cube	Freight Class
<b>Soft Tough™ Workbench Seating</b>									
	<b>6912</b> Soft Tough™ Stool with Articulating Seat/Back <b>1 2 3 5 14</b> * Seat Height: 22" - 32" Seat: 18"W x 16½"D Back: 17"W x 12"H		872.00	872.00	1	41	43	3.99	925
	<b>6680</b> Economy Workbench Height Chair, Black <b>1 2 3 5</b> * Seat Height: 22" - 32" Seat: 18"W x 16½"D Back: 17"W x 12"H		685.00	685.00	1	39	51	4.63	100
<b>Task Master® Industrial Seating</b>									
	<b>5117</b> Task Master® Economy Industrial Chair <b>1 2 3 5</b> * Seat Height: 17" - 35" Seat: 16¼"W x 16¼"D Back: 14½"W x 9"H		897.00	897.00	1	38	57	5.12	125
	<b>5120</b> Task Master® Deluxe Industrial Chair <b>1 2 5 13 15</b> * Seat Height: 17" - 35" Seat: 18¼"W x 17"D Back: 15¼"W x 12"H		1,313.00	1,313.00	1	49	57	5.21	100
<b>Accessories</b> 									
	<b>5130</b> Tubular Base Inserts (Task Master Only)	5130	53.00	53.00	Set/5	1	1	0.01	100
	<b>5131</b> 2" Carpet Casters (Task Master Only)	5131	90.00	90.00	Set/5	1	1	0.05	65
	<b>5132</b> 2" Hard Floor Casters	5132	121.00	121.00	Set/5	1	1	0.06	65
	<b>5138</b> 2" Nylon Glides	5138	54.00	54.00	Set/5	1	1	0.03	65
	<b>5143</b> Closed Loop Armrests	5143	325.00	325.00	1 Set	8	9	0.74	100
	<b>5144</b> T-Pad Armrests	5144	444.00	444.00	1 Set	7	8	0.51	100
<b>WorkFit™ Polyurethane Seating</b>									
	<b>6950BL</b> WorkFit™ Stool, Chrome Base, Black <b>1 2 3 5</b> * Seat Height: 22" - 30" Seat: 18"W x 16½"D Back: 17"W x 12"H	6950BL	755.00	755.00	1	37	38	3.06	85
<b>Optional Accessories for WorkFit™</b> 									
	<b>6683</b> Adjustable T-Pad Armrests	6683	246.00	246.00	1 Set	7	8	0.52	100
	<b>5131</b> Carpet Casters	5131	90.00	90.00	Set/5	1	1	0.05	65
	<b>5132</b> Hard Floor Casters	5132	121.00	121.00	Set/5	1	1	0.06	65

\*See page 51 for Chair Features and Chair Functions.

# Active Seating

Safco® Products marketing materials are designed to be used as sales tools for our Dealer network.

Office Suites  
Seating  
Tables & Desks  
Meeting Essentials  
Personal Organization  
Ergonomics  
High Density Storage  
Storage & Filing  
Facilities  
Technology Furniture  
Art & Engineering  
K-12 Education  
SAFE Collection Addendum

Model #	Description	Fabric Grades/ Model #	List Price Ea.	List Carton Price	Quantity Per Carton	Actual Weight	S-Parcel Billable Weight	Carton Cube	Freight Class
<b>Twixt™ Active Seating Chair 1 5 *</b>									
3000	Twixt™ Sitting-Height Stool Seat Height: 17" - 22" Seat Size: 15" Dia. Overall: 15" Dia. x 17" - 22" H <b>Fabric:</b> Black-BL, Blue-BU, Green-GN, Orange-OR, Black Vinyl-BV	3000BL	371.00	371.00	1	16	16	1.54	150
		3000BU 3000GN 3000OR 3000BV							
3000	Twixt™ Series Sitting-Height Stool, Custom Seat Height: 17" - 22" Seat Size: 15" Dia. Overall: 15" Dia. x 17" - 22" H COM Yardage: .75 yds. Bases: Black, Chrome, White	01	39.00	39.00	1	16	16	1.54	150
			Upcharge						
		02	59.00	59.00					
		03	82.00	82.00					
COM	59.00	59.00							
		NC	NC						
<b>Twixt™ Active Seating Chair 1 5 *</b>									
3001	Twixt™ Extended-Height Stool Seat Height: 22" - 31¼" Seat Size: 15½" Dia. Overall: 15½" Dia. x 22" - 31¼" H <b>Fabric:</b> Black-BL, Blue-BU, Green-GN, Orange-OR, Black Vinyl-BV	3001BL	408.00	408.00	1	17	19	1.76	150
		3001BU 3001GN 3001OR 3001BV							
3001	Twixt™ Series Extended-Height Stool, Custom Seat Height: 22" - 31¼" Seat Size: 15½" Dia. Overall: 15½" Dia. x 22" - 31¼" H COM Yardage: .75 yds. Bases: Black, Chrome, White	01	39.00	39.00	1	17	19	1.76	150
			Upcharge						
		02	59.00	59.00					
		03	82.00	82.00					
COM	59.00	59.00							
		NC	NC						
<b>Twixt™ Mid-Height Saddle Stool</b>									
3005BV	Twixt™ Mid-Height Saddle Stool Seat Height: 17" - 22" Overall: 15½"W x 15½"D x 17" - 22"H <b>Fabric:</b> Black Vinyl-BV	3005BV	384.00	384.00	1	16.2	17	1.53	150
<b>Twixt™ Extended-Height Saddle Stool</b>									
3006BV	Twixt™ Extended-Height Saddle Stool Seat Height: 22" - 31¼" Overall: 15½"W x 15½"D x 22" - 31¼"H <b>Fabric:</b> Black Vinyl-BV	3006BV	434.00	434.00	1	17.6	21	1.89	150

\*See page 51 for Chair Features and Chair Functions.

Model #	Description	Fabric Grades/Model #	List Price Ea.	List Carton Price	Quantity Per Carton	Actual Weight	S-Parcel Billable Weight	Carton Cube	Freight Class
<b>Runtz™ Ball Chair</b>									
4755	Runtz™ Ball Chair Seat Height: 16-17" Seat Size: 12" Dia. Overall: 22½" Dia. x 16-17"H	4755	350.00	350.00	1	14	21	1.8	125
4756	Runtz™ Ball Chair Vinyl: Black-BV, Blue-BUV, Green-GV, Red-RV  (Legs come with option for 2 height settings)	4756BV 4756BUV 4756GV 4756RV	350.00	350.00	1	14	21	1.83	125
<b>Runtz™ Ball Chair, Vinyl Series</b>									
4757	Runtz™ Ball Chair, Vinyl Series Grade 2 Vinyl, Canter, Dot.com, Hathaway	4757	590.00	590.00	1	14	21	1.83	150
	2 Tone Vinyl  (Legs come with option for 2 height settings)	4757	628.00	628.00					
<b>Runtz™ Swivel Ball Chair</b>									
4761	Runtz™ Swivel Ball Chair Seat Size: 12" Dia. Overall: 22½" Dia. x 17"H	4761BV 4761BUV 4761GV 4761RV	425.00	425.00	1	16.4	24	2.3	100
	Vinyl: Black-BV, Blue-BUV, Green-GV, Red-RV								
<b>Runtz™ Swivel Ball Chair, Vinyl Series</b>									
4761	Runtz™ Swivel Ball Chair, Vinyl Series Grade 2 Vinyl, Canter, Dot.com, Hathaway	4761	620.00	620.00	1	16.4	24	2.33	100
	2 Tone Vinyl	4761	658.00	658.00					
<b>Zenergy™ Ball Chair</b>									
4750	Zenergy™ Ball Chair Seat Height: 22-23" Seat Size: 17½" Dia. Overall: 22½" Dia. x 22-23"H	4750	375.00	375.00	1	15	21	1.8	100
4751	Zenergy™ Ball Chair, Black Vinyl-BV Vinyl: Black-BV, Blue-BUV, Green-GV, Red-RV  (Legs come with option for 2 height settings)	4751BV 4751BUV 4751GV 4751RV	375.00	375.00	1	16	20	1.76	100
<b>Zenergy™ Ball Chair, Vinyl Series</b>									
4753	Zenergy™ Ball Chair, Vinyl Series Grade 1 Vinyl: Dillon, Grade 2 Vinyl: Canter, Canyon, Dot.com, Hathaway Phoenix, Persuasion, Whisper, Vibe	4753	605.00	605.00	1	16	21	1.8	150
	2 Tone Vinyl  (Legs come with option for 2 height settings)	4753	643.00	643.00					
<b>Zenergy™ Swivel Ball Chair</b>									
4760	Zenergy™ Swivel Ball Chair Seat Size: 17½" Dia. Overall: 17½" Dia. x 23"H	4760BL 4760BU 4760GN 4760OR 4760BV	445.00	445.00	1	16	22	2.06	85
	Fabric: Black-BL, Blue-BU, Green-GN, Orange-OR Vinyl: Black-BV, Blue-BUV, Green-GV, Red-RV								
<b>Zenergy™ Swivel Ball Chair, Vinyl Series</b>									
4760	Zenergy™ Swivel Ball Chair, Vinyl Series Grade 1 Vinyl: Dillon, Grade 2 Vinyl: Canter, Canyon, Dot.com, Hathaway Phoenix, Persuasion, Whisper, Vibe	4760	640.00	640.00	1	16	22	2.06	85
	2 Tone Vinyl	4760	679.00	679.00					
<b>Replacement Inner Ball and Plug:</b>									
220000075	Zenergy Inner Ball and Plug	220000075	51.00						
220000076	Runtz Inner Ball and Plug	220000076	51.00						

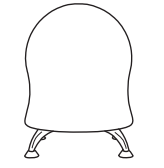
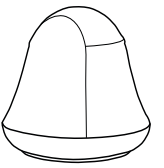
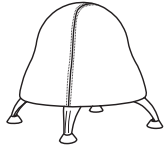

Designed by Thomas Walser.

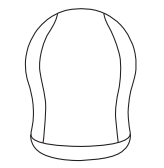

Designed by Thomas Walser.

Office Suites  
Seating  
Tables & Desks  
Meeting Essentials  
Personal Organization  
Ergonomics  
High Density Storage  
Storage & Filing  
Facilities  
Technology Furniture  
Art & Engineering  
K-12 Education  
SAFE Collection Addendum

# Customer's Specified Laminate Request Form

All requests for customization of product, sizes and finishes must have prior approval.

Please email [specials@safcoproducts.com](mailto:specials@safcoproducts.com)

Dealer Name \_\_\_\_\_

Dealer Address \_\_\_\_\_

City, State, Zip \_\_\_\_\_

Safco Sales Representative \_\_\_\_\_

Project Name \_\_\_\_\_

Expected Time Line \_\_\_\_\_

Install Date \_\_\_\_\_

Is this a standards program Yes or NO If Yes, Length of Standards \_\_\_\_\_

Laminate/Paint Manufacturer \_\_\_\_\_

Laminate or Paint Manufacturer Phone Number ( ) \_\_\_\_\_

Laminate or Paint Name \_\_\_\_\_

Laminate or Paint Number \_\_\_\_\_

Safco Model/Series Number \_\_\_\_\_

Quantity \_\_\_\_\_

Is there a desired top and bottom to the laminate application? Yes \_\_\_ No \_\_\_

If yes, clearly specify how laminate is to be applied

**Please Note:**

- Due to standard laminate sheet sizes, most laminates will need to be applied in a horizontal orientation.
- Limited Lifetime Warranty does not extend to Customer Custom Options
- All Custom Options must be approved by Safco's Specials Department before Purchase Order submission

We require 3 sample chips mailed for all color matches along with form to:

Safco Products Company  
 9300 West Research Center Road  
 New Hope, MN 55428

**Attn: Specials**

Office Suites  
 Seating  
 Tables & Desks  
 Meeting Essentials  
 Personal Organization  
 Ergonomics  
 High Density Storage  
 Storage & Filing  
 Facilities  
 Technology Furniture  
 Art & Engineering  
 K-12 Education  
 SAFE Collection Addendum



- A cohesive collection allowing specifiers to achieve a similar look throughout a space
- 1-1/8" thick tops with matching 3mm edge banding
- Tables available in Flip, T-Leg, Post-Leg, Café, Bistro, and Conference
- Textured SILVER powder coat bases
- Flip tables feature dual-sided levers for a quick flip of the top
- Flip tables nest for compact storage
- Sitting-height tables are 29"H
- Bisto café tables are 42"H
- Caster options include 4 locking casters
- Glide options are adjustable
- Manufactured cutouts and power option available

## Cutout Options

### "E" - \$30 List upcharge

(1) Manufactured rectangular cutout 6-7/8 x 3" or surface mount and daisy chain electrical kits.

See page 91 for available power options.

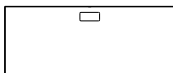

Cutout-E

### "G" - \$30 List upcharge

(1) Manufactured round cutout 1-3/4" diameter located in center.

See page 91 for available power options.

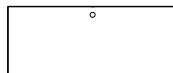

Cutout-G

### "M" - \$60 List upcharge

(2) Manufactured round cutouts 1-3/4" diameter located both right and left.

See page 91 for available power options.

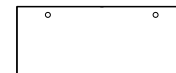

Cutout-M

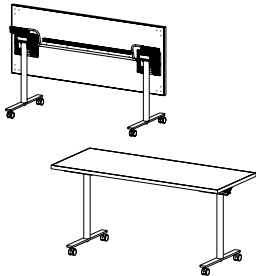

Table with Flip Base\*\*

Model No.	Size (WxD)	(FLP) Flip Base List Price
<b>JN4818</b>	48" x 18"	1,259.00
<b>JN4824</b>	48" x 24"	1,291.00
<b>JN4830</b>	48" x 30"	1,371.00
<b>JN5418</b>	54" x 18"	1,279.00
<b>JN5424</b>	54" x 24"	1,315.00
<b>JN5430</b>	54" x 30"	1,409.00
<b>JN6018</b>	60" x 18"	1,358.00
<b>JN6024*</b>	60" x 24"	1,395.00
<b>JN6030</b>	60" x 30"	1,507.00
<b>JN6618</b>	66" x 18"	1,399.00
<b>JN6624</b>	66" x 24"	1,435.00
<b>JN6630</b>	66" x 30"	1,522.00
<b>JN7218</b>	72" x 18"	1,450.00
<b>JN7224*</b>	72" x 24"	1,495.00
<b>JN7230</b>	72" x 30"	1,604.00

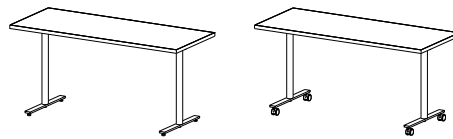

Table with T-Leg Base

Model No.	Size (WxD)	(FXTGL) T-Leg w/Glides List Price	(FXTCA) T-Leg w/Casters List Price
<b>JN4818</b>	48" x 18"	893.00	968.00
<b>JN4824</b>	48" x 24"	925.00	1,000.00
<b>JN4830</b>	48" x 30"	1,005.00	1,080.00
<b>JN5418</b>	54" x 18"	913.00	988.00
<b>JN5424</b>	54" x 24"	949.00	1,024.00
<b>JN5430</b>	54" x 30"	1,043.00	1,118.00
<b>JN6018</b>	60" x 18"	982.00	1,057.00
<b>JN6024*</b>	60" x 24"	1,019.00	1,094.00
<b>JN6030</b>	60" x 30"	1,131.00	1,206.00
<b>JN6618</b>	66" x 18"	1,023.00	1,098.00
<b>JN6624</b>	66" x 24"	1,059.00	1,134.00
<b>JN6630</b>	66" x 30"	1,146.00	1,221.00
<b>JN7218</b>	72" x 18"	1,043.00	1,118.00
<b>JN7224*</b>	72" x 24"	1,088.00	1,163.00
<b>JN7230</b>	72" x 30"	1,197.00	1,272.00

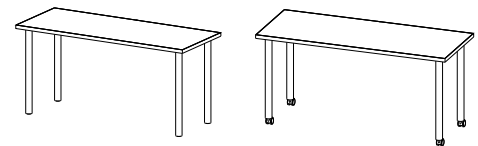

Table with Post-Leg Base

Model No.	Size (WxD)	(FXPGL) Post-Leg w/Glides List Price	(FXPCA) Post-Leg w/Casters List Price
<b>JN4818</b>	48" x 18"	785.00	863.00
<b>JN4824</b>	48" x 24"	817.00	895.00
<b>JN4830</b>	48" x 30"	897.00	975.00
<b>JN5418</b>	54" x 18"	805.00	883.00
<b>JN5424</b>	54" x 24"	841.00	919.00
<b>JN5430</b>	54" x 30"	935.00	1,013.00
<b>JN6018</b>	60" x 18"	874.00	952.00
<b>JN6024*</b>	60" x 24"	911.00	989.00
<b>JN6030</b>	60" x 30"	1,023.00	1,101.00
<b>JN6618</b>	66" x 18"	915.00	993.00
<b>JN6624</b>	66" x 24"	951.00	1,029.00
<b>JN6630</b>	66" x 30"	1,038.00	1,116.00
<b>JN7218</b>	72" x 18"	935.00	1,013.00
<b>JN7224*</b>	72" x 24"	980.00	1,058.00
<b>JN7230</b>	72" x 30"	1,089.00	1,167.00

PLEASE CHOOSE OPTIONS FROM BELOW:

Model	Cutout	Base Style	Foot Option	Standard HPL Laminates
	N - None E - Rectangular Cutout G - Center Cutout M - Left/Right Cutouts	FLP - Flip** FXT - T-Leg FXP - Post-Leg	GL - Glides CA - Casters	ASNT = Asian Night Top and Edge CLWN = Columbian Walnut Top and Edge DSWT = Designer White Top and Edge FUMP = Fusion Maple Top and Edge
Example: JN6024+	N +	FLP +	CA +	DSWT

\*48 hour quickship available

\*\*Flip table available with casters only

# JURNI Café and Conference Tables

Safco® Products marketing materials are designed to be used as sales tools for our Dealer network.

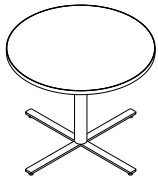

## Café Tables NEW

Model No.	Size and Shape	29"H X-Base List Price	42"H X-Base List Price	29"H Disc-Base List Price	42"H Disc-Base List Price
<b>JN36RD*</b>	36" Round	1,037.00*	1,087.00*	1,095.00	1,145.00
<b>JN42RD*</b>	42" Round	1,141.00*	1,191.00*	1,304.00	1,354.00
<b>JN36SQ</b>	36" Square	1,037.00	1,087.00	1,095.00	1,145.00
<b>JN42SQ</b>	42" Square	1,141.00	1,191.00	1,304.00	1,354.00

PLEASE CHOOSE OPTIONS FROM BELOW:

Model	Cutout	Base Style	Table Height	Standard HPL Laminates
	N - None	DSC - Disc Base XBA - X-Base	29 - 29" Sitting 42 - 42" Bistro	ASNT = Asian Night Top and Edge CLWN = Columbian Walnut Top and Edge DSWT = Designer White Top and Edge FUMP = Fusion Maple Top and Edge
<b>Example:</b> JN36RD+	<u>  </u> N <u>  </u> +	<u>  </u> X <u>  </u> B <u>  </u> A <u>  </u> +	<u>  </u> 4 <u>  </u> 2 <u>  </u> +	<u>  </u> D <u>  </u> S <u>  </u> W <u>  </u> T

\*48 hour quickship available

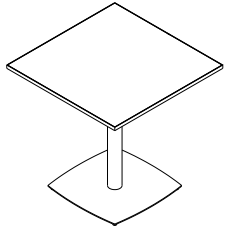

## Conference Tables NEW

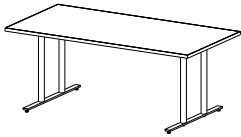

Model No.	Size (WxD)	List Price
<b>JN7236</b>	72" x 36"	1,614.00
<b>JN8442</b>	84" x 42"	1,794.00
<b>JN9642</b>	96" x 42"	2,392.00

PLEASE CHOOSE OPTIONS FROM BELOW:

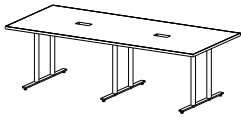



Model	Cutout	Base Style	Foot Option	Standard HPL Laminates
	N - None E - Rectangular	CNF - Conference	GL - Glides	ASNT = Asian Night Top and Edge CLWN = Columbian Walnut Top and Edge DSWT = Designer White Top and Edge FUMP = Fusion Maple Top and Edge
<b>Example:</b> JN8442+	<u>  </u> N <u>  </u> +	<u>  </u> C <u>  </u> N <u>  </u> F <u>  </u> +	<u>  </u> G <u>  </u> L <u>  </u> +	<u>  </u> D <u>  </u> S <u>  </u> W <u>  </u> T

## JURNI Accessories

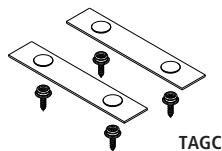
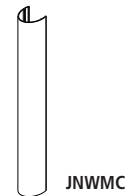
Model #	Description	Model #	List Price Ea.	List Carton Price	Quantity Per Carton	Actual Weight	S-Parcel Billable Weight	Carton Cube	Freight Class
<b>Universal Table Hooks</b>									
<b>2254BL</b>	Table Hook - 6 Pack 	2254BL	93.00	93.00	6	1.4	2	0.04	70
<b>2255BL</b>	Table Hook - 24 Pack 	2255BL	259.00	259.00	24	6	6	0.13	70

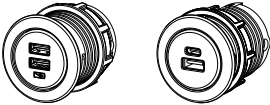
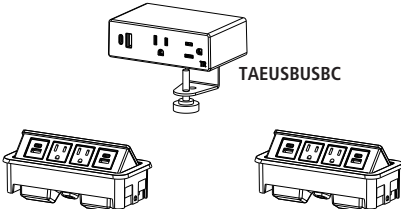
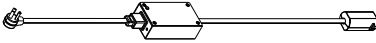

Model #	Description	List Price
<b>JNWMC</b> <span style="background-color: black; color: white; border-radius: 50%; padding: 2px;">NEW</span>	JURNI Wire Management Cover Finish: Silver	75.00
<b>TAGC</b> <span style="background-color: black; color: white; border-radius: 50%; padding: 2px;">NEW</span>	JURNI Ganging Connectors 5 sets	120.00

	Model #	Description	Color	List Price
 <p>F740POW</p>	F740POWB	Single Power Outlet	Black	95.00
	F740POWW	Single Power Outlet	White	95.00
 <p>F740USB      F740USBC</p>	F740USBB	2 USB Ports	Black	295.00
	F740USBW	2 USB Ports	White	295.00
	F740USBCB	1 USB/1 USBC Port	Black	295.00
	F740USBCW	1 USB/1 USBC Port	White	295.00
 <p>TAEUSBUSBC      TAPUSBUSBC      TADUSBUSBC</p>	TAEUSBUSBCB <b>NEW</b>	2-110V, 1USB, 1USBC, Clamp Mount	Black	370.00
	TAEUSBUSBCW <b>NEW</b>	2-110V, 1USB, 1USBC, Clamp Mount	White	370.00
	TAPUSBUSBCB <b>NEW</b>	2-110V, 2USB, 2USBC, Wall plug-In	Black	585.00
	TAPUSBUSBCW <b>NEW</b>	2-110V, 2USB, 2USBC, Wall Plug-In	White	585.00
	TADUSBUSBCB <b>NEW</b>	2-110V, 2USB, 2USBC, Daisy Chain, 60"	Black	598.00
	TADUSBUSBCW <b>NEW</b>	2-110V, 2USB, 2USBC, Daisy Chain, 60"	White	598.00
	TAPDCI <b>NEW</b>	Daisy Chain Link (Required to start chain)	-	645.00
	TADEXT <b>NEW</b>	Daisy Chain Extension, 12"	-	90.00

Office Suites  
Seating  
Tables & Desks  
Meeting Essentials  
Personal Organization  
Ergonomics  
High Density Storage  
Storage & Filing  
Facilities  
Technology Furniture  
Art & Engineering  
K-12 Education  
SAFE Collection Addendum

# Flip-N-Go® Conference/Training Tables

Safco® Products marketing materials are designed to be used as sales tools for our Dealer network.

- Minimal assembly required
- Dual-sided levers for a quick flip of the top
- Tables nest for compact storage
- Integrated Modesty Panel with built-in cable trough
- Tables can be connected together by using ganging kit (included)
- Tables are shipped in two boxes, top and base separately
- Overall HPL table height: 29"
- Four locking casters
- 5¼" between tables when nested
- 150 lb. weight capacity, Evenly distributed
- Base available in Black or Silver Finishes
- Tables available in either Thermally Fused Laminate (TFL) with standard T-Mold or High Pressure Laminate (HPL) with your choice of 3 edge treatments
- HPL Edge Treatments: 3mm (H3), Knife-Edge (HK) or Standard T-Mold (HT) available in corporate edge colors
- See page 10 for corporate laminate color options or go to Safco website
- Manufactured cutouts (5¼ x 3") for daisy chain electrical kits available on 24"D rectangular tables (one centered cutout per table grommet not included)
- Add "E" suffix and \$30 list upcharge per cutout
- Power Options page 112 for surface mount kits

## How to Specify

Start with base model number and **SELECT ONE CODE FROM EACH OF THE OPTIONS** to complete your final model number for ordering:

Select MODEL NUMBER (ie., LF2448)	Step 1: Select [✦] CUTOUT (OPTIONAL)	Step 2: Select [■] LAMINATE/EDGE TYPE
	E = Rectangular (Cutout Only) (Add \$34 List)	H3 = HPL Laminate /3mm Edge
	G = Center Grommet (Add \$30 List)	HK = HPL Laminate /Knife Edge HT = HPL Laminate /T-Mold Edge
	M = Left/Right (2) Grommets (Add \$60 List)	T = TFL Laminate /T-Mold Edge

Add codes to indicate your selections: **E** (Rectangular Cutout Only) **H3** (HPL Laminate /3mm Edge)

The final Model Number for Base Product LF2448 with the highlighted selections would be **LF2448-E-H3** (or **LF2448EH3**).

### • See next page for Cutout and Laminate/Edge options

Note: All non-standard cutouts (other than above) will be reviewed to determine if the cutout does not interfere with the base, degrade table strength or cause imbalance. Contact [specials@safcoproducts.com](mailto:specials@safcoproducts.com) for quote request and drawing signoff will be required before order is processed.

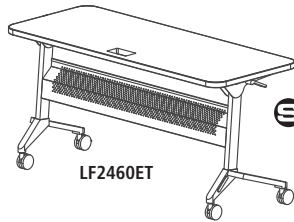

### Rectangular Surfaces

Model No.	Description	Wt.	Available Cutouts	TFL List Price "T" Suffix	HPL List Price HT, HK or H3 Suffix
LF1848	48 x 18" Rectangular	66	G	901.00	960.00
LF1860	60 x 18" Rectangular	76	G,M	960.00	1,064.00
LF1872	72 x 18" Rectangular	86	G,M	1,024.00	1,124.00
LF2448	48 x 24" Rectangular	76	E,G	960.00	1,064.00
LF2460	60 x 24" Rectangular	86	E,G,M	1,064.00	1,166.00
LF2472	72 x 24" Rectangular	96	E,G,M	1,124.00	1,248.00

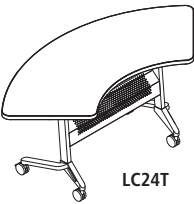

### Crescent Surfaces (48" Radius)

LC24	67 x 24" Crescent	76	-	1,147.00	1,248.00
------	-------------------	----	---	----------	----------

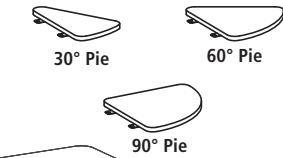

### Trapezoid Surfaces

LP24	60 x 24" Trapezoid	76	-	1,024.00	1,107.00
------	--------------------	----	---	----------	----------

### Pie Connectors

P3018	18" x 30° Pie	4	-	348.00	390.00
P6018	18" x 60° Pie	8	-	365.00	—
P9018	18" x 90° Pie	12	-	390.00	431.00
P3024	24" x 30° Pie	6	-	348.00	390.00
P6024	24" x 60° Pie	12	-	365.00	407.00
P9024	24" x 90° Pie	18	-	390.00	431.00

### Transition Tables (Surfaces can be installed in either direction)

LT24	48"W x 24"D	76	-	1,148.00	1,248.00
------	-------------	----	---	----------	----------

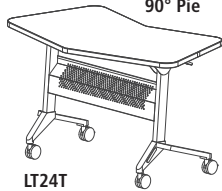

## Flip-N-Go® Conference/Training Tables - Quick Ship Options

- Low pressure laminate tabletop with Black T-mold edge band
- Laminate top options: Regal Mahogany (RMH), Folkstone (FLK4), Cherry (LCRM), Mocha (LDCM)
- Black (S) or Silver (SLV) base to match workspace décor

Example of ordering Quick Ship Model Number for Black (S) Base Product LF2448T with the selected laminate color would be **LF2448T-S-FLK4** (or **LF2448TSFLK4**).

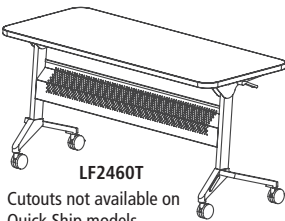

### Rectangular Surfaces

Model No.	Description	Wt.	List Price
LF1848T	48 x 18" Rectangular	66	876.00
LF1860T	60 x 18" Rectangular	76	960.00
LF1872T	72 x 18" Rectangular	86	1,024.00
LF2448T	48 x 24" Rectangular	76	960.00
LF2460T	60 x 24" Rectangular	86	1,064.00
LF2472T	72 x 24" Rectangular	96	1,124.00

Cutouts not available on Quick Ship models

Cutout Options [♣]

"E" - \$30 List upcharge

(1) Manufactured rectangular cutout 5 1/4 x 3" for daisy chain electrical kits only. Grommet caps not included with cutout.

See page 110 for available kit options.

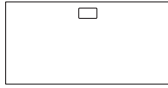

Cutout-E

"G" - \$30 List upcharge

(1) Manufactured round cutout 1 3/4" in diameter located in center approach side of top. Includes grommet cap. Black only.



Cutout-G

"M" - \$60 List upcharge

(2) Manufactured round cutouts 1 3/4" diameter located on right and left approach side of top. Includes (2) grommet caps. Black only.



Cutout-M

Laminate Edge Type [■]

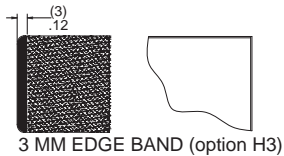

3 MM EDGE BAND (option H3)

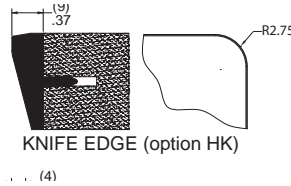

KNIFE EDGE (option HK)

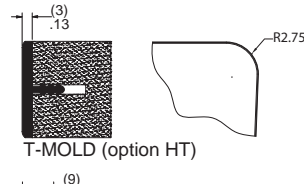

T-MOLD (option HT)

Note: All non-standard cutouts (other than above) will be reviewed to determine if the cutout does not interfere with the base, degrade table strength or cause imbalance. Contact [specials@safcoproducts.com](mailto:specials@safcoproducts.com) for quote request and drawing signoff will be required before order is processed.

Flip-N-Go® Conference/Training Tables - Idea Starters

• Must order by individual model numbers.

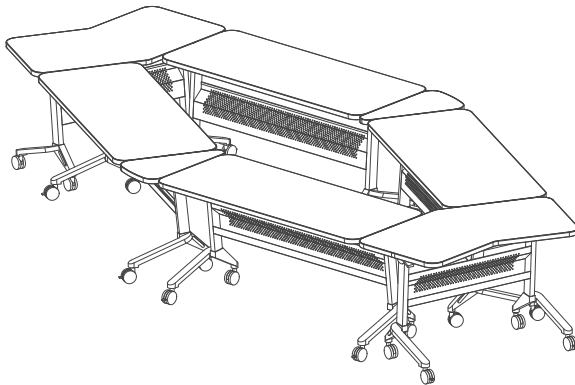

Flip-N-Go Idea Starter #1

Consists of:

Qty.	Model No.	Description	List Price Each
4	LF2460T	Rectangular Table, 24 x 60"	1,064.00
2	LT24T	24"D Transition Table	1,148.00
2	P3024T	24" x 30° Pie	348.00

Total: 7,248.00

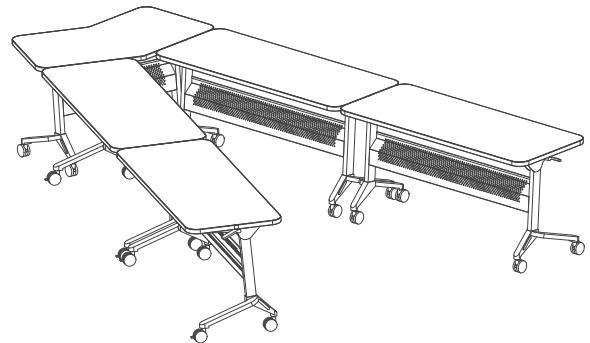

Flip-N-Go Idea Starter #2

Consists of:

Qty.	Model No.	Description	List Price Each
4	LF2460T	Rectangular Table, 24 x 60"	1,064.00
1	LT24T	24"D Transition Table	1,148.00

Total: 5,404.00

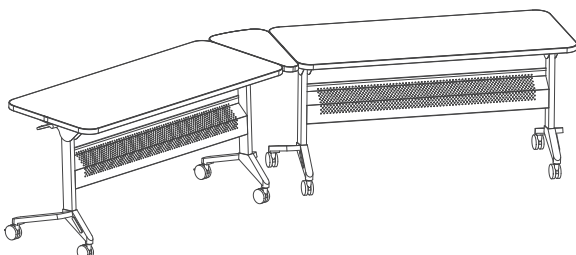

Flip-N-Go Idea Starter #3

Consists of:

Qty.	Model No.	Description	List Price Each
2	LF2460T	Rectangular Table, 24 x 60"	1,064.00
1	P3024T	24" x 30° Pie	348.00

Total: 2,476.00

- Single-handed center control mechanism for convenient flip of the top
- Minimal assembly required, installs in minutes
- Tables straight-row nest for compact storage
- Integrated modesty panel with built-in cable trough
- Tables can be connected together by using ganging kit (included)
- Overall table height: 29½", four 3" locking casters
- 150 lb. weight capacity, evenly distributed
- Tables available with Silver frame, and tops in either Thermally Fused Laminate (TFL) with standard T-Mold or High Pressure Laminate (HPL) with your choice of (3) edge treatments
- See page 10 for laminate color options or go to Safco website
- HPL Edge Treatments: 3mm (H3), Knife-Edge (HK) or Standard T-Mold (HT) available in corporate edge colors, see page 10
- Manufactured cutouts (5¼ x 3") for daisy chain electrical kits available on 30"D rectangular tables (one centered cutout per table, Grommet not included), add "E" suffix and \$30 list upcharge per cutout
- See Training Tables Power Options pg 110 for surface mount kits
- Silver Base only
- Tables are shipped in two boxes
- 6½" between tables when nested

## How to Specify

Start with base model number and **SELECT ONE CODE FROM EACH OF THE OPTIONS** to complete your final model number for ordering:

Select MODEL NUMBER (ie., SY2448)	Step 1: Select [✦] CUTOUT (OPTIONAL)	Step 2: Select [■] LAMINATE/EDGE TYPE
	E = Rectangular (Cutout Only) (Add \$30 List)	H3 = HPL Laminate /3mm Edge
	G = Center Grommet (Add \$30 List)	HK = HPL Laminate /Knife Edge HT = HPL Laminate /T-Mold Edge
	M = Left/Right (2) Grommets (Add \$60 List)	T = TFL Laminate /T-Mold Edge

Add codes to indicate your selections: **E** (Rectangular Cutout Only) **H3** (HPL Laminate /3mm Edge)

The final Model Number for Base Product SY2448 with the highlighted selections would be SY2448-E-H3 (or SY2448EH3).

• See next page for Cutout and Laminate/Edge options

Note: All non-standard cutouts (other than above) will be reviewed to determine if the cutout does not interfere with the base, degrade table strength or cause imbalance. Contact [specials@safcoproducts.com](mailto:specials@safcoproducts.com) for quote request and drawing signoff will be required before order is processed.

## Sync™ Conference/Training Tables

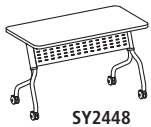

SY2448

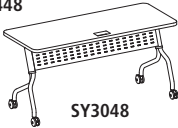

SY3048

Shown with optional manufactured cut-outs for daisy chain electrical kits.

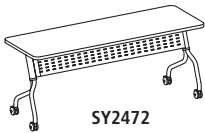

SY2472

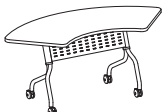

SYC24



SYP24



SYT24



SYT30



30° Pie



60° Pie



90° Pie

### Rectangular Surfaces

Model No.	Description	Wt.	Available Cutouts	TFL List Price "T" Suffix	HPL List Price HT, HK or H3 Suffix
SY1848	48 x 18" Rectangular	66	G	982.00	1,074.00
SY1854	54 x 18" Rectangular	71	G	1,052.00	1,134.00
SY1860	60 x 18" Rectangular	76	G,M	1,074.00	1,187.00
SY1866	66 x 18" Rectangular	80	G,M	1,111.00	1,213.00
SY1872*	72 x 18" Rectangular	86	G,M	1,142.00	1,260.00
SY2448	48 x 24" Rectangular	76	G	1,074.00	1,187.00
SY2454	54 x 24" Rectangular	82	G	1,143.00	1,255.00
SY2460	60 x 24" Rectangular	86	G,M	1,187.00	1,310.00
SY2466*	66 x 24" Rectangular	92	G,M	1,234.00	1,373.00
SY2472*	72 x 24" Rectangular	96	G,M	1,260.00	1,402.00
SY3048	48 x 30" Rectangular	86	E,G	1,168.00	1,310.00
SY3054*	54 x 30" Rectangular	93	E,G	1,224.00	1,368.00
SY3060*	60 x 30" Rectangular	99	E,G,M	1,286.00	1,424.00
SY3066*	66 x 30" Rectangular	105	E,G,M	1,329.00	1,470.00
SY3072*	72 x 30" Rectangular	111	E,G,M	1,373.00	1,515.00

\*Models that do not ship via small parcel

### Crescent Surfaces (48" Radius)

SYC24	67 x 24" Crescent	78	-	1,213.00	1,334.00
-------	-------------------	----	---	----------	----------

### Trapezoid Surfaces

SYP24	60 x 24" Trapezoid	78	-	1,213.00	1,334.00
-------	--------------------	----	---	----------	----------

### Transition Surfaces

SYT24	48"W x 24"D	78	-	1,287.00	1,383.00
SYT30	60"W x 30"D	100	-	1,325.00	1,422.00

### Pie Connectors

P3018	18" x 30° Pie	4	-	348.00	390.00
P6018	18" x 60° Pie	8	-	365.00	—
P9018	18" x 90° Pie	12	-	390.00	431.00
P3024	24" x 30° Pie	6	-	348.00	390.00
P6024	24" x 60° Pie	12	-	365.00	407.00
P9024	24" x 90° Pie	18	-	390.00	431.00
P3030	30" x 30° Pie	8	-	—	390.00
P6030	30" x 60° Pie	16	-	365.00	407.00
P9030	30" x 90° Pie	22	-	390.00	431.00

Cutout Options [♣]

"E" - \$30 List upcharge

(1) Manufactured rectangular cutout 5 1/4 x 3" for daisy chain electrical kits only. Grommet caps not included with cutout.

See page 110 for available kit options.



Cutout-E



Cutout-G



Cutout-M

"G" - \$30 List upcharge

(1) Manufactured round cutout 1 3/4" in diameter located in center approach side of top. Includes grommet cap. Black only.

"M" - \$60 List upcharge

(2) Manufactured round cutouts 1 3/4" diameter located on right and left approach side of top. Includes (2) grommet caps. Black only.

Laminate Edge Type [■]

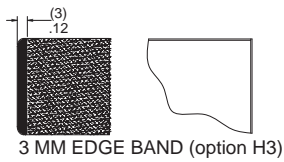

3 MM EDGE BAND (option H3)

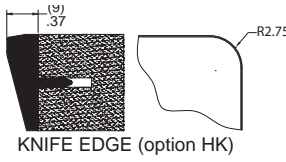

KNIFE EDGE (option HK)

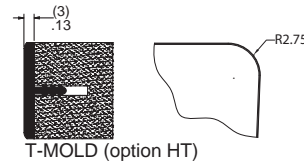

T-MOLD (option HT)

Note: All non-standard cutouts (other than above) will be reviewed to determine if the cutout does not interfere with the base, degrade table strength or cause imbalance. Contact specials@safcoproducts.com for quote request and drawing signoff will be required before order is processed.

Sync™ Conference/Training Tables - Idea Starters

• Must order by individual model numbers.

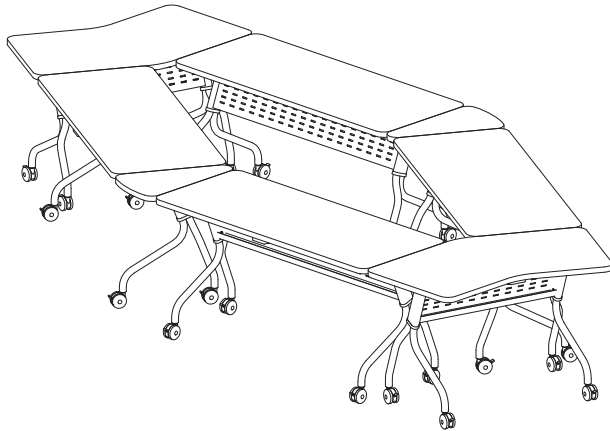

Sync Idea Starter #1

Consists of:

Qty.	Model No.	Description	List Price Each
4	SY2460T	Rectangular Table, 24 x 60"	1,187.00
2	SYT24T	24"D Transition Table	1,287.00
2	P3024T	24" x 30° Pie	348.00

Total: 8,018.00

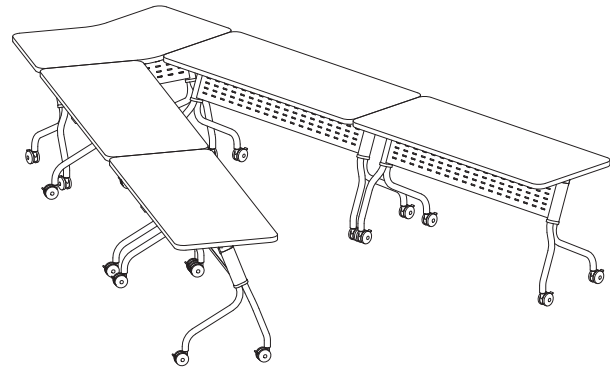

Sync Idea Starter #2

Consists of:

Qty.	Model No.	Description	List Price Each
4	SY2460T	Rectangular Table, 24 x 60"	1,187.00
1	SYT24T	24"D Transition Table	1,287.00

Total: 6,035.00

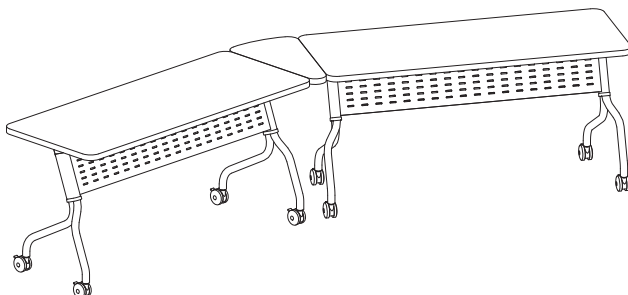

Sync Idea Starter #3

Consists of:

Qty.	Model No.	Description	List Price Each
2	SY2460T	Rectangular Table, 24 x 60"	1,187.00
1	P3024T	24" x 30° Pie	348.00

Total: 2,722.00



## Rumba Nesting Top SKU # Formula



Model	Top Shape	Top Size	Top Color
RBA	REC-Rectangle	7224-72"x24" 6024-60"x24" 4824-48"x24" 7230-72"x30" 6030-60"x30"	BMCHBK-Biltmore Cherry   Black Edge DSWTWI-Designer White   White Edge FNGYWI-Fashion Gray   White Edge ASNTBK-Asian Night   Black Edge CLWNBK-Columbian Walnut   Black Edge FUMPWI-Fusion Maple   White Edge AISAWI-Asian Sand   White Edge BLAKBK-Black   Black Edge
RBA+	REC+	6024+	FNGYWI

Ex: **RBAREC6024FNGYWI** Rumba Rectangular 60x24" Top in Fashion Gray | White Edge Band

## Rumba Nesting Base SKU # Formula

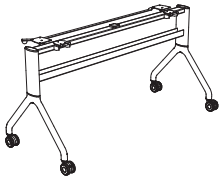

Model	Base Style	Base Size	Base Color
RBA	FL-Flip	7224-72"x24" 6024-60"x24" 4824-48"x24" 7230-72"x30" 6030-60"x30"	SL-Silver BL-Black
RBA+	FL+	6024+	SL











Ex: **RBAFL6024SL** Rumba Flip 60x24" Base in Silver

### Quick Ship Laminate Colors:

BMCHBK – Biltmore Cherry | Black Edge  
DSWTWI – Designer White | White Edge  
FNGYWI – Fashion Gray | White Edge

### Built to Order Laminate Colors:

ASNTBK – Asian Night | Black Edge  
CLWNBK – Columbian Walnut | Black Edge  
FUMPWI – Fusion Maple | White Edge  
AISAWI – Asian Sand | White Edge  
BLAKBK – Black | Black Edge

Model # (Top + Coordinating Base)	Description	Model	List Price Ea.	Number of Cartons	Actual Weight	S-Parcel Billable Weight	Carton Cube	Freight Class
 <b>RBAREC7224</b>  <b>RBAFL7224</b>	Rumba™ Rectangle Top - 72"W x 24"D Rumba™ Base - 29½"H	RBAREC7224 RBAFL7224	610.00 1,005.00	1 1	55.2 54.2	LTL LTL	1.67 4.91	70 92.5
 <b>RBAREC6024</b>  <b>RBAFL6024</b>	Rumba™ Rectangle Top - 60"W x 24"D Rumba™ Base - 29½"H	RBAREC6024 RBAFL6024	508.00 947.00	1 1	48 47.6	LTL LTL	1.38 4.2	60 92.5
 <b>RBAREC4824</b>  <b>RBAFL4824</b>	Rumba™ Rectangle Top - 48"W x 24"D Rumba™ Base - 29½"H	RBAREC4824 RBAFL4824	407.00 875.00	1 1	32.6 41	LTL LTL	1.12 3.01	62 85
 <b>RBAREC7230</b>  <b>RBAFL7230</b>	Rumba™ Rectangle Top - 72"W x 30"D Rumba™ Base - 29½"H	RBAREC7230 RBAFL7230	762.00 1,063.00	1 1	66.4 53.8	LTL LTL	2.04 5.04	60 92.5
 <b>RBAREC6030</b>  <b>RBAFL6030</b>	Rumba™ Rectangle Top - 60"W x 30"D Rumba™ Base - 29½"H	RBAREC6030 RBAFL6030	636.00 1,005.00	1 1	56 49.2	LTL LTL	1.72 4.2	60 92.5

### Quick Ship Kits



- High pressure laminate tabletop with 3mm edge band
- Laminate top options: Designer White (DSWT) with white edge band, Fashion Gray (FNGY) with white edge band, and Biltmore Cherry (BMCH) with black edge band
- Silver (SL) bases only for Quick Ship SKUs
- Example: **RBA7230FL-SL-DSWT** (or **RBA7230FLSLDSWT**) Rumba 72 x 30" Flip base in Silver (SL) with Designer White (DSWT) top



<b>RBA7224FL</b>	Rumba™ Rectangle Top - 72"W x 24"D, Flip Table	RBA7224FL	1,470.00	2	103	LTL	8.8	85
<b>RBA6024FL</b>	Rumba™ Rectangle Top - 60"W x 24"D, Flip Table	RBA6024FL	1,323.00	2	88	LTL	7.38	85
<b>RBA4824FL</b>	Rumba™ Rectangle Top - 48"W x 24"D, Flip Table	RBA4824FL	1,180.00	2	74	LTL	5.96	70
<b>RBA7230FL</b>	Rumba™ Rectangle Top - 72"W x 30"D, Flip Table	RBA7230FL	1,645.00	2	113	LTL	10.95	70
<b>RBA6030FL</b>	Rumba™ Rectangle Top - 60"W x 30"D, Flip Table	RBA6030FL	1,453.00	2	99	LTL	9.19	70



These products are subject to California Proposition 65. Please visit the product detail page on our website for specific information.

Rumba Fixed Top SKU # Formula

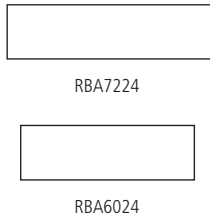

Model	Top Size	Top Color
RBA	7224-72"x24" 6024-60"x24"	BMCHBK-Biltmore Cherry   Black Edge DSWTWI-Designer White   White Edge FNGYWI-Fashion Gray   White Edge ASNTBK-Asian Night   Black Edge CLWNBK-Columbian Walnut   Black Edge FUMPWI-Fusion Maple   White Edge AISAWI-Asian Sand   White Edge BLAKBK-Black   Black Edge
RBA+	7224+	AISAWI

Ex: **RBA7224AISAWI** Rumba 72x24" Top in Asian Sand | White Edge Band

Rumba Fixed Base SKU # Formula

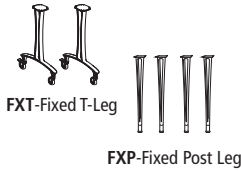

Model	Base Style	Caster or Glide	Base Color
RBA	FXT-Fixed T-Leg FXP-Fixed Post Leg	CA-Caster GL-Glide	SL-Silver BL-Black
RBA+	FXT+	GL+	BL

Ex: **RBAFXTGLBL** Rumba Fixed T-Leg Glide Base in Black



Ex: **RBA7224AISAWI** Rumba 72x24" Top in Asian Sand | White Edge Band

Ex: **RBAFXTGLBL** Rumba Fixed T-Leg Glide Base in Black

Quick Ship Laminate Colors:

BMCHBK – Biltmore Cherry | Black Edge  
DSWTWI – Designer White | White Edge  
FNGYWI – Fashion Gray | White Edge

Built to Order Laminate Colors:

ASNTBK – Asian Night | Black Edge  
CLWNBK – Columbian Walnut | Black Edge  
FUMPWI – Fusion Maple | White Edge  
AISAWI – Asian Sand | White Edge  
BLAKBK – Black | Black Edge

Model # (Top + Coordinating Base)	Description	Model	List Price Ea.	Number of Cartons	Actual Weight	S-Parcel Billable Weight	Carton Cube	Freight Class
<b>RBA7224</b>	Rumba™ Top - 72"W x 24"D	RBA7224	610.00	1	59	LTL	1.71	60
<b>RBA6024</b>	Rumba™ Top - 60"W x 24"D	RBA6024	508.00	1	46	LTL	1.45	60
<b>RBAFXTCA</b>	Rumba™ Fixed T-Leg Caster Base - 29½"H	RBAFXTCA	664.00	1	23.8	LTL	3.44	125
<b>RBAFXTGL</b>	Rumba™ Fixed T-Leg Glide Base - 29½"H	RBAFXTGL	621.00	1	23.2	LTL	3.47	125
<b>Rumba™ T-Leg Accessory</b>								
<b>2086</b>	Rumba™ T-Leg Caps For use with Rumba™ T-Leg Tables Only <b>Finish:</b> Black-BL, Metallic Gray-SL	2086BL 2086SL	84.00	Set	2	3	0.21	100
<b>RBAFXPCA</b>	Rumba™ Fixed Post-Leg Caster Base - 29½"H	RBAFXPCA	579.00	1	17.8	LTL	1.2	85
<b>RBAFXPGL</b>	Rumba™ Fixed Post-Leg Glide Base - 29½"H	RBAFXPGL	545.00	1	17.4	LTL	1.18	85

Quick Ship Kits

- High pressure laminate tabletop with 3mm edge band
- Laminate top options: Designer White (DSWT) with white edge band, Fashion Gray (FNGY) with white edge band, and Biltmore Cherry (BMCH) with black edge band
- Silver (SL) bases only for quick ship SKUs
- **Example:** **RBA7224PG-SL-DSWT** (or **RBA7224PGSLDSWT**) Rumba 72 x 24" Post-legs with glides in Silver (SL) and designer white (DSWT) top

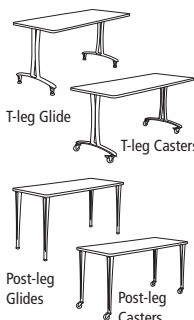

<b>RBA7224TG</b>	Rumba 72x24 T-leg Glide	RBA7224TG	1,120.00	2	76	LTL	11.13	125
<b>RBA7224TCA</b>	Rumba 72x24 T-leg Caster	RBA7224TCA	1,159.00	2	77	LTL	11.13	125
<b>RBA7224PG</b>	Rumba 72x24 Post-leg Glide	RBA7224PG	1,051.00	2	71	LTL	7.71	100
<b>RBA7224PCA</b>	Rumba 72x24 Post-leg Caster	RBA7224PCA	1,081.00	2	71	LTL	7.71	100
<b>RBA6024TG</b>	Rumba 60x24 T-leg Glide	RBA6024TG	999.00	2	69	LTL	9.34	125
<b>RBA6024TCA</b>	Rumba 60x24 T-leg Caster	RBA6024TCA	1,066.00	2	69	LTL	9.34	125
<b>RBA6024PG</b>	Rumba 60x24 Post-leg Glide	RBA6024PG	958.00	2	63	LTL	6.47	100
<b>RBA6024PCA</b>	Rumba 60x24 Post-leg Caster	RBA6024PCA	988.00	2	63	LTL	6.47	100

These products are subject to California Proposition 65. Please visit the product detail page on our website for specific information.

Office Suites  
Seating  
Tables & Desks  
Meeting Essentials  
Personal Organization  
Ergonomics  
High Density Storage  
Storage & Filing  
Facilities  
Technology Furniture  
Art & Engineering  
K-12 Education  
SAFE Collection Addendum



Spark Top SKU # Formula



Model	Top Size	Top Color
SPK	7220-72"x20" 7224-72"x24" 6020-60"x20" 6024-60"x24"	BMCHBK-Biltmore Cherry   Black Edge DSWTWI-Designer White   White Edge FNGYWI-Fashion Gray   White Edge ASNTBK-Asian Night   Black Edge CLWNBK-Columbian Walnut   Black Edge FUMPWI-Fusion Maple   White Edge AISAWI-Asian Sand   White Edge BLAKBK-Black   Black Edge
SPK+	7020+	DSWTWI

Ex: **SPK7020DSWTWI** Spark 70x20" Top in Designer White | White Edge Band

Spark Base SKU # Formula



Model	Base Size	Base Color
SPK	60-60"W 72-72"W	SL-Silver BL-Black
SPK+	72+	SL

Ex: **SPK72SL** Spark 72"W Base in Silver

Quick Ship Laminate Colors:

BMCHBK – Biltmore Cherry | Black Edge  
DSWTWI – Designer White | White Edge  
FNGYWI – Fashion Gray | White Edge

Built to Order Laminate Colors:

ASNTBK – Asian Night | Black Edge  
CLWNBK – Columbian Walnut | Black Edge

FUMPWI – Fusion Maple | White Edge  
AISAWI – Asian Sand | White Edge  
BLAKBK – Black | Black Edge

Model # (Top + Coordinating Base)	Description	Model	List Price Ea.	Number of Cartons	Actual Weight	S-Parcel Billable Weight	Carton Cube	Freight Class
	<b>SPK7220</b> Spark™ Top - 72"W x 20"D	SPK7220	489.00	1	44.4	45	1.41	85
	<b>SPK7224</b> Spark™ Top - 72"W x 24"D	SPK7224	588.00	1	54	LTL	1.65	60
	<b>SPK72</b> Spark™ Base - 42"H	SPK72	386.00	1	35	LTL	4.17	100
	<b>SPK6020</b> Spark™ Top - 60"W x 20"D	SPK6020	428.00	1	36.6	37	1.18	85
	<b>SPK6024</b> Spark™ Top - 60"W x 24"D	SPK6024	512.00	1	45.2	LTL	1.38	60
	<b>SPK60</b> Spark™ Base - 42"H	SPK60	332.00	1	32	LTL	3.04	92.5

Quick Ship Kits

- High pressure laminate tabletop with 3mm edge band
- Laminate top options: Designer White (DSWT) with white edge band, Fashion Gray (FNGY) with white edge band, and Biltmore Cherry (BMCH) with black edge band
- Silver (SL) bases only for quick ship SKUs
- Example: **SPK7224-SL-DSWT** (or **SPK7224SLDSWT**) Spark 72 x 24" silver base (SL) with designer white (DSWT) top

	<b>SPK7220</b> Spark™ - 72"W x 20"D x 42"H	SPK7220	820.00	2	72	LTL	6.93	250
	<b>SPK7224</b> Spark™ - 72"W x 24"D x 42"H	SPK7224	869.00	2	79	LTL	7.90	250
	<b>SPK6020</b> Spark™ 60"W x 20"D x 42"H	SPK6020	692.00	2	63	LTL	5.81	250
	<b>SPK6024</b> Spark™ 60"W x 24"D x 42"H	SPK6024	732.00	2	68	LTL	6.62	250

Oasis™ Teaming Tables

Oasis™ Teaming Tables

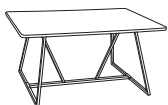

**3019** Oasis™ Teaming Sitting-Height Table  
Overall Size: 60"W x 48"D x 29 1/4"H  
Finish: Cherry-CY, Weathered White-WW

3019CY 943.00 1 123 LTL 12.39 925  
3019WW



**3020** Oasis™ Teaming Standing-Height Table  
Overall Size: 60"W x 48"D x 42"H  
Finish: Cherry-CY, Weathered White-WW

3020CY 1,009.00 1 126 LTL 12.39 925  
3020WW

Office Suites  
Seating  
Tables & Desks  
Meeting Essentials  
Personal Organization  
Ergonomics  
High Density Storage  
Storage & Filing  
Facilities  
Technology Furniture  
Art & Engineering  
K-12 Education  
SAFE Collection Addendum

## Cha-Cha Top SKU # Formula

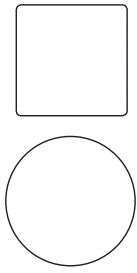

Model	Top Shape	Top Size	Top Color
CHA	SQ-Square RND-Round	30-30" Sq. 36-36" Dia.	<b>BMCHBK</b> -Biltmore Cherry   Black Edge <b>DSWTWI</b> -Designer White   White Edge <b>FNGYWI</b> -Fashion Gray   White Edge <b>ASNTBK</b> -Asian Night   Black Edge <b>CLWNBK</b> -Columbian Walnut   Black Edge <b>FUMPWI</b> -Fusion Maple   White Edge <b>AISAWI</b> -Asian Sand   White Edge <b>BLAKBK</b> -Black   Black Edge
CHA+	RND+	30+	FUMPWI

Ex: **CHARND30FUMPWI** Cha-Cha Round 30" Dia Top in Fusion Maple | White Edge Band

## Cha-Cha Base SKU # Formula

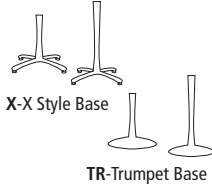

Model	Base Height	Base Style	Base Color
CHA	29-29" H 42-42" H	X-X Style TR-Trumpet	SL-Silver BL-Black
CHA+	29+	TR+	SL

Ex: **CHA29TRSL** Cha-Cha 29" H Trumpet Base in Silver



Ex: **CHARND30FUMPWI** Cha-Cha Round 30" Dia Top in Fusion Maple | White Edge Band

Ex: **CHA29TRSL** Cha-Cha 29" H Trumpet Base in Silver

### Quick Ship Laminate Colors:

BMCHBK – Biltmore Cherry | Black Edge  
 DSWTWI – Designer White | White Edge  
 FNGYWI – Fashion Gray | White Edge

### Built to Order Laminate Colors:

ASNTBK – Asian Night | Black Edge  
 CLWNBK – Columbian Walnut | Black Edge  
 FUMPWI – Fusion Maple | White Edge  
 AISAWI – Asian Sand | White Edge  
 BLAKBK – Black | Black Edge

Model # (Top + Coordinating Base)	Description	Model	List Price Ea.	Number of Cartons	Actual Weight	S-Parcel Billable Weight	Carton Cube	Freight Class
	<b>CHASQ30</b> Cha-Cha™ Square Top - 30" Sq.	CHASQ30	358.00	1	27	27	0.92	70
	<b>CHASQ36</b> Cha-Cha™ Square Top - 36" Sq.	CHASQ36	484.00	1	37	37	1.28	70
	<b>CHARND30</b> Cha-Cha™ Round Top - 30" Dia.	CHARND30	323.00	1	22	LTL	0.92	70
	<b>CHARND36</b> Cha-Cha™ Round Top - 36" Dia.	CHARND36	394.00	1	30	LTL	1.28	70
	<b>CHA29X</b> Cha-Cha™ X-Base - 29" H	CHA29X	511.00	1	17	LTL	2.16	125
	<b>CHA42X</b> Cha-Cha™ X-Base - 42" H	CHA42X	547.00	1	22	LTL	3.57	125
	<b>CHA29TR</b> Cha-Cha™ Trumpet-Base - 29" H	CHA29TR	511.00	1	24	LTL	2.42	100
	<b>CHA42TR</b> Cha-Cha™ Trumpet-Base - 42" H	CHA42TR	547.00	1	30	LTL	3.54	100

### Quick Ship Kits

- High pressure laminate tabletop with 3mm edge band
- Laminate top options: Designer White (DSWT) with white edge band, Fashion Gray (FNGY) with white edge band, and Biltmore Cherry (BMCH) with black edge band
- Silver (SL) bases only for quick ship SKUs
- **Example:** **CHARND3629X-SL-DSWT** (or **CHARND3629XSLDSWT**) Cha-Cha 36 Dia. x 29" silver base (SL) with designer white (DSWT) top

CHARND3029X	ChaCha Round 30" 29" H X-base	CHARND3029X	741.00	2	39	LTL	4.28	125
CHARND3029TR	ChaCha Round 30" 29" H Trumpet-base	CHARND3029TR	741.00	2	46	LTL	4.28	100
CHARND3629X	ChaCha Round 36" 29" H X-base	CHARND3629X	803.00	2	47	LTL	5.97	100
CHARND3629TR	ChaCha Round 36" 29" H Trumpet-base	CHARND3629TR	774.00	2	54	LTL	5.97	125
CHARND3042X	ChaCha Round 30" 42" H X-base	CHARND3042X	765.00	2	44	LTL	4.22	92.5
CHARND3042TR	ChaCha Round 30" 42" H Trumpet-base	CHARND3042TR	765.00	2	52	LTL	4.96	92.5
CHARND3642X	ChaCha Round 36" 42" H X-base	CHARND3642X	828.00	2	52	LTL	5.92	125
CHARND3642TR	ChaCha Round 36" 42" H Trumpet-base	CHARND3642TR	828.00	2	60	LTL	6.12	100
CHASQ3029X	ChaCha Square 30" 29" H X-base	CHASQ3029X	772.00	2	39	LTL	4.28	125
CHASQ3029TR	ChaCha Square 30" 29" H Trumpet-base	CHASQ3029TR	772.00	2	51	LTL	4.28	92.5
CHASQ3629X	ChaCha Square 36" 29" H X-base	CHASQ3629X	867.00	2	54	LTL	5.97	125
CHASQ3629TR	ChaCha Square 36" 29" H Trumpet-base	CHASQ3629TR	867.00	2	61	LTL	5.97	100
CHASQ3042X	ChaCha Square 30" 42" H X-base	CHASQ3042X	796.00	2	49	LTL	4.22	92.5
CHASQ3042TR	ChaCha Square 30" 42" H Trumpet-base	CHASQ3042TR	796.00	2	57	LTL	4.96	92.5
CHASQ3642X	ChaCha Square 36" 42" H X-base	CHASQ3642X	892.00	2	59	LTL	5.92	100
CHASQ3642TR	ChaCha Square 36" 42" H Trumpet-base	CHASQ3642TR	892.00	2	67	LTL	6.12	92.5

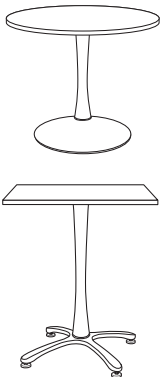

These products are subject to California Proposition 65. Please visit the product detail page on our website for specific information.

Office Suites  
Seating  
Tables & Desks  
Meeting Essentials  
Personal Organization  
Ergonomics  
High Density Storage  
Storage & Filing  
Facilities  
Technology Furniture  
Art & Engineering  
K-12 Education  
SAFE Collection Addendum

- Available in dining (29") or bar (42") heights
- Cast iron base with 3" diameter steel tube support (Black only)
- Quick and easy assembly
- TFL = 1" tops; HPL = 1 1/8" tops
- Optional 18" footring
- Available in either 1" Thermally Fused Laminate (TFL) or 1 1/8" High pressure Laminate (HPL) surfaces
- HPL edge Treatments: Knife Edge (HK), or T-Mold (HT) available in corporate edge colors
- See page 10 for corporate laminate color options or go to Safco website
- **Designer Finishes:** Customer Specified Request form available. See page 11; use "H" suffix on model number when ordering

Bistro Dining-Height Tables

Model No.	Description	Wt.	TFL List Price "T" Suffix	HPL List Price HT or HK Suffix
<b>Dining-Height Models</b>				
Ⓢ CA30SLB	30"W x 30"D x 29"H Square Table	55	711.00	1,107.00
Ⓢ CA30RLB	30"Dia. x 29"H Round Table	50	706.00	1,109.00
Ⓢ CA36SLB	36"W x 36"D x 29"H Square Table	70	807.00	1,279.00
Ⓢ CA36RLB	36"Dia. x 29"H Round Table	60	803.00	1,281.00
CA42RLB	42"Dia. x 29"H Round Table	70	1,109.00	1,401.00
CA2PL	72"W x 30"D x 29"H Peanut Table	75	2,023.00	2,382.00



Bistro Bar-Height Tables

Model No.	Description	Wt.	TFL List Price "T" Suffix	HPL List Price HT or HK Suffix
<b>Bar-Height Models</b>				
Ⓢ CA30SHB	30"W x 30"D x 42"H Square Table	57	729.00	1,134.00
Ⓢ CA30RHB	30"Dia. x 42"H Round Table	52	728.00	1,135.00
Ⓢ CA36SHB	36"W x 36"D x 42"H Square Table	72	825.00	1,303.00
Ⓢ CA36RHB	36"Dia. x 42"H Round Table	62	822.00	1,304.00
CA42RHB	42"Dia. x 42"H Round Table	72	1,135.00	1,423.00
CA2PH	72"W x 30"D x 42"H Peanut Table	80	2,069.00	2,470.00

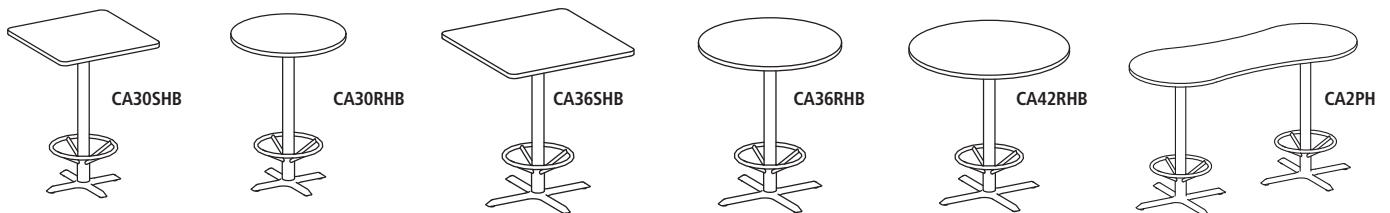

Steel Footring

Model No.	Description	Wt.	List Price
Ⓢ CAFR18B	18" Steel Footring	8	453.00



Office Suites  
Seating  
Tables & Desks  
Meeting Essentials  
Personal Organization  
Ergonomics  
High Density Storage  
Storage & Filing  
Facilities  
Technology Furniture  
Art & Engineering  
K-12 Education  
SAFE Collection Addendum



# Bistro Series Tables

Safco® Products marketing materials are designed to be used as sales tools for our Dealer network.

- Available in dining (29") or bar (42") heights
- Stainless Steel base with square tube support
- Quick and easy assembly
- TFL = 1" tops; HPL = 1½" tops
- Four leveling glides integrated to underside of base
- Tables available in either Thermally Fused Laminate with standard T-Mold or High Pressure Laminate with your choice of 2 edge treatments
- HPL edge Treatments: Knife Edge (HK), or T-Mold (HT) available in corporate edge colors
- See page 10 for corporate laminate color options or go to Safco website

## Bistro Dining-Height Tables

Model No.	Description	Wt.	TFL List Price "T" Suffix	HPL List Price HT or HK Suffix
<b>Dining-Height Models</b>				
CA30SLS	30"W x 30"D x 29"H Square Table	80	887.00	1,339.00
CA30RLS	30" Dia. x 29"H Round Table	75	887.00	1,339.00
CA36SLS	36"W x 36"D x 29"H Square Table	95	982.00	1,509.00
CA36RLS	36" Dia. x 29"H Round Table	85	982.00	1,509.00
CA42RLS	42" Dia. x 29"H Round Table	95	1,293.00	1,625.00
CA3PL	72"W x 30"D x 29"H Peanut Table	126	2,277.00	2,735.00



CA30SLS



CA30RLS

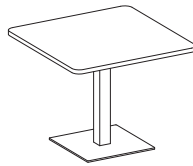

CA36SLS



CA36RLS

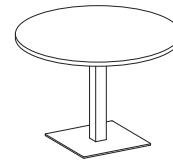

CA42RLS

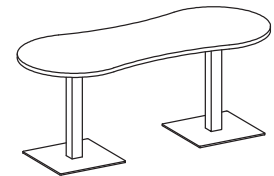

CA3PL

## Bistro Bar-Height Tables

Model No.	Description	Wt.	TFL List Price "T" Suffix	HPL List Price HT or HK Suffix
<b>Bar-Height Models</b>				
CA30SHS	30"W x 30"D x 42"H Square Table	82	910.00	1,364.00
CA30RHS	30" Dia. x 42"H Round Table	77	910.00	1,364.00
CA36SHS	36"W x 36"D x 42"H Square Table	97	1,007.00	1,534.00
CA36RHS	36" Dia. x 42"H Round Table	87	1,007.00	1,534.00
CA42RHS	42" Dia. x 42"H Round Table	97	1,317.00	1,578.00
CA3PH	72"W x 30"D x 42"H Peanut Table	132	2,598.00	3,248.00



CA30SHS

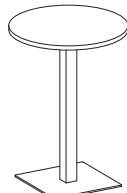

CA30RHS

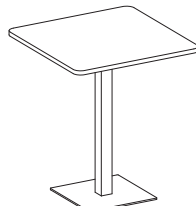

CA36SHS



CA36RHS



CA42RHS

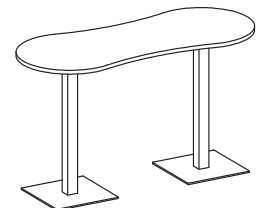

CA3PH









Two Base Models Offered: 2 stage base and 3 stage base offered in two column models.

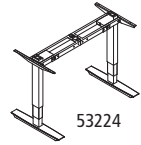
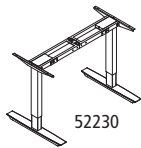

- Drive System: 110V, 60Hz AC input 120V DC motor. Draws a maximum of 3 amps.
- Travel Range: 2 stage - 19.6" of vertical adjustment from 28" to 47.6" (with feet and work surface)
- 3 Stage - 25.5" of vertical adjustment from 24.5" - 50" (with feet and work surface)
- Adjustment Speed: 2 stage .75" per second; 3 stage 1.5" per second
- Control Switch: Simple UP/Down Control Switch sold as standard. LED 4 position preset control available as an accessory option.
- Work surfaces: 1 1/8" high pressure laminate with 3mm PVC (square corners) as standard. Add a "T" suffix to the part number if T-mold is preferred (radius corners) Surfaces available from 48" - 72"W and 24" or 30"D
- See page 10 for Safco corporate laminate color options or go to Safco website
- Keyboard Surface: Optional mechanism extends keyboard range to 8" below and/or 7" above the monitor surface. Tilt range is +15° to -15° tilt
- Bases: Consists of heavy-duty all steel legs with expandable/adjustable steel frames, range from 40" - 68"W which accommodate 48" - 72" work surfaces
- 3 base colors - Silver, Black, and White powder coat paint, customers should designate selection with S for Silver, B for Black and W for White
- Bases Ship KD. Due to the precision of the alignment of the height-adjustable legs, it is critical that the unit be properly leveled for optimum performance
- Load Capacity: 220 lbs. for 2-column models
- Meets ADA and BIFMA performance standards
- Meets Intertek VOC+ Certification

## ML-Series Height-Adjustable Tables





Model No.	Description	Height Range	Wt.	List Price
<b>2 Stage/2 Column Base Only</b>  				
52224	2 Stage/2 Leg 24" Depth	28 - 47 5/8" H	69	1,517.00
52230	2 Stage/2 Leg 30" Depth	28 - 47 5/8" H	71	1,517.00
<b>3-Stage/2-Column Base Only</b>  				
53224	3 Stage/2 Leg 24" Depth	24 1/2 - 50" H	76	1,669.00
53230	3 Stage/2 Leg 30" Depth	24 1/2 - 50" H	78	1,581.00



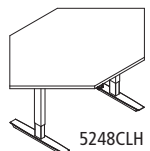

Model No.	Description	Height Range	Wt.	List Price
<b>2 Stage/2 Column Base with 1 1/8" Rectangular Surfaces</b>  				
5222448H	48 x 24"	28 - 47 5/8" H	116	2,034.00
5222454H	54 x 24"	28 - 47 5/8" H	121	2,077.00
5222460H	60 x 24"	28 - 47 5/8" H	126	2,189.00
5222466H	66 x 24"	28 - 47 5/8" H	131	2,316.00
5222472H	72 x 24"	28 - 47 5/8" H	136	2,280.00
5223048H	48 x 30"	28 - 47 5/8" H	131	1,935.00
5223054H	54 x 30"	28 - 47 5/8" H	138	2,193.00
5223060H	60 x 30"	28 - 47 5/8" H	141	2,270.00
5223066H	66 x 30"	28 - 47 5/8" H	146	2,236.00
5223072H *	72 x 30"	28 - 47 5/8" H	151	2,437.00

\*Models that does not ship via small parcel

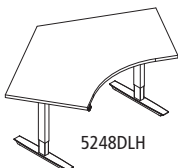

Model No.	Description	Height Range	Wt.	List Price
<b>2 Stage/2 Column Base with 1 1/8" Corner Surfaces</b>  				
5248CSLH	48 x 24"	28 - 47 5/8" H	130	2,276.00
5248CLH	48 x 30"	28 - 47 5/8" H	135	2,316.00









Model No.	Description	Height Range	Wt.	List Price
<b>2 Stage/2 Column Base with 1 1/8" 120° Surfaces</b>  				
5248DSLH	48 x 24"	28 - 47 5/8" H	135	2,360.00
5248DLH *	48 x 30"	28 - 47 5/8" H	140	2,425.00
5242DSLH	42 x 24"	28 - 47 5/8" H	130	2,431.00
5242DLH	42 x 30"	28 - 47 5/8" H	135	2,467.00

\*Models that does not ship via small parcel

# ML-Series Height-Adjustable Tables

Safco® Products marketing materials are designed to be used as sales tools for our Dealer network.

Model No.	Description	Height Range	Wt.	List Price
<b>3 Stage/2 Column Base with 1 1/8" Rectangular Surfaces</b>  				
5322448H	48 x 24"	24 1/2 - 50"H	109	2,085.00
5322454H	54 x 24"	24 1/2 - 50"H	114	2,332.00
5322460H	60 x 24"	24 1/2 - 50"H	119	2,280.00
5322466H	66 x 24"	24 1/2 - 50"H	124	2,467.00
5322472H	72 x 24"	24 1/2 - 50"H	129	2,441.00
5323048H	48 x 30"	24 1/2 - 50"H	124	2,091.00
5323054H	54 x 30"	24 1/2 - 50"H	129	2,236.00
5323060H	60 x 30"	24 1/2 - 50"H	134	2,422.00
5323066H	66 x 30"	24 1/2 - 50"H	139	2,383.00
5323072H	72 x 30"	24 1/2 - 50"H	144	2,582.00
<b>3 Stage/2 Column Base with 1 1/8" Corner Surfaces</b>  				
5348CSLH	48 x 24"	24 1/2 - 50"H	144	2,317.00
5348CLH	48 x 30"	24 1/2 - 50"H	149	2,352.00
<b>3 Stage/2 Column Base with 1 1/8" 120° Surfaces</b>  				
5348DSLH	48 x 24"	24 1/2 - 50"H	144	2,533.00
5348DLH	48 x 30"	24 1/2 - 50"H	149	2,697.00
5342DSLH	42 x 24"	24 1/2 - 50"H	139	2,582.00
5342DLH	42 x 30"	24 1/2 - 50"H	149	2,697.00
<b>Accessories</b> 				
524MC	4-Position Memory Control (for ML series only)		2	152.00

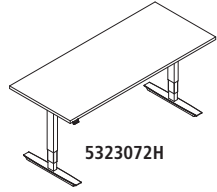

5323072H



5348CSLH

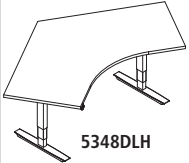

5348DLH

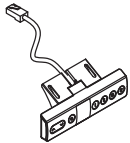

## ML-Series Height-Adjustable Tables - Quick Ship Kits

### Quick Ship Kits

- Tops available in Fusion Maple HPL laminate with 3mm White edge band (FUMPWI) only
- Base options: 2 stage, 2 leg or 3 stage, 2 leg in Black (BL), White (WH) or Silver (SL)
- Example: ML222460-WH-FUMPWI (or ML222460WHFUMPWI) ML 2 stage, 2 leg base in White (WH) with 24x60" Fusion Maple top with White edge band (FUMPWI)

Model No.	Description	Height Range	Wt.	List Price
<b>ML-Series Base &amp; Top</b>				
ML222460	24 x 60" 2 Stage, 2 Legs	28" to 47 1/2"H	104	2,049.00
ML223060	30 x 60" 2 Stage, 2 Legs	28" to 47 1/2"H	111	2,064.00
ML322460	24 x 60" 3 Stage, 2 Legs	24 1/2 - 50"H	110	2,188.00
ML323060	30 x 60" 3 Stage, 2 Legs	24 1/2 - 50"H	117	2,202.00

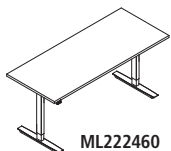

ML222460

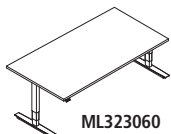

ML323060

- Drive System: 110V, 60 H input, 24V DC motor. 150 lb. capacity. Draws 1.2 amps under full load
- Travel Range: 16" of vertical adjustment from 26" to 42": Full travel time is 37 seconds
- Keyboard Surface: Data Center mechanism adjusts from 8" below to 7" above work surface. Both have +15° to -15° tilt
- Work Surfaces: Thermally-fused low-pressure laminate with T-mold edge is standard. Add "L" suffix for high pressure laminate with T-mold edge (prices shown)
- DataCenter Surface: 11"D x 27"W (minimum) for rectangular configurations
- Base Color: All corporate colors available (see page 10 or Safco website)
- Meets ANSI / BIFMA performance standards
- Control switch standard with up / down only

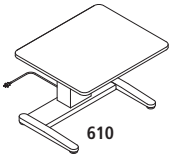

Model No.	Description	Height Range	Wt.	TFL List Price	HPL List Price
<b>E-Series - Single Surface</b>					
615S	48 x 24", use 6043 E-Series Base only	26 - 42"H	126	3,005.00	3,278.00
605	36 x 30", use 6043 E-Series Base only	26 - 42"H	123	2,830.00	3,094.00

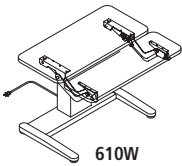

Model No.	Description	Height Range	Wt.	TFL List Price	HPL List Price
<b>E-Series - Dual Surface with 11"D Data Center Keyboard Mechanism</b>					
610W	42 x 31" with DataCenter, use 6043 E-Series Base only	26 - 42"H	149	4,610.00	4,688.00
615W	48 x 31" with DataCenter, use 6043 E-Series Base only	26 - 42"H	155	4,463.00	4,837.00

Note: Data Center keyboard mechanisms are available. Please see below and page 233 for more details.

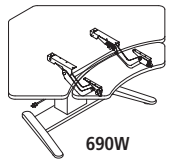

Model No.	Description	Height Range	Wt.	TFL List Price	HPL List Price
<b>E-Series - Single Surface Corner Unit</b>					
650S	42 x 24", use 6043 or 6047 E-Series Base	26 - 42"H	132	3,640.00	3,911.00

Model No.	Description	Height Range	Wt.	TFL List Price	HPL List Price
<b>E-Series - Corner Dual Surface with Data Center Keyboard Mechanism</b>					
650SW	42 x 24", use 6043 or 6047 E-Series Base	26 - 42"H	150	5,073.00	5,074.00

Model No.	Description	Height Range	Wt.	TFL List Price	HPL List Price
<b>E-Series Curved - Corner Dual Surface with Data Center Keyboard Mechanism</b>					
680W	42 x 30", use 6043 or 6045 E-Series Base	26 - 42"H	155	5,855.00	6,280.00
690W	48 x 30", use 6043 or 6045 E-Series Base	26 - 42"H	172	5,871.00	6,274.00

## Data Center Keyboard Mechanism

Sit/Stand height-adjustable keyboard arm with paddle actuated spring brake height adjustment and lever for tilt. Variable width configurations, fixed mount application. Available in 19", 26.25" widths.

Please contact Customer Care for compatibility on rectangular and corner workstations to insure proper fit.

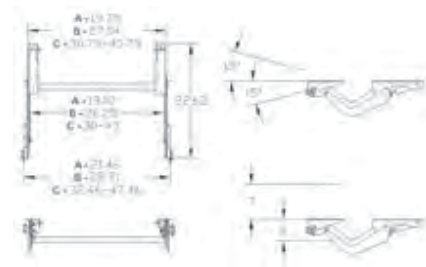

Model No.	Description	Wt.	List Price
49263	Data Center 19"W	22	1,313.00
49264	Data Center 26 1/4"W	22	1,313.00
49265	Data Center 30 - 45" Adjustable Width	22	1,313.00

## XR-SERIES

**Drive System:** 24V, Chain Drive, DC motor. 2-leg system has 250 lbs. lifting capacity and draws a maximum of 3 amps. The 3-leg system has 375 lbs. of lifting capacity and draws a maximum of 4.5 amps start-up and full load.

**Travel Range:** 26.5" of vertical adjustment from 24" to 50.5" by way of simple to use control switch. Full travel time is 16 seconds.

**Work Surfaces:** 1-1/8" high pressure laminate HPL with T-mold edge is standard.

**Data Center Surfaces:** 11" D x 30" W (minimum) for rectangular configurations.

**Meets ADA standards.**

**Keyboard Surface:** Optional mechanism extends keyboard range to 8" below and/or 7" above monitor surface. Tilt range is +15° to -15° tilt.

**Control Switch:** Standard with 3 position memory settings.

**Base:** Consists of 14-gauge legs and rigid 14-gauge cross brace. Available in Black or Silver only. Base ships KD. Due to the precision alignment of the height-adjustable legs, it is critical the unit is properly leveled for optimum performance.

Model No.	Description	Wt.	Base Only
<b>XR-Series</b>	Base Only-includes columns, control box, cross brace, cables and switch. Height-Range 24 - 50 1/2" H		List Price
<b>5065TB</b>	For 24 x 48 x 72 x 24" Right-Hand Return - 3 Columns	65	4,654.00
<b>5075TB</b>	For 24 x 72 x 48 x 24" Left-Hand Return - 3 Columns	65	4,436.00
<b>5045TB</b>	For 72 x 24 x 72" Corner, 3 Columns	68	4,664.00
<b>5055TB</b>	For 84 x 24 x 84" Corner, 3 Columns	73	4,552.00
<b>5095TB</b>	For 72 - 84 x 24" D Surfaces, 2 Columns	54	3,507.00
<b>502TB</b>	For 36 - 42" Surfaces, 2 Columns, 30" Deep	47	3,479.00
<b>503TB</b>	For 48 - 60" Surfaces, 2 Columns 30" Deep	50	3,607.00
<b>508TB</b>	For 60 - 72", 30"D Surfaces, 2 Columns	53	3,438.00
<b>506TB</b>	For 30 x 48 x 72 x 30", Right-Hand Return, 3 Columns	67	4,723.00
<b>507TB</b>	For 30 x 72 x 48 x 30", Left-Hand Return, 3 Columns	67	4,723.00
<b>504TB</b>	For 72 x 30 x 72" Corner - 3 Columns	70	4,732.00
<b>505TB</b>	For 84 x 30 x 84" Corner - 3 Columns	75	4,848.00

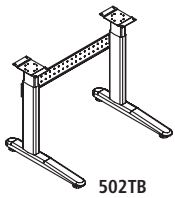

502TB

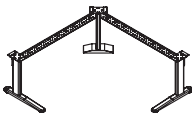

504TB

XR-Series	Single Surface Rectangular		Height Range	Wt.	HPL List Price
<b>505SL</b>	36 x 24"		24 - 50 1/2" H	80	3,885.00
<b>510SL</b>	42 x 24"		24 - 50 1/2" H	87	4,047.00
<b>515SL</b>	48 x 24"		24 - 50 1/2" H	94	4,160.00
<b>520SL</b>	60 x 24"		24 - 50 1/2" H	107	4,393.00
<b>525SL *</b>	72 x 24"		24 - 50 1/2" H	130	4,485.00

\* Models that does not ship via small parcel

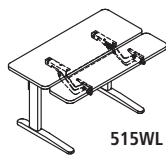

515WL

XR-Series	Dual Surface Rectangular with Data Center Mechanism		Height Range	HPL List Price	
<b>505WL</b>	36 x 30"		24 - 50 1/2" H	110	5,216.00
<b>510WL</b>	42 x 30"		24 - 50 1/2" H	119	5,317.00
<b>515WL</b>	48 x 30"		24 - 50 1/2" H	131	5,446.00

**CORSICA® CONFERENCE ROOM FURNITURE**

Surfaces: Sierra Cherry finish on Cherry veneer-CRY and Mahogany finish on Walnut veneer-MAH.

- Built-in cable management panel features a flush, removable wood cover
- Tabletop is 2" thick with Black beveled edge
- Work surfaces are protected with two-coats of high-tech catalyzed lacquer finish
- Tables larger than 96"L have multi-piece top surfaces connected via steel connecting plates
- Supports up to 500 lbs., evenly distributed
- Tops and base ship separately
- For optional Power Module with cover for full table add suffix "P" to end of the model number
- Each power module plugs in separately

**BOAT SHAPED CONFERENCE TABLES**

Model No.	Description	Dimensions	Weight	List Price	List Price (P)
CTC72	6' Conference Table	72"W x 36"D x 29½"H	226	2,761.00	3,709.00
CTC84	7' Conference Table	84"W x 42"D x 29½"H	297	3,265.00	4,216.00
CTC96	8' Conference Table	96"W x 42"D x 29½"H	340	4,062.00	5,014.00
CTC120	10' Conference Table	120"W x 48"D x 29½"H	372	5,856.00	7,750.00
CMT12	12' Conference Table	144"W x 54"D x 29½"H	620	9,866.00	11,862.00
CMT14	14' Conference Table	168"W x 54"D x 29½"H	713	10,990.00	12,990.00
CTRND	Round Conference Table	42" Diameter x 29½"H	80	1,510.00	
CTWP	Wood Grommet Cover with Module for CTC72, CTC84, or CTC96, CTC120			1,006.00	1,006.00
CTW72SP	Power Module w/Cover for (1) End Section for CMT12, CMT18			1,072.00	1,072.00
CTW72AP	Power Module w/Cover for (1) Center Section for CMT18, CMT20			1,002.00	1,002.00
CTW84SP	Power Module w/Cover for (1) End Section for CMT14, CMT20			1,072.00	1,072.00

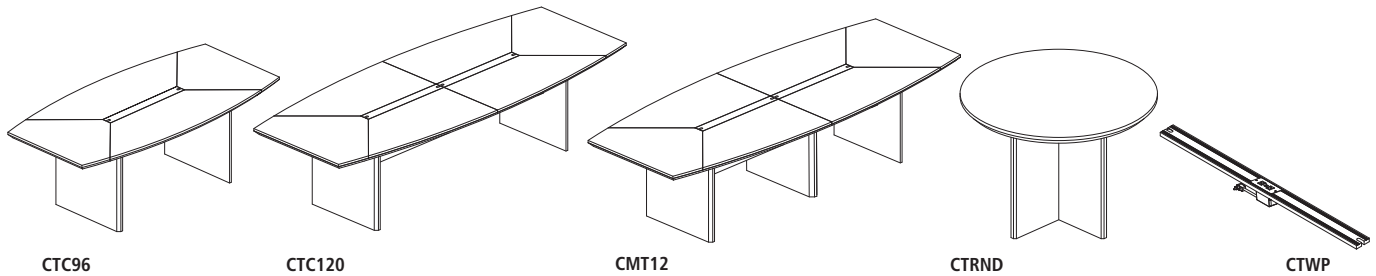

CTC96

CTC120

CMT12

CTRND

CTWP

Office Suites  
Seating  
Tables & Desks  
Meeting Essentials  
Personal Organization  
Ergonomics  
High Density Storage  
Storage & Filing  
Facilities  
Technology Furniture  
Art & Engineering  
K-12 Education  
SAFE Collection Addendum

Full-size conference tables with optional power and data modules designed for optional power and data access to operate computers and presentation equipment during meetings.

- Three shapes of conference surfaces: Racetrack, Boat and Rectangular
- All tables are 29"H overall
- All tables standard with two legs, except for 120" with three legs
- Table legs are constructed of 14-gauge steel and available in standard Black finish
- Tops constructed of 1½" thick high pressure laminate with t-mold edge
- Tables can be ordered with Black grommets
- If ordering optional Power Module, table must be ordered with grommets
- **Base and Grommet Options:** For Premier Leg and grommets add suffix "P" or for Premier Leg and no grommets add suffix "PN" to the end of the model number. **72"W Conference table comes with only 1 grommet and all other 2 grommets.**
- **Base Finish:** List prices shown are for Black base finish. The bases can be finished in any other standard finish for a \$50 list upcharge. Add a "C" suffix after the model number and specify standard finish: **see page 10 for Corporate paint colors details**
- **Work surfaces available in CSII™ colors, see page 10 for Safco corporate Laminates and Paint colors or go to Safco website to view color swatches**

CSII CONFERENCE TABLES

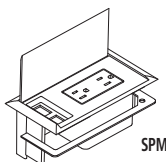
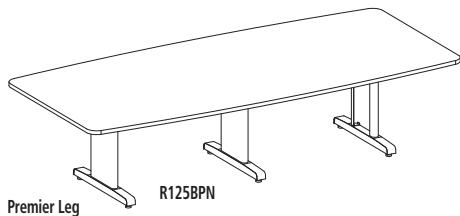
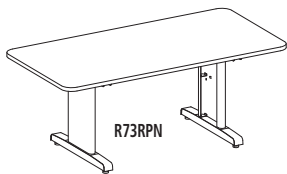

Conference Tables		Premier Leg Grommets (+P) List Price	Premier Leg No Grommets (+PN) List Price
Model No.	Description		
R73R	72 x 36" Rectangular	n/a	2,690.00
R73B	72 x 36" Boat-Shaped	n/a	2,690.00
R73V	72 x 36" Racetrack	n/a	n/a
R84R	84 x 42" Rectangular	3,014.00	2,943.00
R84B	84 x 42" Boat-Shaped	3,014.00	2,943.00
R84V	84 x 42" Racetrack	3,014.00	2,943.00
R94R	96 x 48" Rectangular	3,088.00	3,018.00
R94B	96 x 48" Boat-Shaped	3,088.00	3,018.00
R94V	96 x 48" Racetrack	3,088.00	3,018.00
R95V	96 x 54" Racetrack	3,168.00	3,091.00
R104R	108 x 48" Rectangular	3,547.00	3,466.00
R104B	108 x 48" Boat-Shaped	3,547.00	3,466.00
R104V	108 x 48" Racetrack	3,547.00	3,466.00
R124R	120 x 48" Rectangular	4,071.00	3,992.00
R124B	120 x 48" Boat-Shaped	4,071.00	3,995.00
R124V	120 x 48" Racetrack	4,071.00	3,995.00
R125R	120 x 54" Rectangular	n/a	4,219.00
R125B	120 x 54" Boat-Shaped	n/a	4,219.00

Optional Power Module

Model No.	Description	List Price
SPM	Optional Power Module [includes RJ11-Cat 3 coupler (phone) and RJ45-Cat3 coupler (data)] – 6' power cord	448.00

Office Suites  
Seating  
Tables & Desks  
Meeting Essentials  
Personal Organization  
Ergonomics  
High Density Storage  
Storage & Filing  
Facilities  
Technology Furniture  
Art & Engineering  
K-12 Education  
SAFE Collection Addendum

**NAPOLI CONFERENCE TABLES**



Available in three finishes, Napoli features AA-grade select North American hardwood veneers.

Surfaces: Sierra Cherry finish on Cherry veneer-CRY, Mahogany finish on Walnut veneer-MAH and Charcoal finish on Oak veneer-CGR

- All veneer surfaces are protected with two coats of high-tech catalyzed lacquer
- Grommet hole cutout size is 2¾ x 6"

Model No.	Description	Dimensions	Weight	List Price
NC6	6' Conference Table	72"W x 36"D x 29½"H	197	3,122.00
NC8	8' Conference Table	96"W x 42"D x 29½"H	236	3,886.00
NC10	10' Conference Table	120"W x 48"D x 29½"H	306	5,498.00
NC12	12' Conference Table	144"W x 54"D x 29½"H	358	8,957.00
NC14	14' Conference Table	168"W x 54"D x 29½"H	399	9,375.00
NCR48	Round Conference Table	48" Diameter x 29½"H	135	2,581.00
CTMB	Presentation Board	48 x 48 x 3¼"	110	2,708.00

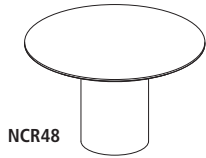

NCR48

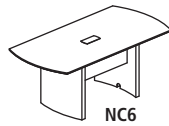

NC6

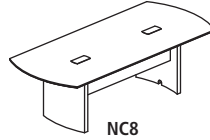

NC8

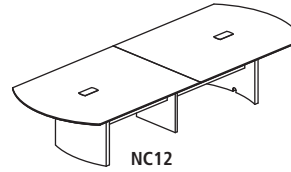

NC12

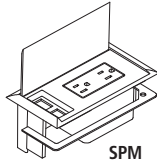

SPM

Model No.	Description	List Price
SPM	6¼"W x 4"D x 1½"H Optional Power Module, UL Listed [includes RJ11-Cat 3 Coupler (phone) and RJ45 Coupler (data)] – 6' Power Cord. Black only.	448.00

**Sorrento Veneer Conference Room Tables**

**SORRENTO CONFERENCE ROOM TABLES**



- Rectangular shaped conference tables are only available in Bourbon Cherry-SCR
- Boat-shaped conference tables are only available in Espresso-ESP

Model No.	Description	Dimensions	Weight	List Price
SCR48	48" Round Conference Table	48" Diameter x 29½"H	164	3,151.00
SC6	6' Rectangular or Boat-Shaped Conference Table	72"W x 36"D x 29½"H	231	4,812.00
SC8	8' Rectangular or Boat-Shaped Conference Table	96"W x 42"D x 29½"H	281	5,539.00
SC10	10' Rectangular or Boat-Shaped Conference Table	120"W x 48"D x 29½"H	370	7,749.00
SC12	12' Rectangular or Boat-Shaped Conference Table	144"W x 54"D x 29½"H	514	13,883.00
SCWB	Presentation Board	48"W x 48"H x 3¼"D	109	3,259.00

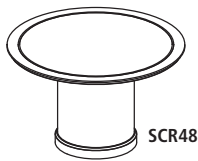

SCR48

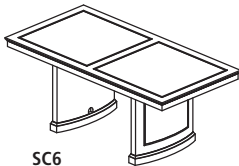

SC6

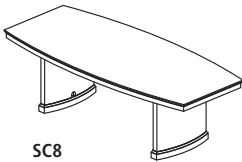

SC8

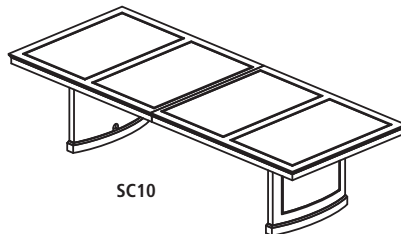

SC10

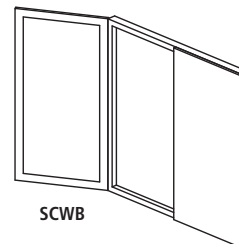

SCWB



# Training Table Power Options

Safco® Products marketing materials are designed to be used as sales tools for our Dealer network.

- UL Listed Components
- Non-sequential connections
- Convenient kits provide easy specifying
- Electrical kits not available for 18" Flip-N-Go®, 18" & 24" Sync® Table

- It is the customer's responsibility to ensure that the use of electrical systems, including the number of receptacles on a given circuit and connection to a building power source, be in compliance with all electrical codes
- Power Infeed Option sections has limitations of number of linked tables, see charting below

## Power Infeed Options

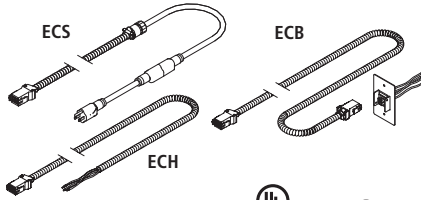

Model No.	Description	List Price
ECS	72" Corded Starter (limit 10 tables linked)	432.00
ECB	Quick Disconnect block & 72" cable with Black wrap (limit 10 tables linked)	420.00
ECH	Hardwire Infeed, 72" with Black wrap (limit 10 tables linked)	279.00

NOTE: Power Infeed Option must be added to the first table in a run.

## Undersurface Kits

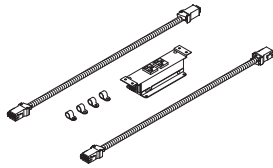

Model No.	Description	List Price
EC48UB	48" Table Kit – 2 power receptacles	667.00
EC60UB	60" Table Kit – 2 power receptacles	660.00
EC66UB	66" Table Kit – 2 power receptacles	667.00
EC72UB	72" Table Kit – 2 power receptacles	667.00
EC48UDB	48" Table Kit – 2 power receptacles/2 data knockouts	717.00
EC60UDB	60" Table Kit – 2 power receptacles/2 data knockouts	717.00
EC72UDB	72" Table Kit – 2 power receptacles/2 data knockouts	717.00

## Top Inset Electrical Kits



- Manufactured cutouts now standard option on select training tables. Applies to Sync® and Flip-N-Go® Tables
- Surface Mount Kits are intended to fit the "E" - style rectangular cutout on the training tables listed above
- Grommet holes can also be field installed – 5/4 x 3" cutout in work surface is required
- Each kit includes a flush grommet

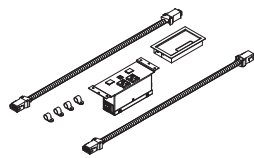

### SURFACE MOUNT KITS With USB

Model No.	Description	List Price
EC48FB	48" Table Kit - Black, 2 power receptacles	880.00
EC48FS	48" Table Kit - Silver, 2 power receptacles	891.00
EC48FJB	48" Table Kit - Black, 2 power receptacles/2 data knockouts, two 2.1 Amp USB charging ports	938.00
EC48FJS	48" Table Kit - Silver, 2 power/2 data receptacles, two 2.1 Amp USB charging ports	927.00
EC54FB	54" Table Kit - Black, 2 power receptacles	880.00
EC54FS	54" Table Kit - Silver, 2 power receptacles	880.00
EC60FB	60" Table Kit - Black, 2 power receptacles	880.00
EC60FS	60" Table Kit - Silver, 2 power receptacles	880.00
EC60FDB	60" Table Kit - Black, 2 power receptacles/2 data knockouts	927.00
EC60FDS	60" Table Kit - Silver, 2 power receptacles, 2 data receptacles	938.00
EC60FJB	60" Table Kit - Black, 2 power/2 data receptacles, two 2.1 Amp USB charging ports	938.00
EC60FJS	60" Table Kit - Silver 2 power/2 data receptacles, two 2.1 Amp USB charging ports	927.00
EC66FB	66" Table Kit - Black, 2 power receptacles	891.00
EC66FS	66" Table Kit - Silver, 2 power receptacles	891.00
EC72FB	72" Table Kit - Black, 2 power receptacles	880.00
EC72FS	72" Table Kit - Silver, 2 power receptacles	880.00
EC72FDB	72" Table Kit - Black, 2 power/2 data receptacles	938.00
EC72FDS	72" Table Kit - Silver, 2 power/2 data receptacles	938.00
EC72FJB	72" Table Kit - Black, 2 power/2 data receptacles, two 2.1 Amp USB charging ports	927.00
EC72FJS	72" Table Kit - Silver, 2 power/2 data receptacles, two 2.1 Amp USB charging ports	927.00

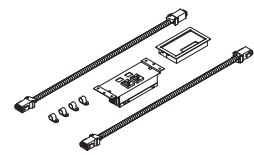

### SURFACE MOUNT KITS With DATA

## Extension Option



Model No.	Description	List Price
ECX	12" Extension Cable	150.00
ECG	Grommet Cover (5.69 x 3.38)	155.00







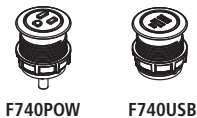

## Electrical/USB Accessories



- Power and USB grommet options - available in White (W) or Black (B)
- Grommet modules are intended to fit the "G" or "M" cutouts on the training tables Sync® and Flip-N-Go® Tables
- Grommet holes can also be field installed - 1 1/4" cutout required
- Spill proof

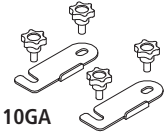

Model No.	Description	List Price
F740POWB	Power Module Single Outlet - Black; 72" cord	95.00
F740POWW	Power Module Single Outlet - White; 72" cord	95.00
F740USBB	(2) 2 Amp charging USB ports - Black; 72" cord	295.00
F740USBW	(2) 2 Amp charging USB ports - White; 72" cord	295.00

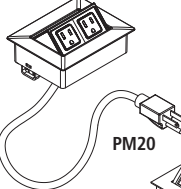
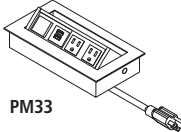
Model #	Description	Table Laminates	List Price Ea.	List Carton Price	Quantity Per Carton	Number of Cartons	Actual Weight	S-Parcel Billable Weight	Carton Cube	Freight Class
 <b>2059BL</b>	Clamp-On Power Module Fits on Tables ¾" - 1¼" Thick, 4"W x 4½"D x 4"H <b>Finish: Black-BL</b>	2059BL	179.00	179.00	1	1	2	4	0.31	775
 <b>2078BL</b>	Clamp-On Power Module with 2 USB charging ports Fits on Tables ¾" - 1¼" Thick, 4"W x 4½"D x 4"H <b>Finish: Black-BL</b>	2078BL	211.00	211.00	1	1	2.5	4	0.31	775
 <b>2069BL</b>	Pull-Up Power Module with 2 USB charging ports (fits Standard 60mm Cable Grommet hole)	2069BL	161.00	161.00	1	1	3	3	0.15	775
 <b>2060BL</b>	Ganging Connector 2 Connectors/4 Posts Per Set <b>Finish: Black-BL</b> For Rumba™ & Impromptu® Tables Only	2060BL	56.00	56.00	1	1	1	1	0.02	60
 <b>2254BL</b>	Table Hook - 6 Pack <b>Finish: Black-BL</b>	2254BL	93.00	93.00	6	1	1.4	2	0.04	70
 <b>2255BL</b>	Table Hook - 24 Pack <b>Finish: Black-BL</b>	2255BL	259.00	259.00	24	1	6	6	0.13	70
<b>Universal Table Ganging Kit</b>										
• Designed to connect two table edges together, regardless of T-Mold style										
 <b>10GA</b>										
Model No.	Dimensions					Wt.				List Price
<b>10GA</b>	3¾"W x 1½"D x 1"H					1				106.00
<b>Wire/Cable Manager (Black only)</b>										
 <b>F890</b>										
Model No.	Description					Wt.				List Price
<b>F890</b>	Base 6" Diameter, Coil 6½"H Compressed Coil 3½" Diameter, Coil 45"H Expanded					3				179.00
<b>Grommets</b>										
• Available in Black • Field installed grommet holes required										
 <b>F740</b>										
Model No.	Description					Wt.				List Price
<b>F740</b>	Grommet					1				39.00
<b>Power &amp; Data Modules</b>										
• Power & Data options can be easily field installed to tabletops • Field cut grommet holes required • Not compatible with manufactured cutouts										
 <b>PM20</b>										
 <b>PM33</b>										
Model No.	Description					Wt.				List Price
<b>PM20</b>	Black, 2 Power Outlets					2.5				496.00
<b>PM33</b>	Power & Data with 2 Power, 2 USB (Specify Black or Silver)					3				1,034.00

Office Suites  
Seating  
Tables & Desks  
Meeting Essentials  
Personal Organization  
Ergonomics  
High Density Storage  
Storage & Filing  
Facilities  
Technology Furniture  
Art & Engineering  
K-12 Education  
SAFE Collection Addendum



- Multi-purpose, durable folding tables that meet most any need, indoors or out
  - Increased number of connections between the frame and the top providing stronger connection
  - Table height: 29"
  - Does not ship via small parcel
  - **Finishes:** Textured White with Dark Gray hammer-coated frame
- NOTE:** Do not push or drag tables

FOLDING TABLES

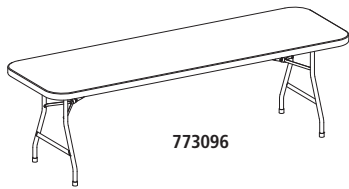
	Model No.	Description	Dimensions	Maximum Weight Load in Pounds	
				Capacity with 1/4" Deflection (Weight must be evenly distributed)	List Price
	773096	7700 Series - 30 x 96" Rectangular	96"W x 30"D x 29"H	300	544.00



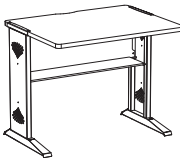
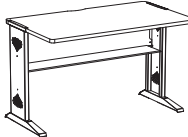
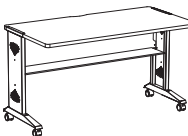





Office Suites  
Seating  
Tables & Desks  
Meeting Essentials  
Personal Organization  
Ergonomics  
High Density Storage  
Storage & Filing  
Facilities  
Technology Furniture  
Art & Engineering  
K-12 Education  
SAFE Collection Addendum





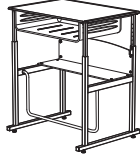

Model #	Description	Table Laminates	List Price Ea.	List Carton Price	Quantity Per Carton	Actual Weight	S-Parcel Billable Weight	Carton Cube	Freight Class
<b>Computer Desks</b>									
	<b>1930</b> Reversible Top Computer Desk, 36 x 28" Overall Size: 35½"W x 28"D x 30"H Finish: Mahogany and Medium Oak	1930	594.00	594.00	1	49	49	3.11	70
	<b>1931</b> Reversible Top Computer Desk, 48 x 28" Overall Size: 47½"W x 28"D x 30"H Finish: Mahogany and Medium Oak	1931	633.00	633.00	1	70	70	4.3	70
	<b>1933</b> Reversible Top Mobile Work Surface, 54 x 28" Overall Size: 53½"W x 28"D x 30"H Finish: Mahogany and Medium Oak	1933	706.00	706.00	1	75	75	4.56	70
	<b>1934</b> Reversible Top Stand, 24 x 28" Overall Size: 23½"W x 28"D x 30"H Finish: Mahogany and Medium Oak	1934	514.00	514.00	1	43	43	3.06	85

Office Suites  
Seating  
Tables & Desks  
Meeting Essentials  
Personal Organization  
Ergonomics  
High Density Storage  
Storage & Filing  
Facilities  
Technology Furniture  
Art & Engineering  
K-12 Education  
SAFE Collection Addendum





# AlphaBetter® 28" W Desks & Stool

Safco® Products marketing materials are designed to be used as sales tools for our Dealer network.

Model #	Description	Model #	List Price Ea.	List Carton Price	Quantity Per Carton	Actual Weight	S-Parcel Billable Weight	Carton Cube	Freight Class
<b>AlphaBetter® Desks &amp; Stools</b>									
	<b>1201BE</b> AlphaBetter® Desk 28 x 20" Standard Top 28"W x 20"D x 26" - 42"H <b>Desktop Finish:</b> Beige-BE Steel Frame with Black Powder Coat Finish Patented Swinging Pendulum™ Footrest Bar	1201BE	764.00	764.00	1	44	52	4.87	110
	<b>1202BE</b> AlphaBetter® Desk, with Book Box 28 x 20" Standard Top 28"W x 20"D x 26" - 42"H <b>Desktop Finish:</b> Beige-BE Steel Frame with Black Powder Coat Finish Patented Swinging Pendulum™ Footrest Bar	1202BE	964.00	964.00	1	50	52	4.87	110
	<b>1203</b> AlphaBetter® Desk 28 x 20" Premium Top 28"W x 20"D x 26" - 42"H <b>Desktop Finish:</b> Gray-GR, Dry Erase-DE Steel Frame with Black Powder Coat Finish Patented Swinging Pendulum™ Footrest Bar	1203GR 1203DE	819.00	819.00	1	43	52	4.87	110
	<b>1204</b> AlphaBetter® Desk 28 x 20" Premium Top 28"W x 20"D x 26" - 42"H <b>Desktop Finish:</b> Gray-GR, Dry Erase-DE Steel Frame with Black Powder Coat Finish Patented Swinging Pendulum™ Footrest Bar	1204GR 1204DE	1,017.00	1,017.00	1	49	52	4.87	110
	<b>1205</b> AlphaBetter® Stool Seat Size: 13" Sq. Overall: 15¼" - 19¼"W x 21" - 35½"H <b>Seat Finish:</b> Beige-BE, Black-BL Steel Frame with Black Powder Coat Finish	1205BE 1205BL	432.00	432.00	1	23	34	3.14	125
	<b>1212BL</b> AlphaBetter® Optional Book Box 22"W x 15"D x 4¼"H <b>Finish:</b> Black-BL	1212BL	196.00	196.00	1	8	15	1.26	250
	<b>1210BL</b> Carpet Casters for AlphaBetter®, Set of 4 Casters: 2½"H <b>Finish:</b> Black-BL	1210BL	28.00	28.00	1	1.2	2	0.08	65
	<b>1211BL</b> Hard floor Casters for AlphaBetter®, Set of 4 Casters: 2½"H <b>Finish:</b> Black-BL	1211BL	39.00	39.00	1	1.3	2	0.08	65

Model #	Description	Model #	List Price Ea.	List Carton Price	Quantity Per Carton	Actual Weight	S-Parcel Billable Weight	Carton Cube	Freight Class
<b>AlphaBetter® Desks &amp; Stools</b>									
	<b>1206BE</b> AlphaBetter® Desk 36 x 24" Standard Top 36" W x 24" D x 26" - 42" H <b>Desktop Finish:</b> Beige-BE Steel Frame with Black Powder Coat Finish Patented Swinging Pendulum™ Footrest Bar	1206BE	878.00	878.00	1	51	77	7.09	110
	<b>1207BE</b> AlphaBetter® Desk, with Book Box 36 x 24" Standard Top 36" W x 24" D x 26" - 42" H <b>Desktop Finish:</b> Beige-BE Steel Frame with Black Powder Coat Finish Patented Swinging Pendulum™ Footrest Bar	1207BE	1,086.00	1,086.00	1	59	77	7.09	110
	<b>1208</b> AlphaBetter® Desk 36 x 24" Premium Top 36" W x 24" D x 26" - 42" H <b>Desktop Finish:</b> Gray-GR, Dry Erase-DE Steel Frame with Black Powder Coat Finish Patented Swinging Pendulum™ Footrest Bar	1208GR 1208DE	930.00	930.00	1	51	77	7.09	110
	<b>1209</b> AlphaBetter® Desk, with Book Box 36 x 24" Premium Top 36" W x 24" D x 26" - 42" H <b>Desktop Finish:</b> Gray-GR, Dry Erase-DE Steel Frame with Black Powder Coat Finish Patented Swinging Pendulum™ Footrest Bar	1209GR 1209DE	1,142.00	1,142.00	1	58	77	7.09	110
	<b>1205</b> AlphaBetter® Stool Seat Size: 13" Sq. Overall: 15¼" - 19¼" W x 21" - 35½" H <b>Seat Finish:</b> Beige-BE, Black-BL Steel Frame with Black Powder Coat Finish	1205BE 1205BL	432.00	432.00	1	23	34	3.14	125
	<b>1212BL</b> AlphaBetter® Optional Book Box 22" W x 15" D x 4¼" H <b>Finish:</b> Black-BL	1212BL	196.00	196.00	1	8	15	1.26	250

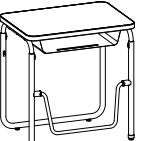
AlphaBetter® Desks 2.0











<b>AlphaBetter® Desks 2.0</b>									
	<b>1221</b> Height-Adjustable Student Desk with Pendulum Bar 22-30" 27¾" W x 19¾" D x 22-30" H <b>Desktop Finish:</b> White Dry Erase Top-DE, Gray Nebula Top-GR <b>Leg Finish:</b> Cityscape Gray	1221DE 1221GR	560.00 516.00	560.00 516.00	1 1	31 31	35 35	1.76 1.76	070 070
	<b>1222</b> Height-Adjustable Student Desk - Pendulum Bar - Book Box 27¾" W x 19¾" D x 22-30" H <b>Desktop Finish:</b> White Dry Erase Top-DE, Gray Nebula Top-GR <b>Leg Finish:</b> Cityscape Gray	1222DE 1222GR	643.00 629.00	643.00 629.00	1 1	37 37	43 43	2.11 2.11	070 070
	<b>1223</b> Height-Adjustable Student Desk with Pendulum Bar 29-43" 27¾" W x 19¾" D x 29-43" H <b>Desktop Finish:</b> White Dry Erase Top-DE, Gray Nebula Top-GR <b>Leg Finish:</b> Cityscape Gray	1223DE 1223GR	602.00 588.00	602.00 588.00	1 1	34 34	38 38	2.1 2.1	070 070
	<b>1224</b> Height-Adjustable Student Desk - Pendulum Bar - Book Box 27¾" W x 19¾" D x 29-43" H <b>Desktop Finish:</b> White Dry Erase Top-DE, Gray Nebula Top-GR <b>Leg Finish:</b> Cityscape Gray	1224DE 1224GR	685.00 671.00	685.00 671.00	1 1	40 40	46 46	2.52 2.52	070 070
	<b>1210BL</b> Carpet Casters for AlphaBetter®, Set of 4, Black-BL Casters: 2½" H	1210BL	28.00	28.00	1	1.2	2	0.08	65
	<b>1211BL</b> Hard floor Casters for AlphaBetter®, Set of 4, Black-BL Casters: 2½" H	1211BL	39.00	39.00	1	1.3	2	0.08	65

Office Suites  
Seating  
Tables & Desks  
Meeting Essentials  
Personal Organization  
Ergonomics  
High Density Storage  
Storage & Filing  
Facilities  
Technology Furniture  
Art & Engineering  
Education  
SAFE Collection Addendum

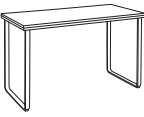
# Flip & Nest Desks

Safco® Products marketing materials are designed to be used as sales tools for our Dealer network.

Office Suites  
Seating  
Tables & Desks  
Meeting Essentials  
Personal Organization  
Ergonomics  
High Density Storage  
Storage & Filing  
Facilities  
Technology Furniture  
Art & Engineering  
K-12 Education  
SAFE Collection Addendum

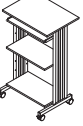
Model #	Description	Model #	List Price Ea.	List Carton Price	Number of Cartons	Actual Weight	S-Parcel Billable Weight	Carton Cube	Freight Class	
<b>Flip and Nest Desks</b>										
	<b>1226</b> Learn Nesting Trapezoid Desk 32 $\frac{3}{8}$ "W x 22 $\frac{1}{4}$ "D x 29 $\frac{1}{2}$ "H Powder coat steel frame <b>Finish:</b> White Dry-Erase Top-DE, Pebbled Gray Top-GR <b>Base Finish:</b> Grey	1226DE 1226GR	664.00	664.00	1	31.1	37	4.15	125	
	<b>1227</b> Learn Nesting Rectangle Desk 28"W x 22 $\frac{1}{4}$ "D x 29 $\frac{1}{2}$ "H Powder coat steel frame <b>Finish:</b> White Dry-Erase Top-DE, Pebbled Gray Top-GR <b>Base Finish:</b> Grey	1227DE 1227GR	636.00	636.00	1	35.4	41	3.16	125	
<b>Studio Desks</b>										
	<b>1950</b> Single Drawer Studio Desk, Wooden Veneer Top Overall Size: 43 $\frac{1}{2}$ "W x 21 $\frac{1}{2}$ "D x 30 $\frac{1}{2}$ "H <b>Frame Finish:</b> Black-BL Single Drawer Studio Desk, Laminate Top <b>Frame Finish:</b> White-W	1950BL 1950WH	715.00	715.00	1	60	62	5.42	110	
	<b>1951</b> Studio Writing Desk, Wooden Veneer Top Overall Size: 37 $\frac{1}{2}$ "W x 22 $\frac{1}{2}$ "D x 34 $\frac{1}{2}$ "H <b>Frame Finish:</b> Black-BL Studio Writing Desk, Laminate Top <b>Frame Finish:</b> White-WH	1951BL 1951WH	451.00	451.00	1	40	43	4.17	110	
<b>Table Desks</b>										
	<b>1943</b> Table Desk Overall Size: 47 $\frac{1}{2}$ "W x 24"D x 28 $\frac{1}{2}$ "H <b>Finish:</b> Beech Top/White Legs-BHWH, Black Top/Silver Legs-BLSL, Cherry Top/Black Legs-CYBL	1943BHWH 1943BLSL 1943CYBL	451.00	451.00	1	36	38	3.34	110	
	<b>Wire Desks</b> <b>5203BL</b> Wire Desk Overall: 35 $\frac{1}{2}$ "W x 24"D x 30 $\frac{1}{2}$ "H Bottom Shelf Dimensions: 35"W x 6 $\frac{1}{4}$ "D <b>Finish:</b> Black-BL	5203BL	245.00	245.00	1	46.4	47	3.64	175	
<b>Muv™ Adjustable-Height Desks</b>										
	<b>1925</b> Muv™ 28" Adjustable-Height Desk Overall Size: 29 $\frac{1}{2}$ "W x 22"D x 29" - 34"H <b>Finish:</b> Cherry-CY	1925CY	834.00	834.00	1	46	46	2.37	70	
	<b>1927</b> Muv™ Mini Tower Adjustable-Height Desk Overall Size: 35 $\frac{1}{2}$ "W x 22"D x 29" - 34"H <b>Finish:</b> Cherry-CY	1927CY	894.00	894.00	1	66	66	3.29	70	
	<b>1929</b> Muv™ Stand-Up Adjustable-Height Desk Overall Size: 29 $\frac{1}{2}$ "W x 22"D x 35" - 49"H <b>Finish:</b> Cherry-CY, Gray-GR, Medium Oak-MO	1929CY 1929GR 1929MO	610.00	610.00	1	56	57	3.51	70	
<b>Muv™ Fixed-Height Desks</b>										
	<b>1921</b> Muv™ 35" Fixed-Height Desk Overall Size: 35 $\frac{1}{2}$ "W x 22"D x 30 $\frac{1}{2}$ "H <b>Finish:</b> Cherry-CY	1921CY	607.00	607.00	1	52	52	2.88	70	
	<b>1923</b> Muv™ Stand-Up Fixed-Height Desk Overall Size: 29 $\frac{1}{2}$ "W x 22"D x 45"H <b>Finish:</b> Cherry-CY, Gray-GR	1923CY 1923GR	580.00	580.00	1	62	62	2.95	70	



Safco® Products marketing materials are designed to be used as sales tools for our Dealer network.



## Vum™ Pneumatic Standing Desk

Model #	Description	Model #	List Price Ea.	List Carton Price	Quantity Per Carton	Actual Weight	S-Parcel Billable Weight	Carton Cube	Freight Class
 1944	Vum™ Pneumatic Standing Desk Overall Size: 25¼"W x 19¼"D x 35½"-47¼"H Finish: Natural Wood-NA, White-WH	1944NA 1944WH	693.00	693.00	1	48.5	49	3.72	70

## Roam™ Touchdown Workstation

 1958	Roam™ Touchdown Workstation Overall Size: 33"W x 30"D x 51½"H Finish: Dark Gray-DG, Tan-TN	1958DG 1958TN	710.00	710.00	1	41	76	6.97	200
--	--	------------------	--------	--------	---	----	----	------	-----

## Scoot™ Steel Desks

 1907BL	Scoot™ Desk Overall Size: 32¼"W x 22"D x 30½"H Finish: Black-BL	1907BL	595.00	595.00	1	38	39	2.33	70
 1908BL	Scoot™ Steel Stand-Up Desk Overall Size: 39½"W x 23¼"D x 42"H Finish: Black-BL	1908BL	689.00	689.00	1	47	47	3.55	70

## Xpressions™ Computer Desks

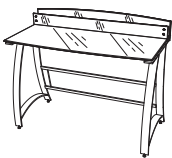
 1938TG	Xpressions™ 47" Computer Desk Overall Size: 47"W x 23"D x 37"H Tempered Glass Top	1938TG	689.00	689.00	1	73	LTL	5.83	70
--	---	--------	--------	--------	---	----	-----	------	----

## Elevate™ Bi-Level & Standing-Height Desks

 1957	Elevate™ Standing-Height Desk Overall Size: 48"W x 24"D x 38" - 50"H Finish: Beech/White-BH, Walnut/Black-WL	1957BH 1957WL	529.00	529.00	1	61	61	4.81	70
--	--	------------------	--------	--------	---	----	----	------	----

## Brio™ Height-Adjustable Standing Desk

 1964WH	Brio™ Height-Adjustable Standing Desk Overall Size: 29½"W x 27¼"D x 37"-50¼"H Finish: White-WH	1964WH	1,038.00	1,038.00	1	48	50	4.81	110
--	--	--------	----------	----------	---	----	----	------	-----





## Verve™ Adjustable-Height Standing Desks

 1959	Verve™ Adjustable-Height Standing Desk Overall Size: 47¼"W x 31¼"D x 36" - 42"H Finish: White-WH, Walnut-WL	1959WH 1959WL	1,051.00	1,051.00	1	80	80	6.32	70
--	---	------------------	----------	----------	---	----	----	------	----

Office Suites  
Seating  
Tables & Desks  
Meeting Essentials  
Personal Organization  
Ergonomics  
High Density Storage  
Storage & Filing  
Facilities  
Technology Furniture  
Art & Engineering  
K-12 Education  
SAFE Collection Addendum

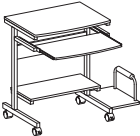
# Eastwinds Furniture Collection

Safco® Products marketing materials are designed to be used as sales tools for our Dealer network.

Model #	Description	Table Laminates	List Price Ea.	List Carton Price	Quantity Per Carton	Actual Weight	S-Parcel Billable Weight	Carton Cube	Freight Class
 946	Portrait PC Desk Cart with Slide-Out Keyboard Tray with Mouse Platform CPU Platform Mounts Left or Right Overall Size: 36½"W x 19¼"D x 31"H Metallic Gray, Powder Coated Steel Frame <b>Finish:</b> Anthracite-ANT, Medium Cherry-MEC	946ANT 946MEC	384.00	384.00	1	42.6	43	2.43	70
 947	Argo PC Workstation with Slide-Out Keyboard Tray and CPU Shelf Overall Size: 31½"W x 19¼"D x 30¼"H Metallic Gray, Powder Coated Steel Frame <b>Finish:</b> Anthracite-ANT, Medium Cherry-MEC	947ANT 947MEC	369.00	369.00	1	34.2	35	1.79	70
 948	FPD Computer Table with Raised Flat Panel Platform Printer and CPU Platform Overall Size: 28½"W x 26"D x 29½"H Metallic Gray, Powder Coated Steel Frame <b>Finish:</b> Anthracite-ANT, Medium Cherry-MEC	948ANT 948MEC	369.00	369.00	1	22	22	1.97	925
 950	Laptop Caddy Split Top Tilts for Ergonomic Use Height-Adjustable Steel Frame Overall Size: 29½"W x 20"D x 27-38"H Metallic Gray, Powder Coated Steel Frame <b>Finish:</b> Anthracite-ANT, Medium Cherry-MEC	950ANT 950MEC	369.00	369.00	1	19.4	20	0.95	70

## Empire Mobile PC Station

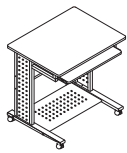

945 Empire Mobile PC Station with Slide-Out Keyboard Tray  
Overall Size: 29½"W x 23½"D x 29¼"H  
Metallic Gray, Powder Coated Steel Frame  
**Finish:** Anthracite-ANT, Medium Cherry-MEC

945ANT 359.00 359.00 1 39 39 2.09 70  
945MEC

## Mirella SOHO Desks

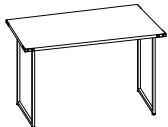

5511 Mirella™ Table Desk  
Overall Size: 48"W x 24"D x 30"H  
**Laminates:** Sand Dune-SDD, White Ash-WAH

5511SDD 402.00 402.00 1 43 41 3.9 110  
5511WAH



5512 Mirella™ Table Desk with Drawer  
Overall Size: 36"W x 22"D x 30"H  
**Laminates:** Sand Dune-SDD, White Ash-WAH

5512SDD 570.00 570.00 1 56 66 5.78 110  
5512WAH

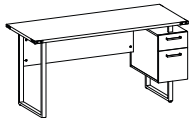







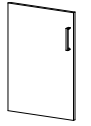
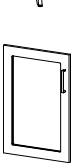

5513 Mirella™ Table Desk with Built-in-Locking Pedestal  
Overall Size: 60"W x 24"D x 30"H  
**Laminates:** Sand Dune-SDD, White Ash-WAH

5513SDD 815.00 815.00 1 92 101 8.24 110  
5513WAH

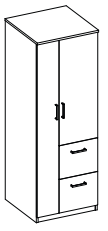
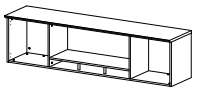

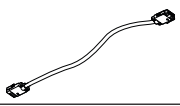
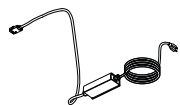
Office Suites  
Seating  
Tables & Desks  
Meeting Essentials  
Personal Organization  
Ergonomics  
High Density Storage  
Storage & Filing  
Facilities  
Technology Furniture  
Art & Engineering  
K-12 Education  
SAFE Collection Addendum

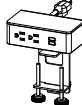
Model #	Description	Model #	List Price Ea.	List Carton Price	Number of Cartons in Shipment	Actual Weight	S-Parcel Billable Weight	Carton Cube	Freight Class
 <b>NEW</b>	<b>RESDES3060WH</b> Resi® Desk 30X60 White Wood Leg Overall: 60"W x 30"D x 29½"H <b>Desk Top:</b> Designer white laminate <b>Base:</b> White Powder Coated Steel Crown with Solid Maple Wood in Natural Finish Legs	RESDES3060WH	1,395.00	1,395.00	1	67	110	8.62	085
 <b>NEW</b>	<b>RESCAB36WH</b> Resi® Cabinet 36W No Doors Overall: 36"W x 19¾"D x 33¾"H <b>Cabinet:</b> Designer white laminate	RESCAB36WH	1,220.00	1,220.00	1	64	82	4.94	070
 <b>NEW</b>	<b>RESDRKTWH</b> Resi® Door Kit - White Overall: 18"W x ¾"D x 25¼"H	RESDRKTWH	236.00	236.00	1	9	21	1.64	070
 <b>NEW</b>	<b>RESGDRKTWH</b> Resi® Glass Door Kit - White Overall: 18"W x ¾"D x 25¼"H	RESGDRKTWH	283.00	283.00	1	8	20	1.64	070
 <b>NEW</b>	<b>RESPEDWH</b> Resi® Skinny Pedestal - White Overall: 11½"W x 19"D x 26½"H	RESPEDWH	672.00	672.00	1	56	58	4.94	125
 <b>NEW</b>	<b>RESWRDWH</b> Resi® Wardrobe 23¾"W x 23¾"D x 68"H	RESWRD1WH RESWRD2WH	1,711.00	1,711.00 334.00	1 1	211.6 38.6	212 78	10.12 7.08	70 100
 <b>NEW</b>	<b>RESH72WH</b> Resi® Hutch 72"W x 16¾"D x 18½"H	RESH72WH	1,382.00	1,382.00	1	120	LTL	20.01	70
 <b>NEW</b>	<b>RESHDRKTWH</b> Resi® Hutch Laminate Door Kit 18¾"W x ¾"D x 17¼"H	RESHDRKTWH	194.00	194.00	1	12.5	14	1.23	85
 <b>NEW</b>	<b>RESHGDRKTWH</b> Resi® Hutch Glass Door Kit 18¾"W x ¾"D x 17¼"H	RESHGDRKTWH	233.00	233.00	1	12.5	14	1.23	85
<b>Resi® Office - Power Units</b>									
 <b>NEW</b>	<b>RESUPDCL</b> Resi® Uni Power Daisy Chain Jumper	RESUPDCL	114.00	114.00	1	6	.06	0.14	070
 <b>NEW</b>	<b>RESUPINP</b> Resi® Universal Power Infeed Plug	RESUPINP	487.00	487.00	1	6	.06	0.35	070
 <b>NEW</b>	<b>RESUPDCWH</b> Resi® Universal Power Unit Daisy Chain White	RESUPDCWH	395.00	395.00	1	6	.06	0.2	070
 <b>NEW</b>	<b>RESUPUWH</b> Resi® Universal Power Unit White	RESUPUWH	336.00	336.00	1	6	.06	0.14	070

Office Suites  
Seating  
Tables & Desks  
Meeting Essentials  
Personal Organization  
Ergonomics  
High Density Storage  
Storage & Filing  
Facilities  
Technology Furniture  
Art & Engineering  
Education  
K-12  
SAFE Collection Addendum

# Ready Collection

Safco® Products marketing materials are designed to be used as sales tools for our Dealer network.

Model #	Description	Model #	List Price Ea.	List Carton Price	Number of Cartons in Shipment	Actual Weight	S-Parcel Billable Weight	Carton Cube	Freight Class
 <b>5508WHNA</b> <small>NEW</small> <small>CS</small>	Ready Collection Desk 45½"W x 23½"D x 29½"H <b>Finish:</b> White Frame with Beigewood Top-WHNA	5508WHNA	423.00	423.00	1	45	45	–	70
 <b>5509WHNA</b> <small>NEW</small> <small>CS</small>	Ready Collection Large Storage Unit 24"W x 12"D x 17½"H <b>Finish:</b> White Frame with Beigewood Top-WHNA	5509WHNA	320.00	320.00	1	30	30	–	70
 <b>5510WHNA</b> <small>NEW</small> <small>CS</small>	Ready Collection Small Storage Unit 24"W x 12"D x 12½"H <b>Finish:</b> White Frame with Beigewood Top-WHNA	5510WHNA	280.00	280.00	1	24	24	–	70

# Ultimate Gaming Desk

 <b>5393</b> <small>NEW</small> <small>CS</small>	Ultimate Gaming Desk - 42" 42¼"W x 23¾"D x 29½"H Includes: Headphone Hook, CupHolder, Multi-Color LED Lighting <b>Finish:</b> Black Base with Black Top-BL Red Base with Black Top-RD	5393BL 5393RD	361.00	361.00	1	33	39.2	4.2	200
---	--	------------------	--------	--------	---	----	------	-----	-----

Office Suites  
Seating  
Tables & Desks  
Meeting Essentials  
Personal Organization  
Ergonomics  
High Density Storage  
Storage & Filing  
Facilities  
Technology Furniture  
Art & Engineering  
K-12 Education  
SAFE Collection Addendum



Model #	Description	Model #	List Price Ea.	List Carton Price	Quantity Per Carton	Actual Weight	S-Parcel Billable Weight	Carton Cube	Freight Class
	<b>2014WBS</b> Rumba™ Screen 36"W x 54"H Full Whiteboard Screen Overall Size: 36"W x 16"D x 54"H	2014WBS	1,253.00	1,253.00	1	31	LTL	5.47	70
	<b>2015WBS</b> Rumba™ Screen 42"W x 54"H Full Whiteboard Screen Overall Size: 42"W x 16"D x 54"H	2015WBS	1,319.00	1,319.00	1	38	LTL	6.3	70
	<b>2016WBS</b> Rumba™ Screen 36"W x 66"H Full Whiteboard Screen Overall Size: 36"W x 16"D x 66"H	2016WBS	1,309.00	1,309.00	1	45	LTL	5.76	70
	<b>2017WBS</b> Rumba™ Screen 42"W x 66"H Full Whiteboard Screen Overall Size: 42"W x 16"D x 66"H	2017WBS	1,381.00	1,381.00	1	41	LTL	6.69	70
	<b>2008GR</b> Rumba™ Screen Eraser Tray	2008GR	46.00	46.00	1	1	1	0.08	100



**Impromptu® Collaboration Screens**

	<b>8510GRCL</b> Impromptu® Acrylic Screen, 42"W x 72"H Mobile on Four Casters (Two Locking) Includes: Accessory Hooks Overall Size: 42"W x 21½"D x 72"H Finish: Metallic Gray-GR	8510GRCL	868.00	868.00	1	45	LTL	5.23	70
	<b>8511</b> Impromptu® Full Whiteboard Screen, 42"W x 72"H Magnetic Whiteboard Includes Accessory Hooks & Magnetic Accessory Tray Overall Size: 42"W x 21½"D x 72"H Finish: Black-BL, Metallic Gray-GR	8511BL 8511GR	868.00	868.00	1	51	LTL	6.15	70
	<b>3611BL</b> Onyx™ Mesh Marker Holder with Shelf Overall Size: 5¼"W x 2½"D x 5¼"H Finish: Black-BL	3611BL	45.00	45.00	1	1	2	0.08	150
	<b>3612BL</b> Onyx™ Mesh Marker Organizer with Basket Overall Size: 8"W x 3"D x 3¾"H Finish: Black-BL	3612BL	46.00	46.00	1	1.2	2	0.1	150
	<b>3909GR</b> Mobile Whiteboard, 30" x 64" - White Dry Erase Board Magnetic board, Cutout in board for easy marker storage Overall Size: 30"W x 24"D x 63¾"H	3909GR	1,709.00	1,709.00	1	80	LTL	-	70

Office Suites  
Seating  
Tables & Desks  
Meeting Essentials  
Personal Organization  
Ergonomics  
High Density Storage  
Storage & Filing  
Facilities  
Technology Furniture  
Art & Engineering  
K-12 Education  
SAFE Collection Addendum

# Mobile Wall, Multimedia & AV Carts

Safco® Products marketing materials are designed to be used as sales tools for our Dealer network.



Model #	Description	Model #	List Price Ea.	List Carton Price	Quantity Per Carton	Actual Weight	S-Parcel Billable Weight	Carton Cube	Freight Class
	<b>Steel AV Height-Adjustable Cart</b> <b>8932BL</b> Steel Height-Adjustable Cart Holds up to 20" monitor; six outlet UL approved mini surge protector with power switch Three shelves, adjustable in 2" increments 28" - 36"H Overall Size: 27¼"W x 18¼"D x 28½" - 36½"H Finish: Black-BL	8932BL	625.00	625.00	1	58	58	2.34	85
	<b>Steel Adjustable AV Cart with Cabinet</b> <b>8943BL</b> Steel Adjustable AV Cart with Cabinet Holds up to 20" monitor; three outlet UL approved mini surge protector with power switch Adjustable in 2" increments 26" - 42"H Overall Size: 26¼"W x 20¼"D x 26" - 42"H Finish: Black-BL	8943BL	1,070.00	1,070.00	1	88	88	4.5	85
	<b>Scoot™ Presentation Cart</b> <b>8945BL</b> Scoot™ Presentation Cart Shelves Adjust in 2¼" Increments 4 Positions (24¼" - 32¼") Overall Size: 21½"W x 30¼"D x 40½"H Finish: Black-BL	8945BL	625.00	625.00	1	50	50	4.63	85



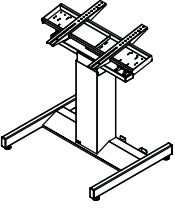

These products are subject to California Proposition 65. Please visit the product detail page on our website for specific information.

Office Suites  
Seating  
Tables & Desks  
Meeting Essentials  
Personal Organization  
Ergonomics  
High Density Storage  
Storage & Filing  
Facilities  
Technology Furniture  
Art & Engineering  
K-12 Education  
SAFE Collection Addendum

## Height-Adjustable Media/Design Centers

Model #	Description	Model #	List Price Ea.	List Carton Price	Quantity Per Carton	Actual Weight	S-Parcel Billable Weight	Carton Cube	Freight Class
<b>Height-Adjustable Design/Media Center</b>									
	<b>HADC</b> Height-Adjustable Design/Media Center Vertical to Horizontal Electric Tilt option standard Max. weight load 150 lbs. Starting Height/ Vertical Orientation 32.5"*** Full Height/Vertical Orientation 50.5"*** Starting Hgt/ Horizontal Orientation 33.5"*** Full Height/Horizontal Orientation 51.5"*** Screen Mounting Pattern Accommodated 400 x 400; 600 x 400* 5 Outlet Powerstrip mounted to base Cable Management Bracket Optional Caster Kit available Overall Base Dimensions: 35"W x 29½"D x 4"H Finish: Black-BL	HADC	11,355.00	11,355.00	1	-	-	-	-
			* Recommend use of commercial grade screens for tilt version to avoid overheating when screen is in horizontal position. ** Approximate dimensions measured to the center of the screen. This can vary depending on location of VESA pattern in relation to the screen. *** Dimension does not include screen thickness. *** Brackets may show if screen is smaller than 40"; varies with VESA pattern location.						
<b>Accessories</b>									
	<b>HACK</b> Caster Kit - four 3" Locking Casters	HACK	261.00	261.00	1	-	-	-	-

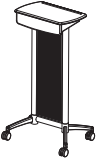
## Presentation Stands & Lecterns

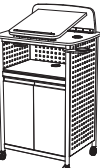

	<b>Impromptu® Lectern</b> <b>8912</b> Steel Frame & Translucent Polycarbonate Panel Top Surface: 20"W x 16"D Overall Size: 26½"W x 18½"D x 46½"H Finish: Black-BL, Metallic Gray-GR	8912BL 8912GR	806.00	806.00	1	33	34	3.2	110
	<b>Executive Mobile Lectern</b> <b>8918</b> Large 23¾"W x 20"D Reading Surface Upper Shelf Adjusts in 2½" Increments Overall Size: 25¼"W x 19"D x 46"H Finish: Mahogany-MH	8918MH	1,135.00	1,135.00	1	96	96	3.39	110
	<b>Executive Presentation Stand</b> <b>8919</b> Large 28"W x 18½"D Presentation Surface 2½"H containment lip Overall Size: 29½"W x 20½"D x 40¾"H Finish: Mahogany-MH	8919MH	1,012.00	1,012.00	1	136	LTL	4.68	110
	<b>Scoot™ Multi-Purpose Lectern</b> <b>8922BL</b> Two swivel cup holders Platform folds down for flat surface Overall Size: 28¾"W x 22"D x 49¾"H Finish: Black-BL	8922BL	995.00	995.00	1	85	85	4.17	70

Office Suites  
Seating  
Tables & Desks  
Meeting Essentials  
Personal Organization  
Ergonomics  
High Density Storage  
Storage & Filing  
Facilities  
Technology Furniture  
Art & Engineering  
K-12 Education  
SAFE Collection Addendum

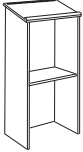

# Presentation Stands & Lecterns

Safco® Products marketing materials are designed to be used as sales tools for our Dealer network.

Model #	Description	Model #	List Price Ea.	List Carton Price	Quantity Per Carton	Actual Weight	S-Parcel Billable Weight	Carton Cube	Freight Class
	<b>Stand-Up Lectern</b> <b>8915</b> Stand-Up Lectern 23"W x 15½"D Reading Surface Slopes at 15° Angle Overall Size: 23"W x 15½"D x 46"H Finish: Mahogany-MH	8915MH	541.00	541.00	1	52	52	2.06	110
	<b>Adjustable Speaker Stand</b> <b>8921</b> Adjustable Speaker Stand 20"W x 16"D Reading Platform Tilts from 0° - 70° Podium height manually adjusts from 30" - 44" Overall Size: 21"W x 21"D x 29½" - 46"H Finish: Mahogany-MH	8921MH	267.00	267.00	1	14	14	0.88	110



# Onyx™ Break Room Organizers

	<b>Onyx™ Break Room Organizers</b> <b>3274BL</b> Onyx™ Break Room Organizer - 1 Drawer 12½"W x 11¼"D x 3¼"H Finish: Black-BL	3274BL	77.00	77.00	1	5	5	0.35	85
	<b>3275BL</b> Onyx™ Break Room Organizer - 3 Drawer 11½"W x 8¼"D x 8¼"H Finish: Black-BL	3275BL	114.00	114.00	1	7	7	0.55	85
	<b>3290BL</b> Onyx™ Mesh Tower Break Room Organizer 6"W x 6"D x 18"H Finish: Black-BL	3290BL	103.00	103.00	1	3	6	0.51	150
	<b>3291BL</b> Onyx™ Mesh Condiment Carton 16"W x 8½"D x 5¼"H Finish: Black-BL	3291BL	103.00	103.00	1	3	7	0.55	125
	<b>3292BL</b> Onyx™ Mesh Cup & Lid Holder 12¾"W x 4½"D x 13¼"H Finish: Black-BL	3292BL	139.00	139.00	1	3	8	0.6	150
	<b>3293BL</b> Onyx™ Mesh Break Room Organizer 14¾"W x 11¼"D x 15"H Finish: Black-BL	3293BL	179.00	179.00	1	6	19	1.72	250





Office Suites  
Seating  
Tables & Desks  
Meeting Essentials  
Personal Organization  
Ergonomics  
High Density Storage  
Storage & Filing  
Facilities  
Technology Furniture  
Art & Engineering  
K-12 Education  
SAFE Collection Addendum

## Hospitality – Wood Refreshment Carts

Model #	Description	Model #	List Price Ea.	List Carton Price	Quantity Per Carton	Actual Weight	S-Parcel Billable Weight	Carton Cube	Freight Class
<b>Wood Refreshment Centers</b>									
	<b>8953</b> Mobile Refreshment Cart Large 21½"W x 17"D Heat-Resistant Countertop: 1½" Raised Lip Overall Size: 23"W x 18"D x 31"H <b>Finish:</b> Gray-GR, Mahogany-MH	8953GR 8953MH	501.00	501.00	1	67	68	2.76	100
	<b>8962</b> Hospitality Service Cart Serving Area: 32½"W x 20½"D with Two Drop Leaves to Expand to 56"W Overall Size: 32½" - 56½"W x 20½"D x 38¾"H <b>Finish:</b> Mahogany-MH, Cherry-CY	8962MH 8962CY	1,102.00	1,102.00	1	143	143	5.75	100

## Hospitality – Steel Refreshment Carts























	<b>Refreshment Stand</b> <b>8963BL</b> Refreshment Cart Large Melamine Top: 29¼"W x 20½"D Overall Size: 29½"W x 22¾"D x 33¼"H <b>Finish:</b> Black-BL	8963BL	971.00	971.00	1	92	92	3.87	100
	<b>Mobile Refreshment Cart</b> <b>8964BL</b> Mobile Refreshment Cart Melamine Top: 33¾"W x 21½"D with 1½"H Wire Rails Mobile on 3½" Casters (two locking) Overall Size: 33½"W x 21¾"D x 43"H <b>Finish:</b> Black-BL	8964BL	894.00	894.00	1	92	LTL	5.86	100
	<b>Impromptu® Mobile Refreshment Cart</b> <b>8966</b> Impromptu® Mobile Refreshment Cart Laminate Top: 34"W x 17"D with Rails Mobile on Four Casters (two locking) Overall Size: 34"W x 21¾"D x 36½"H <b>Finish:</b> Black-BL, Metallic Gray-GR	8966BL 8966GR	1,132.00	1,132.00	1	64	64	4.24	100

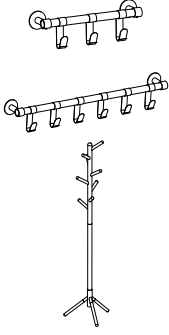











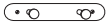

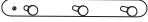

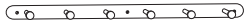
Office Suites  
Seating  
Tables & Desks  
Meeting Essentials  
Personal Organization  
Ergonomics  
High Density Storage  
Storage & Filing  
Facilities  
Technology Furniture  
Art & Engineering  
K-12 Education  
SAFE Collection Addendum

# Coat Racks

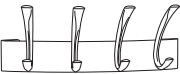
Safco® Products marketing materials are designed to be used as sales tools for our Dealer network.

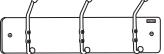
Model #	Description	Model #	List Price Ea.	List Carton Price	Quantity Per Carton	Actual Weight	S-Parcel Billable Weight	Carton Cube	Freight Class
	<b>Nail Head Coat Rack</b> <b>4191NC</b> Spiral Nail Head Coat Rack, 8 Hook 15" Dia. Base x 67"H  	4191NC	263.00	263.00	1	17	17	0.83	85
	<b>Coat Racks</b> <b>4163</b> Coat Rack Four Double Hook 21" Dia. Base x 70"H <b>Finish:</b> Black-BL, Chrome-CR  	4163BL 4163CR	168.00	168.00	1	9	9	0.43	70
	<b>4168</b> Coat Rack with Umbrella Stand 21" Dia. Base x 70"H <b>Finish:</b> Black-BL  	4168BL	218.00	218.00	1	12	17	1.29	85
	<b>Hook Head Coat Racks</b> <b>4241BL</b> Hook Head Coat Rack, 8 Hook 15" Dia. Base x 67"H <b>Finish:</b> Black-BL  	4241BL	174.00	174.00	1	18	18	0.83	100
	<b>Family Coat Rack</b> <b>4256</b> Family Coat Rack, 8 Hook 16½" Dia. Base x 72¾"H <b>Finish:</b> Black-BL  	4256BL	247.00	247.00	1	13	15	1.42	100
	<b>Resi® Coat Rack Collection</b>  <b>4263WH</b> Resi 3 Hook Wall Rack 19¾"W x 4¼"D x 6"H <b>Finish:</b> White-WL with Natural Wood  	4263WH	110.00	110.00	1	3	3	0.22	100
	<b>4264WH</b> Resi 6 Hook Wall Rack 36¼"W x 4¼"D x 6"H <b>Finish:</b> White-WL with Natural Wood  	4264WH	162.00	162.00	1	5	5	0.4	100
	<b>4265WH</b> Resi 8 Hook Coat Tree 17¼"W x 17¼"D x 69½"H <b>Finish:</b> White-WL with Natural Wood  	4265WH	232.00	232.00	1	9	9	0.72	100

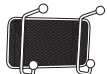
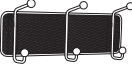
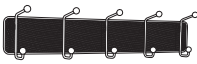

Office Suites  
Seating  
Tables & Desks  
Meeting Essentials  
Personal Organization  
Ergonomics  
High Density Storage  
Storage & Filing  
Facilities  
Technology Furniture  
Art & Engineering  
K-12 Education  
SAFE Collection Addendum

Model #	Description	Model #	List Price Ea.*	List Carton Price	Quantity Per Carton	Actual Weight	S-Parcel Billable Weight	Carton Cube	Freight Class
<b>Nail Head Coat Hooks</b>									
	<b>4200</b> Nail Head Coat Hook - 2 Hook 12"W x 2 3/4"D x 2"H  	4200	62.00	62.00	1	0.6	0.6	0.62	100
	<b>4201</b> Nail Head Coat Hook - 3 Hook 18"W x 2 3/4"D x 2"H  	4201	91.00	91.00	1	1	1	0.71	100
	<b>4202</b> Nail Head Coat Hook - 6 Hook 36"W x 2 3/4"D x 2"H  	4202	174.00	174.00	1	2	2	0.73	100
<b>Metal Coat Racks</b>									
	<b>4203SL</b> Metal Coat Rack - 2 Hook 7"W x 4 1/2"D x 5 1/4"H Finish: Silver-SL * Only available to order by Carton.	4203SL	40.00	240.00	6	5	6	0.25	100
	<b>4205SL</b> Metal Coat Rack - 4 Hook 14 1/4"W x 4 1/4"D x 5 1/4"H Finish: Silver-SL * Only available to order by Carton.	4205SL	60.00	360.00	6	9	9	0.4	100
<b>Wall Rack Coat Hooks</b>									
	<b>4160</b> Wall Rack - 2 Hook 6 1/2"W x 3"D x 7"H Finish: Chrome * Only available to order by Carton.	4160	24.00	288.00	12	10	10	0.31	70
	<b>4161</b> Wall Rack - 3 Hook 18"W x 3 3/4"D x 7"H Finish: Satin Aluminum	4161	65.00	65.00	1	1	2.2	0.63	100
	<b>4162</b> Wall Rack - 6 Hook 36"W x 3 3/4"D x 7"H Finish: Satin Aluminum	4162	125.00	125.00	1	3.87	4.2	0.86	100
<b>Onyx™ Mesh Wall Racks</b>									
	<b>6401BL</b> Onyx™ Mesh Wall Rack - 2 Hook 8 1/2"W x 3"D x 5 1/2"H Finish: Black-BL * Only available to order by Carton.	6401BL	22.00	132.00	6	7	10	0.89	100
	<b>6402BL</b> Onyx™ Mesh Wall Rack - 3 Hook 14 3/4"W x 3"D x 5 1/2"H Finish: Black-BL * Only available to order by Carton.	6402BL	30.00	180.00	6	10	16	1.39	100
	<b>6403BL</b> Onyx™ Mesh Wall Rack - 5 Hook 26 3/4"W x 3"D x 5 1/2"H Finish: Black-BL * Only available to order by Carton.	6403BL	51.00	306.00	6	16	27	2.45	100
<b>Family Coat Wall Racks</b>									
	<b>4255</b> Family Coat Rack 3 Hook 18 1/2"W x 5 1/4"D x 7 1/4"H Finish: Black-BL	4255BL	140.00	140.00	1	10	10	0.18	100
	<b>4257</b> Family Coat Rack 6 Hook 42 1/2"W x 5 1/4"D x 7 1/4"H Finish: Black-BL	4257BL	211.00	211.00	1	16	16	0.4	100



Office Suites  
Seating  
Tables & Desks  
Meeting Essentials  
Personal Organization  
Ergonomics  
High Density Storage  
Storage & Filing  
Facilities  
Technology Furniture  
Art & Engineering  
K-12 Education  
SAFE Collection Addendum

# Coat Hooks - Over-the-Door/Over-the-Panel

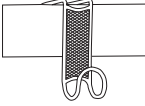
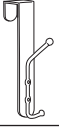
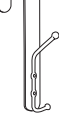





Safco® Products marketing materials are designed to be used as sales tools for our Dealer network.

Model #	Description	Model #	List Price Ea.	List Carton Price	Quantity Per Carton	Actual Weight	S-Parcel Billable Weight	Carton Cube	Freight Class
	<b>Plastic Coat Hooks</b> <b>4224BL</b> Over-the-Panel Single Hook 1 1/4"W x 5/4"D x 4"H Finish: Black-BL * Only available to order by Carton.	4224BL	37.00	222.00	6	6	6	0.33	70
	<b>4225BL</b> Over-the-Panel Double Hook 1 1/4"W x 6 1/2"D x 7 3/4"H Finish: Black-BL * Only available to order by Carton.	4225BL	51.00	306.00	6	7	7	0.43	70
	<b>4227BL</b> Over-the-Door Double Hook 1 1/4"W x 5 1/4"D x 7 3/4"H Finish: Black-BL * Only available to order by Carton.	4227BL	45.00	270.00	6	6	6	0.5	70
	<b>Onyx™ Mesh Coat Hook</b> <b>4229BL</b> Onyx™ Mesh Coat Hook 4 3/4"W x 1 1/4"D x 5"H Finish: Black-BL * Only available to order by Carton.	4229BL	16.00	192.00	12	4	5	0.42	70
	<b>Door &amp; Panel Coat Hooks</b> <b>4166</b> Over-the-Door Coat Hook Fits doors up to 1 1/4" thick 1 1/4"W x 4"D x 8 1/2"H * Only available to order by Carton.	4166	38.00	456.00	12	6	6	0.33	70
	<b>4167</b> Over-the-Panel Coat Hook Adjusts to fit panels from 1 1/2" to 3 1/4" thick 1 1/4"W x 4"D x 8 1/2"H * Only available to order by Carton.	4167	39.00	468.00	12	7	7	0.33	70

# Write Way® Dry Erase Message Signs

	<b>Write Way® Dry Erase Message Signs</b> <b>4173BL</b> Write Way® Directional Sign Arrow Adjusts + or - 45° Overall: 25 1/2"W x 17 1/4"D x 64 1/4"H Finish: Black-BL	4173BL	219.00	219.00	1	10	26	2.41	125
	<b>4117BL</b> Write Way® Rectangular Sign 22 1/4"H x 14 1/4"W Dry Erase Board Overall: 18"W x 18"D x 65"H Finish: Black-BL	4117BL	230.00	230.00	1	10	46	4.19	125
	<b>4118BL</b> Write Way® Octagon Sign Octagon Surface: 19 1/2"W x 19 1/2"H 22 1/2"W x 18"D x 65"H Finish: Black-BL	4118BL	232.00	232.00	1	11	46	4.28	125



Office Suites  
Seating  
Tables & Desks  
Meeting Essentials  
Personal Organization  
Ergonomics  
High Density Storage  
Storage & Filing  
Facilities  
Technology Furniture  
Art & Engineering  
K-12 Education  
SAFE Collection Addendum

	Model #	Description	Model #	List Price Ea.	List Carton Price	Quantity Per Carton	Actual Weight	S-Parcel Billable Weight	Carton Cube	Freight Class	
	<b>Impromptu® Machine Stands</b>										
	<b>1857</b>	Impromptu® Mobile Machine Stand Overall Size: 26¼" W x 21" D x 26½" H Finish: Black-BL, Metallic Gray-GR	1857BL 1857GR	557.00	557.00	1	41	41	2.66	70	
											
	<b>1859</b>	Impromptu® Deluxe Mobile Machine Stand with Doors Overall Size: 34¼" W x 25½" D x 30¼" H Finish: Black-BL, Metallic Gray-GR	1859BL 1859GR	1,049.00	1,049.00	1	67	67	4.1	70	
											
	<b>1862</b>	Impromptu® Under Table Printer Stand Overall Size: 20½" W x 16½" D x 14¼" H Finish: Black-BL	1862BL	363.00	363.00	1	21	21	1.36	70	
											

**Muv™ Printer/Machine Stands**

	Model #	Description	Model #	List Price Ea.	List Carton Price	Quantity Per Carton	Actual Weight	S-Parcel Billable Weight	Carton Cube	Freight Class	
	<b>Muv™ Printer/Machine Stands</b>										
	<b>1881</b>	Muv™ Mobile Machine Stand Overall Size: 29½" W x 20" D x 35" H Bottom Shelves: 25½" W x 13¼" D x ¾" H Top Shelf (Fixed): 29½" W x 19¼" D x ¾" H Finish: Cherry-CY, Medium Oak-MO	1881CY 1881MO	495.00	495.00	1	49	49	2.53	70	
											

**Wood Machine Stands**

	Model #	Description	Model #	List Price Ea.	List Carton Price	Quantity Per Carton	Actual Weight	S-Parcel Billable Weight	Carton Cube	Freight Class	
	<b>Wood Machine Stands</b>										
	<b>1850</b>	Mobile Stand Overall Size: 28" W x 19¼" D x 30¼" H Upper Compartment: 9¼" H Compartments Measure 26" W x 17¼" D Finish: Mahogany-MH	1850MH	751.00	751.00	1	75	75	3.94	70	
											

# Steel Machine Stands

Safco® Products marketing materials are designed to be used as sales tools for our Dealer network.

Model #	Description	Model #	List Price Ea.	List Carton Price	Quantity Per Carton	Actual Weight	S-Parcel Billable Weight	Carton Cube	Freight Class
---------	-------------	---------	----------------	-------------------	---------------------	---------------	--------------------------	-------------	---------------



## Steel Machine Stands

**1870GR** Machine Stand with Drawer  
 Overall Size: 25"W x 20"D x 29½"H  
 Laminate Top: 25"W x 20"D  
 Finish: Gray-GR

1870GR 822.00 822.00 1 66 LTL 10.55 125



**1871GR** Compact Machine Stand  
 Overall Size: 17½"W x 17¼"D x 27¼"H  
 Finish: Gray-GR

1871GR 615.00 615.00 1 40 68 6.18 125



**1872BL** Deluxe Machine Stand  
 Overall Size: 32"W x 24¼"D x 30¾"H  
 Finish: Black-BL

1872BL 1,009.00 1,009.00 1 63 63 2.32 70

# Scoot™ Printer Stands

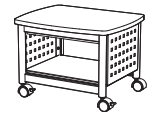

**1855BL** Scoot™ UnderDesk Printer Stand  
 Overall Size: 20¼"W x 16½"D x 14½"H  
 Finish: Black-BL

1855BL 223.00 223.00 1 20 20 1.3 70



**1856BL** Scoot™ Printer Stand  
 Overall Size: 26½"W x 20½"D x 26½"H  
 Finish: Black-BL

1856BL 421.00 421.00 1 45 45 2.18 70

# Wave Printer Stands

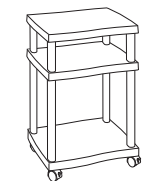

**1860GR** Desk Side Wave Printer Stand  
 Overall Size: 20"W x 17½"D x 29¼"H  
 Finish: Gray-GR

1860GR 234.00 234.00 1 18 18 1.54 925





**1861GR** UnderDesk Wave Printer Stand  
 Overall Size: 20"W x 17½"D x 11½"H  
 Finish: Gray-GR

1861GR 147.00 147.00 1 11 12 1.09 925

Office Suites  
 Seating  
 Tables & Desks  
 Meeting Essentials  
 Personal Organization  
 Ergonomics  
 High Density Storage  
 Storage & Filing  
 Facilities  
 Technology Furniture  
 Art & Engineering  
 K-12 Education  
 SAFE Collection Addendum



## Machine Stands

Model #	Description	Model #	List Price Ea.	List Carton Price	Quantity Per Carton	Actual Weight	S-Parcel Billable Weight	Carton Cube	Freight Class
	<b>1876</b> Machine Stand with Drop Leaves Overall Size: 20" - 36" W x 18" D x 26 3/4" H Finish: Black-BL	1876BL	326.00	326.00	1	21	21	1.07	70
	<b>5206</b> UnderDesk Printer/Fax Stand Overall Size: 19" W x 16" D x 13 1/2" H Four Casters (Two Locking) Finish: Black-BL, Gray-GR	5206BL 5206GR	182.00	182.00	1	17	17	0.94	70
	<b>5207</b> Desk Side Wire Machine Stand Overall Size: 24" W x 20" D x 27" H Four Casters (Two Locking) Finish: Black-BL, White-WH	5207BL 5207WH	262.00	262.00	1	33	34	1.91	70

### Onyx™ UnderDesk Machine Stand

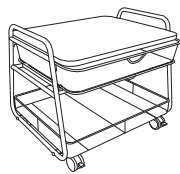

**5208** Onyx™ UnderDesk Machine Stand  
Overall Size: 21" W x 16" D x 17 1/2" H  
Printer Stand Top: 21" W x 16" D  
Slide-Out Drawer: 21" W x 16" D x 3 1/2" H  
Finish: Black-BL, White-WH

5208BL  
5208WH

342.00 342.00

1 23 32 2.96 125

### Rolling Storage Carts

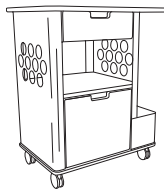

**5202WH** Rolling Storage Cart  
Overall Size: 28" W x 20" D x 33 1/2" H  
Work Surface: 28" W x 20" D  
Slide-Out Drawers: 15 1/4" W x 15 1/4" D x 5" H  
15 1/4" W x 15 1/4" D x 13 3/4" H  
Side Compartment: 5 1/2" W x 17 1/2" D x 7" H  
Finish: Silver Frame with White Top-WH

5202WH

989.00 989.00

1 98.20 103 9.88 70

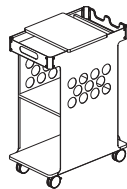

**5209WH** Mini Rolling Storage Cart  
Overall Size: 15" W x 25 1/4" D x 34 1/2" H  
Finish: Silver Frame with White Top-WH

5209WH

548.00 548.00

1 45 46 2.82 100



Office Suites  
Seating  
Tables & Desks  
Meeting Essentials  
Personal Organization  
Ergonomics  
High Density Storage  
Storage & Filing  
Facilities  
Technology Furniture  
Art & Engineering  
K-12 Education  
SAFE Collection Addendum

# Wood Desktop Organizers

Safco® Products marketing materials are designed to be used as sales tools for our Dealer network.

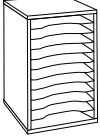
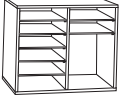
Model #	Description	Model #	List Price Ea.	List Carton Price	Quantity Per Carton	Actual Weight	S-Parcel Billable Weight	Carton Cube	Freight Class
	<b>Desktop Organization</b> <b>9419</b> Wood Desktop Sorter - 11 Compartments Overall Size: 10½"W x 12"D x 16"H <b>Finish:</b> Cherry-CY, Gray-GR, Medium Oak-MO	9419CY 9419GR 9419MO	129.00	129.00	1	11	12	0.47	85
	<b>9420</b> Wood Vertical Adj. Lit. Organizer - 12 Compartments Overall Size: 19½"W x 12"D x 16"H <b>Finish:</b> Cherry-CY, Gray-GR, Medium Oak-MO	9420CY 9420GR 9420MO	135.00	135.00	1	17	18	0.56	85

# Plastic Desk Accessories

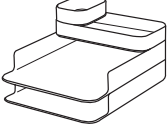
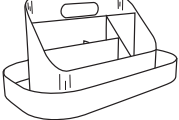
	<b>Stacking Plastic Desktop Sorter Set</b> <b>3285</b> Stacking Plastic Desktop Sorter Set Overall Size: 7"W x 12½"D x 7½"H <b>Four Piece Set includes:</b> Large Tray, Small Tray and 2 Letter Sorters Each part is stackable. <b>Finish:</b> Black-BL, White-WH	3285BL 3285WH	75.00	75.00	1	4	4	0.33	70
	<b>3286</b> Mobile Caddy Letter Tray: 12½"W x 2"D x 10"H Large Tray: 10"W x 1½"D x 4½"H Small Tray: 3"W x ½"D x 4½"H Overall Size: 12½"W x 7½"D x 8½"H <b>Finish:</b> Black-BL, White-WH	3286BL 3286WH	75.00	75.00	1	2.5	5	0.43	150

Office Suites  
Seating  
Tables & Desks  
Meeting Essentials  
Personal Organization  
Ergonomics  
High Density Storage  
Storage & Filing  
Facilities  
Technology Furniture  
Art & Engineering  
K-12 Education  
SAFE Collection Addendum

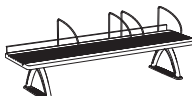
Model #	Description	Model #	List Price Ea.*	List Carton Price	Quantity Per Carton	Actual Weight	S-Parcel Billable Weight	Carton Cube	Freight Class
	<b>Desktop Risers</b> 3603BL 42" Desk Riser 42"W x 12½"D x 8¼"H Finish: Black-BL	3603BL	336.00	336.00	1	17	18	1.18	70





Onyx™ Desktop Organizers

	<b>Onyx™ Mesh Literature Organizers</b> 9430BL Onyx™ Mesh Literature Organizer - 12 Compartments 30"W x 12½"D x 11¼"H Finish: Black-BL	9430BL	250.00	250.00	1	19	32	2.82	70
	9431BL Onyx™ Mesh Literature Organizer - 6 Compartments 10¼"W x 12½"D x 15¼"H Finish: Black-BL	9431BL	154.00	154.00	1	10	14	1.37	70
	9432BL Onyx™ Mesh Literature Organizer - 5 Drawers 10¼"W x 12½"D x 15¼"H Finish: Black-BL	9432BL	187.00	187.00	1	14	15	1.37	70
	<b>Onyx™ Stackable Mesh Storage Bin</b> 2164BL Onyx™ Stackable Mesh Storage Bin 14"W x 15½"D x 11¼"H Finish: Black-BL	2164BL	95.00	95.00	1	6	6	0.44	150

Office Suites  
Seating  
Tables & Desks  
Meeting Essentials  
Personal Organization  
Ergonomics  
High Density Storage  
Storage & Filing  
Facilities  
Technology Furniture  
Art & Engineering  
K-12 Education  
SAFE Collection Addendum

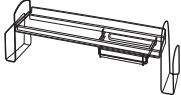
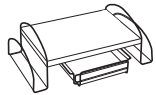
# Onyx™ Desktop Organizers

Safco® Products marketing materials are designed to be used as sales tools for our Dealer network.

Model #	Description	Model #	List Price Ea.*	List Carton Price	Quantity Per Carton	Actual Weight	S-Parcel Billable Weight	Carton Cube	Freight Class	
 <b>3604BL</b>	Onyx™ Mesh Off-Surface Shelf 31½"W x 7¾"D x 10"H <b>Finish: Black-BL</b>	3604BL	109.00	109.00	1	5	6	0.52	70	
 <b>2159BL</b>	Onyx™ Mesh Monitor Stand 19¾"W x 11¾"D x 6¼"H <b>Finish: Black-BL</b>	2159BL	105.00	105.00	1	5.6	11	0.95	70	
 <b>2160BL</b>	Onyx™ Mesh Telephone Stand 11¾"W x 9¾"D x 7"H <b>Finish: Black-BL</b>	2160BL	59.00	59.00	1	1	2.6	2.68	175	
 <b>2161BL</b>	Onyx™ Mesh Laptop Stand 12¾"W x 12¾"D x 2"H <b>Finish: Black-BL</b>	2161BL	50.00	50.00	1	2	2.4	1.5	925	
<b>Onyx™ Mesh Organizers</b>										
 <b>3250BL*</b>	Onyx™ Mini Steel Mesh Organizer 6"W x 5¼"D x 5¼"H <b>Finish: Black-BL</b> <b>* Only available to order by Carton.</b>	3250BL	43.00	258.00	6	9	10	0.93	150	
 <b>3251BL*</b>	Onyx™ Deluxe Steel Mesh Organizer 12¾"W x 5¼"D x 5¼"H <b>Finish: Black-BL</b> <b>* Only available to order by Carton.</b>	3251BL	45.00	270.00	6	14	20	1.9	150	
 <b>3252BL</b>	Onyx™ Steel Mesh Organizer with 3 Drawers 16"W x 11½"D x 8¼"H <b>Finish: Black-BL</b>	3252BL	100.00	100.00	1	7	12	1.08	150	

# Onyx™ Power Mesh Desktop Organizers

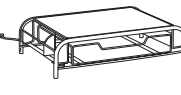
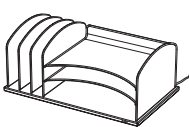
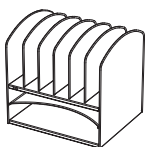
<b>Onyx™ Power Mesh Desktop Organizers</b>										
 <b>3230BL</b>	Onyx™ Power Mesh Monitor Stand 18"W x 11¾"D x 4¾"H <b>Finish: Black-BL</b>	3230BL	132.00	132.00	1	5	8	0.72	70	
 <b>3231BL</b>	Onyx™ Power Mesh Desk Organizer 3 Horizontal/3 Upright Sections 19½"W x 11½"D x 8¼"H <b>Finish: Black-BL</b>	3231BL	132.00	132.00	1	8	14	1.24	70	
 <b>3233BL</b>	Onyx™ Power Mesh Desk Organizer 2 Horizontal/6 Upright Sections 13¾"W x 11½"D x 13"H <b>Finish: Black-BL</b>	3233BL	145.00	145.00	1	10	14	1.41	70	



Office Suites  
Seating  
Tables & Desks  
Meeting Essentials  
Personal Organization  
Ergonomics  
High Density Storage  
Storage & Filing  
Facilities  
Technology Furniture  
Art & Engineering  
K-12 Education  
SAFE Collection Addendum

## Onyx™ Mesh Hanging Storage Organizers

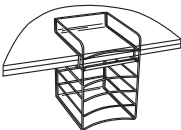
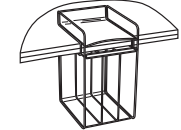
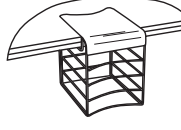
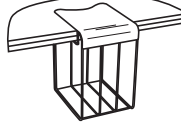
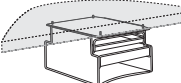
Model #	Description	Model #	List Price Ea.	List Carton Price	Quantity Per Carton	Actual Weight	S-Parcel Billable Weight	Carton Cube	Freight Class
<b>Onyx™ Mesh Hanging Storage Organizers</b>									
	<b>3240BL</b> Onyx™ Mesh Horizontal Hanging Storage 5 Horizontal Sections 10½"W x 12½"D x 14½"H Finish: Black-BL	3240BL	95.00	95.00	1	6	14	1.28	150
	<b>3241BL</b> Onyx™ Mesh Vertical Hanging Storage 1 Horizontal/3 Vertical Sections 10½"W x 12"D x 17½"H Finish: Black-BL	3241BL	97.00	97.00	1		17	1.47	150
	<b>3242BL</b> Onyx™ Mesh Solid Top Horizontal Hanging Storage 4 Horizontal Sections 10½"W x 12½"D x 12"H Finish: Black-BL	3242BL	86.00	86.00	1	7	12	1.08	150
	<b>3243BL</b> Onyx™ Mesh Solid Top Vertical Hanging Storage 3 Vertical Sections 9½"W x 12"D x 14½"H Finish: Black-BL	3243BL	86.00	86.00	1	7	13	1.21	150
	<b>3244BL</b> Onyx™ Mesh Mountable Hanging Storage 1 Horizontal Section/Pull Out Drawer 10½"W x 12½"D x 7½"H Finish: Black-BL	3244BL	84.00	84.00	1	6	7	0.7	150



## Onyx™ Mesh Desktop Organizers

<b>Onyx™ Mesh Organizers</b>									
	<b>3253BL</b> Onyx™ Mesh Desk Organizer - 8 Upright Sections 19¾"W x 11½"D x 8¾"H Finish: Black-BL	3253BL	99.00	99.00	1	8	14	1.3	150
	<b>3254</b> Onyx™ Mesh Desk Organizer 3 Horizontal/3 Upright Sections 19¾"W x 11½"D x 8¾"H Finish: Black-BL, Blue-BU, White-WH, Wine-WE	3254BL 3254BU 3254WH 3254WE	101.00	101.00	1	7	14	1.18	150
	<b>3255</b> Onyx™ Mesh Desk Organizer 2 Horizontal/6 Upright Sections 13¾"W x 11½"D x 13"H Finish: Black-BL, Blue-BU, White-WH, Wine-WE	3255BL 3255BU 3255WH 3255WE	111.00	111.00	1	9	15	1.36	150
	<b>3256BL</b> Onyx™ Mesh Desk Organizer - 5 Upright Sections 12½"W x 11½"D x 8¾"H Finish: Black-BL	3256BL	69.00	69.00	1	5	11	0.86	150
	<b>3257BL</b> Onyx™ Mesh Desk Organizer - 5 Tiered Sections 11¾"W x 7¾"D x 12"H Finish: Black-BL	3257BL	81.00	81.00	1	5	8	0.71	150
	<b>3258</b> Onyx™ Mesh Desk Organizer - 8 Tiered Sections 11¾"W x 10½"D x 14"H Finish: Black-BL, White	3258BL 3258WH	99.00	99.00	1	7	7	1.14	150
	<b>3259BL</b> Onyx™ Mesh Desk Hanging File with 2 Upright Sections 19¾"W x 11½"D x 11½"H Finish: Black-BL	3259BL	107.00	107.00	1	7	17	1.64	150

Office Suites  
Seating  
Tables & Desks  
Meeting Essentials  
Personal Organization  
Ergonomics  
High Density Storage  
Storage & Filing  
Facilities  
Technology Furniture  
Art & Engineering  
K-12 Education  
SAFE Collection Addendum

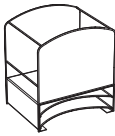
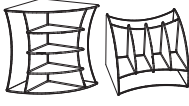
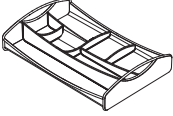
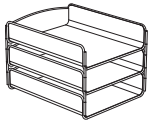
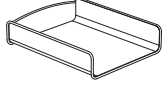
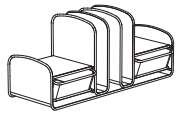
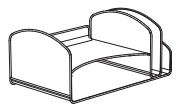
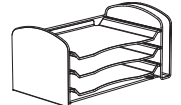

# Onyx™ Mesh Desktop Organizers

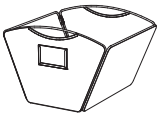
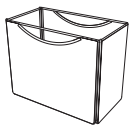
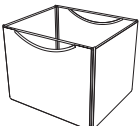
Safco® Products marketing materials are designed to be used as sales tools for our Dealer network.

Model #	Description	Model #	List Price Ea.*	List Carton Price	Quantity Per Carton	Actual Weight	S-Parcel Billable Weight	Carton Cube	Freight Class
<b>Onyx™ Mesh Desk Organizers</b>									
 3260BL	Onyx™ Mesh Desk Hanging File with 2 Horizontal Sorters 13½"W x 10¾"D x 15½"H Finish: Black-BL	3260BL	100.00	100.00	1	7	17	1.49	150
 3261BL	Onyx™ Mesh Desk Corner Organizer 15"W x 11"D x 13"H Can be used Vertically or Horizontally Finish: Black-BL	3261BL	93.00	93.00	1	4	3	1.07	150
 3262BL	Onyx™ Mesh Drawer Organizer 13"W x 8¾"D x 2¼"H Finish: Black-BL	3262BL	68.00	68.00	1	2	3	0.25	70
 3271	Onyx™ Mesh Triple Tray Organizer 9¾"W x 11¾"D x 8"H Finish: Black-BL, Blue-BU, White-WH, Wine-WE	3271BL 3271BU 3271WH 3271WE	71.00	71.00	1	3	6	0.5	70
 3272BL*	Onyx™ Mesh Single Tray Organizer 9¾"W x 11¾"D x 2½"H Finish: Black-BL * Only available to order by Carton.	3272BL	27.00	162.00	6	8	19	1.66	70
 3263BL	Onyx™ Mesh Multi-Purpose Desk Organizer 3 Upright/2 Drawers 17"W x 6¾"D x 7¾"H Finish: Black-BL	3263BL	77.00	77.00	1	4	8	0.65	70
 3264BL	Onyx™ Mesh Desk Organizer 2 Horizontal/2 Upright Sections 17"W x 10¾"D x 7¾"H Finish: Black-BL	3264BL	79.00	79.00	1	4	11	0.98	70
 3265BL	Onyx™ Mesh Desk Organizer 1 Upright/3 Sliding Horizontal Sections 16¾"W x 9"D x 8"H Finish: Black-BL	3265BL	92.00	92.00	1	5	10	0.83	70
 3266	Onyx™ Mesh Desk Organizer 3 Horizontal/5 Upright Sections 11½"W x 9½"D x 13"H Finish: Black-BL, White-WH	3266BL 3266WH	105.00	105.00	1	8	11	0.99	70
<b>Onyx™ Mesh Desktop Tub and Box File Organizers</b>									
 2162BL	Onyx™ Mesh Desktop Tub File Organizer, Letter-Size 12½"W x 13¾"D x 9½"H Finish: Black-BL	2162BL	66.00	66.00	1	2	2.6	0.93	175
 2169BL*	Onyx™ Mesh Desktop Box File Organizer 12½"W x 7"D x 10"H Finish: Black-BL * Only available to order by Carton.	2169BL	46.00	276.00	6	16	16	1.16	150
 2170BL*	Onyx™ Mesh Desktop Box File Organizer 12½"W x 11"D x 10"H Finish: Black-BL * Only available to order by Carton.	2170BL	57.00	342.00	6	18	19	1.04	150

Office Suites  
Seating  
Tables & Desks  
Meeting Essentials  
Personal Organization  
Ergonomics  
High Density Storage  
Storage & Filing  
Facilities  
Technology Furniture  
Art & Engineering  
K-12 Education  
SAFE Collection Addendum

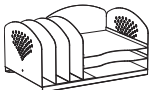
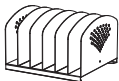
## Steel Combination Desk Organizers

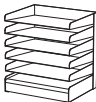
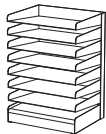
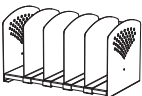





Model #	Description	Model #	List Price Ea.	List Carton Price	Quantity Per Carton	Actual Weight	S-Parcel Billable Weight	Carton Cube	Freight Class
<b>Steel Combination Desk Organizers</b>									
	<b>3167BL</b> Combination Steel Desk Rack 3 Upright/3 Horizontal Sections 16¼"W x 11¼"D x 8¼"H Finish: Black-BL	3167BL	110.00	110.00	1	10	12	1.18	70
	<b>3155BL</b> Six Section Steel Desk Rack 12¼"W x 11¼"D x 8"H Finish: Black-BL	3155BL	79.00	79.00	1	7	9	0.87	70
<b>Steel Desktop Organizer</b>									
<b>Steel Desk Organizers</b>									
	<b>3127BL</b> Steel Desk Tray - 5 Tier 12"W x 9½"D x 11¼"H Finish: Black-BL	3127BL	92.00	92.00	1	8	17	1.52	70
	<b>3128BL</b> Steel Desk Tray - 6 Tier 12"W x 9½"D x 13¼"H Finish: Black-BL	3128BL	100.00	100.00	1	8	18	1.7	70
	<b>3129BL</b> Steel Desk Tray - 8 Tier 12"W x 9½"D x 17¼"H Finish: Black-BL	3129BL	159.00	159.00	1	11	22	2.13	70
<b>Steel Book Storage</b>									
	<b>3116BL</b> Adjustable Book Rack - 5 Sections 15½"W x 9"D x 9¼"H Finish: Black-BL	3116BL	133.00	133.00	1	9	11	0.93	110

Office Suites  
Seating  
Tables & Desks  
Meeting Essentials  
Personal Organization  
Ergonomics  
High Density Storage  
Storage & Filing  
Facilities  
Technology Furniture  
Art & Engineering  
K-12 Education  
SAFE Collection Addendum

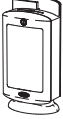

# Suggestion Boxes

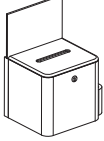
Safco® Products marketing materials are designed to be used as sales tools for our Dealer network.

Model #	Description	Model #	List Price Ea.	List Carton Price	Quantity Per Carton	Actual Weight	S-Parcel Billable Weight	Carton Cube	Freight Class
<b>Suggestion Boxes</b>									
	<b>4231*</b> Suggestion Box Card Refill Pack for 4230, 4232 & 4233 * Only available to order by Carton.	4231	12.00	720.00	60	10	10	0.25	775
	<b>4232BL</b> Steel Suggestion Box Overall Size: 7¼"W x 6"D x 8½"H Deposit Slot: 4¼ x ½" Comes with 25 Suggestion Cards Finish: Black-BL	4232BL	110.00	110.00	1	4	4	0.3	85
	<b>4233GR</b> Customizable Suggestion Box Overall Size: 7"W x 5"D x 14½"H Comes with 25 Suggestion Cards Finish: Gray-GR	4233GR	121.00	121.00	1	3	5	0.36	100
	<b>4234CL</b> Large Acrylic Collection Box with Lock Overall Size: 9¼"W x 9¼"D x 21"H 5¼" W x ½" Slot in top allows for multiple sized slips Finish: Clear-CL	4234CL	155.00	155.00	1	7	18	1.54	175
	<b>Bamboo Suggestion Box</b> <b>4237</b> Bamboo Suggestion Box Overall Size: 10"W x 8"D x 14"H Comes with 25 Suggestion Cards Finish: Cherry-CY, Natural-NA	4237CY 4237NA	139.00	139.00	1	6	9	0.8	125
	<b>4258BL</b> Interoffice Mailbox, Steel Overall Size: 12"W x 3"D x 12"H Finish: Black-BL	4258BL	110.00	110.00	1	6	7	0.63	70
	<b>4259BL</b> Interoffice Mailbox, Steel Overall Size: 18"W x 7"D x 18"H Finish: Black-BL	4259BL	158.00	158.00	1	14	23	2.24	70





Office Suites  
Seating  
Tables & Desks  
Meeting Essentials  
Personal Organization  
Ergonomics  
High Density Storage  
Storage & Filing  
Facilities  
Technology Furniture  
Art & Engineering  
K-12 Education  
SAFE Collection Addendum

Model #	Description	Model #	List Price Ea.	List Carton Price	Quantity Per Carton	Actual Weight	S-Parcel Billable Weight	Carton Cube	Freight Class
	<b>PanelMate® Organizers</b> <b>4158CH*</b> PanelMate® Dry Erase Board 13½"W x 1¾"D x 16¾"H Finish: Charcoal-CH * Only available to order by Carton.	4158CH	88.00	528.00	6	21	31	2.86	70

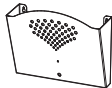
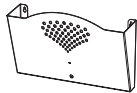
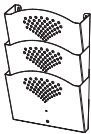
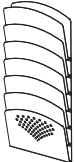
Steel - Wall Pocket Organizers

Model #	Description	Model #	List Price Ea.	List Carton Price	Quantity Per Carton	Actual Weight	S-Parcel Billable Weight	Carton Cube	Freight Class
	<b>Steel Wall Pocket Organizers</b> <b>3170BL</b> Steel Wall File, Letter-Size 12"W x 3"D x 9" Finish: Black-BL	3170BL	46.00	46.00	1	3	3	0.27	100
	<b>3171BL</b> Steel Wall File, Legal-Size 15"W x 3"D x 9" Finish: Black-BL	3171BL	56.00	56.00	1	3	4	0.35	100
	<b>3172BL</b> Steel Wall File, Triple Letter-Size 12"W x 3¾"D x 17¾"H Finish: Black-BL	3172BL	108.00	108.00	1	8	8	0.61	100
	<b>3185BL</b> Steel Wall Seven Pocket Letter/Legal-Size Rack 9¾"W x 2"D x 21¾"H Finish: Black-BL	3185BL	106.00	106.00	1	7	7	0.59	110

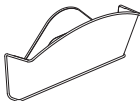

Onyx™ Mesh - Wall Organizers

Model #	Description	Model #	List Price Ea.	List Carton Price	Quantity Per Carton	Actual Weight	S-Parcel Billable Weight	Carton Cube	Freight Class
	<b>Onyx™ Mesh Wall Organizers</b> <b>5651BL*</b> Onyx™ Mesh Letter-Size Rack 12"W x 3"D x 9" Finish: Black-BL * Only available to order by Carton.	5651BL	41.00	246.00	6	11	21	1.92	70
	<b>5652BL*</b> Onyx™ Mesh Triple Letter-Size Rack 12"W x 3¾"D x 17¾"H Finish: Black-BL	5652BL	92.00	92.00	1	5	4.4	2.83	250
	<b>5653BL</b> Onyx™ Mesh Legal-Size Rack 15"W x 3"D x 9" Finish: Black-BL * Only available to order by Carton.	5653BL	46.00	276.00	6	13	27	2.4	70



Office Suites  
Seating  
Tables & Desks  
Meeting Essentials  
Personal Organization  
Ergonomics  
High Density Storage  
Storage & Filing  
Facilities  
Technology Furniture  
Art & Engineering  
K-12 Education  
SAFE Collection Addendum

# Onyx™ Magnetic Mesh Panel Organizers

Safco® Products marketing materials are designed to be used as sales tools for our Dealer network.

	Model #	Description	Model #	List Price Ea.*	List Carton Price	Quantity Per Carton	Actual Weight	S-Parcel Billable Weight	Carton Cube	Freight Class
	<b>Onyx™ Magnetic Mesh Panel Organizers</b>									
	<b>4175BL*</b>	Onyx™ Magnetic Mesh Triple Pocket File 13"W x 4¼"D x 13½"H <b>Finish: Black-BL</b>	4175BL	101.00	101.00	1	3.2	4.2	3.79	100
	<b>Onyx™ Magnetic Mesh Panel Organizers</b>									
	<b>4176BL*</b>	Onyx™ Magnetic Mesh Single Pocket File 13"W x 4"D x 7¼"H <b>Finish: Black-BL</b> * Only available to order by Carton.	4176BL	44.00	264.00	6	11	30	2.78	100

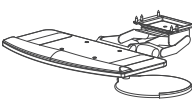

Office Suites  
Seating  
Tables & Desks  
Meeting Essentials  
Personal Organization  
Ergonomics  
High Density Storage  
Storage & Filing  
Facilities  
Technology Furniture  
Art & Engineering  
K-12 Education  
SAFE Collection Addendum

Model #	Description	Model #	List Price Ea.	List Carton Price	Quantity Per Carton	Actual Weight	S-Parcel Billable Weight	Carton Cube	Freight Class
 <b>195TKLS</b>	Trackless Keyboard/Mouse Platform 19"W x 9¼"D, (9½" Dia. Mouse Platform) <b>Finish: Black-SB or White-SW</b>	195TKLS	859.00	859.00	1	14	14	0.0	100
 <b>2150BL</b>	Keyboard/Mouse Platform 19"W x 9¼"D, (9½" Dia. Mouse Platform) <b>Finish: Black-BL</b>	2150BL	845.00	845.00	1	14	14	0.0	100

**Height-Adjustable Keyboard Mechanism**



**Data Center Keyboard Mechanisms**

Please contact Customer Care for compatibility on rectangular and corner workstations to ensure proper fit.

 <b>49263</b>	Data Center 19" W	49263	1,313.00	1,313.00	1	22	22	1.72	70
 <b>49264</b>	Data Center 26¼" W	49264	1,313.00	1,313.00	1	22	22	1.65	70
 <b>49265</b>	Data Center 30-45" adjustable in .98" increments	49265	1,313.00	1,313.00	1	22	22	1.72	70

**Monitor Stands**

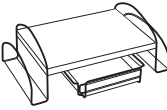
**Onyx™ Monitor Stands**

 <b>2159BL</b>	Onyx™ Mesh Monitor Stand 19¼"W x 11¼"D x 6¼"H <b>Finish: Black-BL</b>	2159BL	105.00	105.00	1	6	11	0.95	70
 <b>2161BL</b>	Onyx™ Mesh Laptop Stand 12¼"W x 12¼"D x 2"H <b>Finish: Black-BL</b>	2161BL	50.00	50.00	1	2	2.4	1.5	925

**CPU Holders**



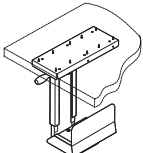
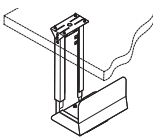







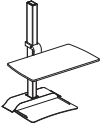

**CPU Holders**

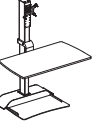
 <b>2175</b>	Ergo-Comfort® Swivel CPU Holder 9" - 13"W x 13¼"D x 17¼" - 23¼"H <b>Finish: Black</b>	2175	331.00	331.00	1	15	15	0.5	70
 <b>2176</b>	Ergo-Comfort® Fixed CPU Holder 7" - 11"W x 9½"D x 14" - 22½"H <b>Finish: Black</b>	2176	232.00	232.00	1	10	10	0.44	70

Office Suites  
Seating  
Tables & Desks  
Meeting Essentials  
Personal Organization  
Ergonomics  
High Density Storage  
Storage & Filing  
Facilities  
Technology Furniture  
Art & Engineering  
K-12 Education  
SAFE Collection Addendum

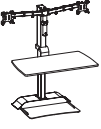

# Soar™ by Safco Electric Desktop Sit/Stand Desk

Safco® Products marketing materials are designed to be used as sales tools for our Dealer network.

Model #	Description	Model #	List Price Ea.*	List Carton Price	Quantity Per Carton	Actual Weight	S-Parcel Billable Weight	Carton Cube	Freight Class
<b>Soar™ by Safco Electric Desktop Sit/Stand Desks</b>									
	<b>2191WH</b> Soar™ by Safco Electric Desktop Sit/Stand Overall: 27¼"W x 22"D x 18½ - 36"H Finish: White-WH   	2191WH	1,189.00	1,189.00	1	46.2	Y	47	3.1
	<b>2192WH</b> Soar™ by Safco Electric Desktop Sit/Stand, One Monitor Arm Overall: 27¼"W x 22"D x 18½ - 36"H Finish: White-WH   	2192WH	1,294.00	1,294.00	1	49.5	Y	50	3.1
	<b>2193WH</b> Soar™ by Safco Electric Desktop Sit/Stand, Dual Monitor Arms Overall: 27¼"W x 22"D x 18½ - 37¼"H Finish: White-WH   	2193WH	1,248.00	1,248.00	1	52.6	Y	53	3.46

## Desktop Sit/Stand Workstations



**2180** Height-Adjustable Laptop Stand  
27"W x 18"D x 21½"H  
Finish: Black-BL  
  

2180BL 267.00 267.00 1 21 21 1.37 70



These products are subject to California Proposition 65. Please visit the product detail page on our website for specific information.



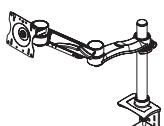
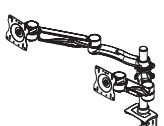

Office Suites  
Seating  
Tables & Desks  
Meeting Essentials  
Personal Organization  
Ergonomics  
High Density Storage  
Storage & Filing  
Facilities  
Technology Furniture  
Art & Engineering  
K-12 Education  
SAFE Collection Addendum

Model #	Description	Model #	List Price Ea.*	List Carton Price	Quantity Per Carton	Actual Weight	S-Parcel Billable Weight	Carton Cube	Freight Class
<b>Pole Mounted Monitor Arms</b>									
 <b>EZKC1</b>	Single Arm Monitor Mount 24" of reach and 18" of usable height adjustment (including pole) 4-20 lb. maximum load per each monitor arm Quick connect monitor screen feature <b>Finish: Silver</b>	EZKC1	878.00	878.00	1	8	9	0.02	100
 <b>EZKC2</b>	Dual Arm Monitor Mount 24" of reach and 18" of usable height adjustment (including pole) 4-20 lb. maximum load per each monitor arm Quick connect monitor screen feature <b>Finish: Silver</b>	EZKC2	1,334.00	1,334.00	1	12	13	0.02	100
<b>Note:</b> Grommet Mount/field installed by installation team.									

## TV Mount



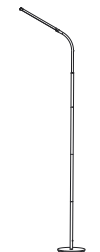

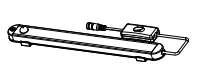
 <b>2144BL</b>	TV Mount 24" of reach and 18" of usable height adjustment (including pole) 4-20 lb. maximum load per each monitor arm Quick connect monitor screen feature <b>Finish: Black</b>	2144BL	149.00	149.00	1	8.8	9	0.63	925
---	---	--------	--------	--------	---	-----	---	------	-----

## LED Lighting

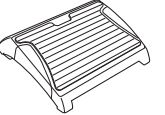
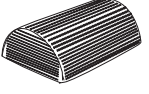

<b>LED Lighting</b>									
 <b>1001</b>	Vamp™ LED Light 5"W x 16"D x 16¼"H <b>Finish: Black-BL, Silver-SL, White-WH</b>	1001BL 1001SL 1001WH	190.00	190.00	1	3	4	0.23	85
 <b>1009</b>	Vamp™ LED Desk Lamp with Wireless Charging 5"W x 16"D x 16¼"H <b>Finish: Black-BL, Silver-SL, White-WH</b>	1009BL 1009SL 1009WH	220.00	220.00	1	2.6	3	0.15	85
<b>LED Task Lighting – Under Cabinet (Basic)</b>									
 <b>EZDP</b>	Under Cabinet LED Light 16"W <b>Finish: Silver</b>	EZDP	337.00	337.00	1	1	4	.26	250
<b>Resi™ LED Lighting</b>									
 <b>1017</b>	Resi™ Gooseneck LED Floor Lamp with 9 Hour Shut Off Delay 8"W x 8"D x 60"H <b>Finish: Black-BL, White-WH</b>	1017BL 1017WH	289.00	289.00	1	4	10	-	60
 <b>1018</b>	Resi™ Gooseneck LED Desk Lamp with 30-Minute Occupancy Sensor 5"W x 5"D x 18½"H <b>Finish: Black-BL, White-WH</b>	1018BL 1018WH	218.00	218.00	1	2	5	-	60
 <b>1019WH</b>	Resi™ Magnetic Under Cabinet LED Light with 30-Minute Occupancy Sensor 17½"W x 1¼"D x 1"H <b>Finish: White-WH</b>	1019WH	112.00	112.00	1	0.5	2	-	60

# Footrests

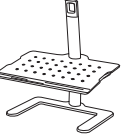
Safco® Products marketing materials are designed to be used as sales tools for our Dealer network.

Model #	Description	Model #	List Price Ea.	List Carton Price	Quantity Per Carton	Actual Weight	S-Parcel Billable Weight	Carton Cube	Freight Class
<b>Footrests</b>									
 <b>2105</b>	Ergo-Comfort® Footrest - 5" High 18½"W x 11½"D x 5"H Finish: Black * Only available to order by Carton.	2105	93.00	465.00	5	26	59	5.63	85
 <b>2106</b>	Ergo-Comfort® Footrest - 8" High 18½"W x 11½"D x 8"H Finish: Black * Only available to order by Carton.	2106	109.00	436.00	4	24	74	6.98	85
 <b>2120BL</b>	Restease™ Adjustable Footrest 15½"W x 14¾"D x 3¾" to 5"H Finish: Black-BL * Only available to order by Carton.	2120BL	83.00	415.00	5	20	28	2.74	150
 <b>92311</b>	Remedease® Foot Cushion 17½"W x 11½"D x 6¾"H Finish: Black * Only available to order by Carton.	92311	75.00	375.00	5	8	47	4.27	300
 <b>5124</b>	Task Master® Adjustable Footrest Overall: 20"W x 12"D x 5½" - 15"H Finish: Black	5124	323.00	323.00	1	14	14	0.86	85
 <b>2129</b>	Shift™ Height-Adjustable Footrest Platform: 20"W x 12"D Overall: 20½"W x 14¾"D x 21½"H Finish: Black	2129BL	246.00	246.00	1	18	19	1.23	100

Office Suites  
Seating  
Tables & Desks  
Meeting Essentials  
Personal Organization  
**Ergonomics**  
High Density Storage  
Storage & Filing  
Facilities  
Technology Furniture  
Art & Engineering  
K-12 Education  
SAFE Collection Addendum





Model #	Description	Model #	List Price Ea.*	List Carton Price	Quantity Per Carton	Actual Weight	S-Parcel Billable Weight	Carton Cube	Freight Class
	<b>Safco® Movable Anti-Fatigue Mat</b> <b>2110BL</b> Safco® Movable Anti-Fatigue Mat Overall: 30"W x 20"D x 1"H Finish: Black	2110BL	125.00	125.00	1	5	8	0.56	125
	<b>2111BL</b> Safco® Large Movable Anti-Fatigue Mat Overall: 36"W x 24"D x 1"H Finish: Black	2111BL	230.00	230.00	1	8	12	0.8	100



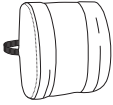
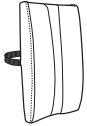

# Backrests

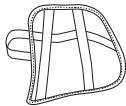
Safco® Products marketing materials are designed to be used as sales tools for our Dealer network.

Model #	Description	Model #	List Price Ea.*	List Carton Price	Quantity Per Carton	Actual Weight	S-Parcel Billable Weight	Carton Cube	Freight Class
 <b>71491</b>	Remedease® High Profile Backrest 12½"W x 4"D x 13"H Finish: Black * Only available to order by Carton.	71491	76.00	380.00	5	6	24	2.27	250
 <b>71301</b>	Remedease® Full Height Backrest 14"W x 3"D x 19½"H Finish: Black * Only available to order by Carton.	71301	94.00	470.00	5	5	28	2.48	250
 <b>7152BL</b>	SoftSpot® Seat Cushion 15½"W x 10"D x 3"H Finish: Black-BL * Only available to order by Carton.	7152BL	127.00	635.00	5	10	23	2.1	150
 <b>7153BL</b>	Mesh Backrest 17½"W x 3"D x 15"H Finish: Black-BL * Only available to order by Carton.	7153BL	57.00	285.00	5	10	69	6.45	300
 <b>7154BL</b>	Memory Foam Lumbar Support Backrest 14½"W x 3¾"D x 6¾"H Finish: Black-BL * Only available to order by Carton.	7154BL	72.00	360.00	5	13	27	2.39	150

# SoftSpot® Wrist Rest

 <b>90208</b>	SoftSpot® Proline Keyboard Pad 18"W x 3¾"D x 1¼"H Finish: Black-BL * Only available to order by Carton.	90208	58.00	580.00	10	11	11	0.84	85
--	--	-------	-------	--------	----	----	----	------	----



These products are subject to California Proposition 65. Please visit the product detail page on our website for specific information.

Office Suites  
Seating  
Tables & Desks  
Meeting Essentials  
Personal Organization  
Ergonomics  
High Density Storage  
Storage & Filing  
Facilities  
Technology Furniture  
Art & Engineering  
K-12 Education  
SAFE Collection Addendum

**SPACE PLANNING SERVICES**

**Space Planning Services**

Our team of space planning experts provide workspace and storage solution designs that include our entire product offering. Plus, our design renderings showcase how Safco products will fit into your space and bring in color and textures so you can see what your space will look like – making guesswork a thing of the past.

If you have any space planning questions, contact your local Safco Sales Rep Group.

**Certified Installers**

Our certified installers undergo in-depth training on all of our Filing & Storage System products. To find an installer near you visit [www.safcoproducts.com](http://www.safcoproducts.com), Customer Care and click on "Find a Certified Installer".

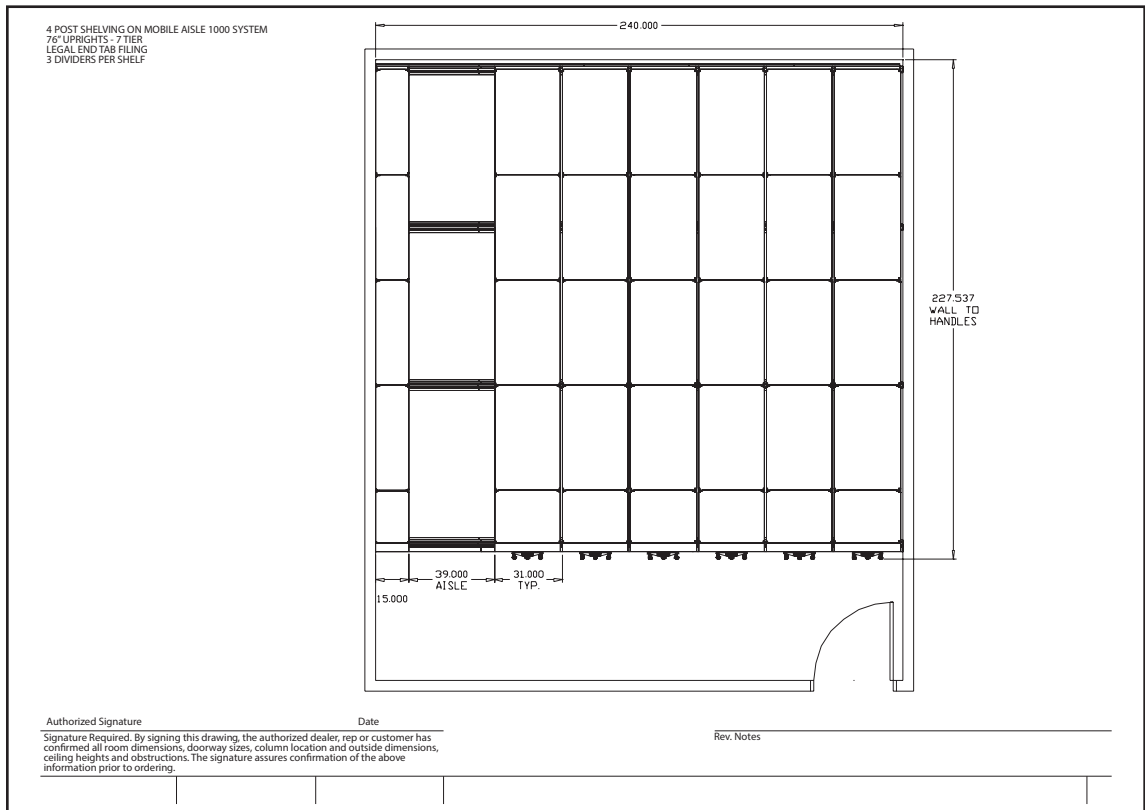
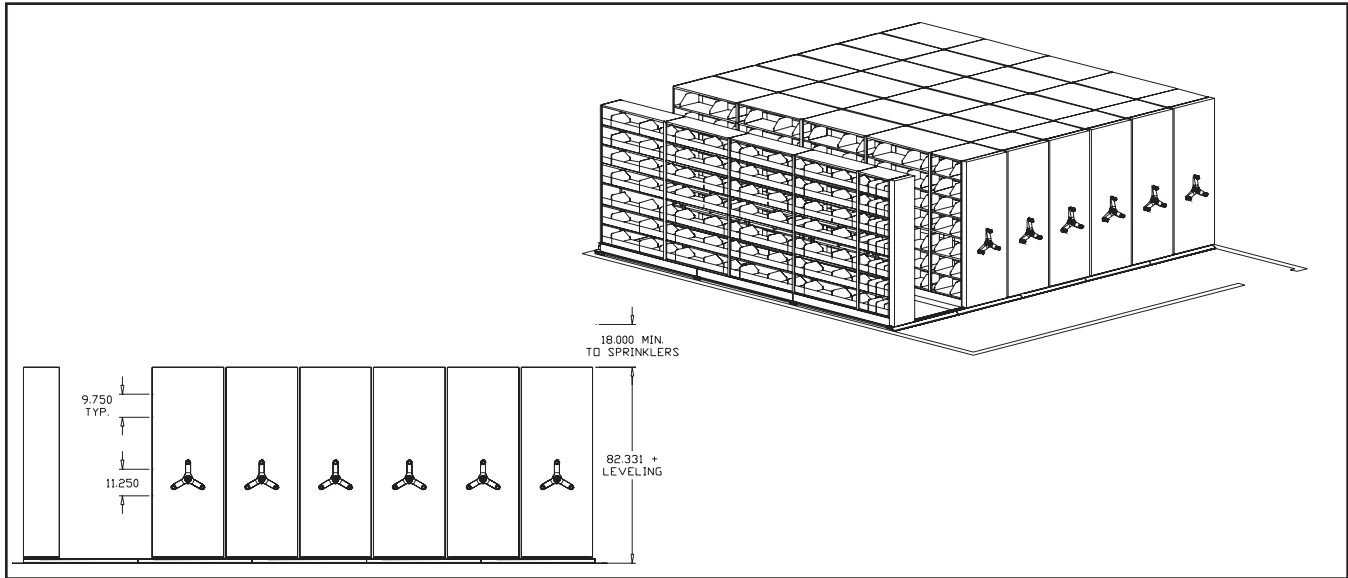

Mobile Aisle 1000™

**4-Post Shelving**

- Hardware included for Mobile Aisle installation
- End panels provide a finished appearance
- All shelving is offered in 24", 30", 36", 42" and 48" widths
- All shelving is offered in 9", 12", 15", 18", 24", 30 and 36" depths
- Dividers interlock with common stop for stability
- 4-Post design shelving will support 240 lbs. per shelf
- Heavy-Duty will support 800 lbs. per shelf
- Accessories: Roll-out drawers, Posting/Reference Shelf, Slatwall
- Wall anchoring brackets and hardware available

**Track, Decking & Ramps**

- Non-grouted track, totally re-levelable at any time
- Levelers in pairs positioned every 6"
- Two point contact to floor for weight load distribution
- Track interlocks and overlaps at all track joints
- Attachment to floor with expansion bolt
- Deck is supplied by Safco®
- Available with fire-retardant carpet (Charcoal or Brown Rouse) or unfinished
- Deck panels – complete with levelers
- Low profile standard system entry or ADA/incline ramp options

**End Panel Drive Assemblies**

- 1 pound of pressure required to move 10,000 lbs.
- All steel, no particleboard
- Painted steel end panels available in standard Safco® Corporate colors, see page 10 or go to Safco website to view color swatches
- Three spoke handle which includes a range safety lock with red locking indicator

If you have any space planning questions, contact your local Safco Sales Rep Group.

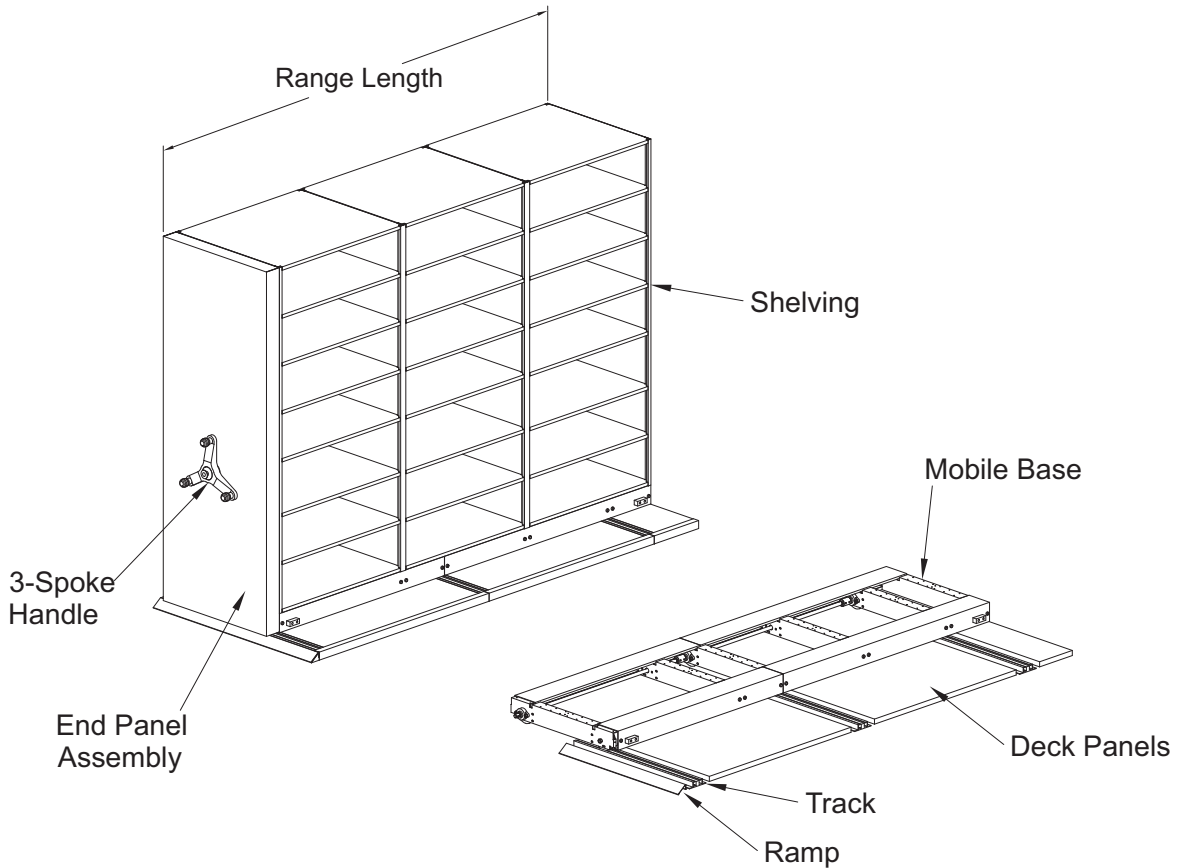

Office Suites  
Seating  
Tables & Desks  
Meeting Essentials  
Personal Organization  
Ergonomics  
High Density Storage  
Storage & Filing  
Facilities  
Technology Furniture  
Art & Engineering  
K-12 Education  
SAFE Collection Addendum

Think of Mobile Lite as the streamlined version of Mobile 1000 – same concept with a few modifications that make it even more affordable and it installs in half the time of larger, heavy-duty systems.

The easy-to-order Mobile Lite typical model numbers include the following: one single faced fixed unit, one single faced movable unit and a range of 2 to 4 double faced movable units. Model numbers also include 7-tier 4-post shelving, back panels for single faced units, dividers, half high end panel assembly, key lock included with single faced movable unit, plunger lock included with all double faced movable units, mobile bases, track and additional track for typical aisle walkway. No decking or ramping required. For special customer requirements and design service, or you have any space planning questions, contact your local Safco Sales Rep Group.

## Mobile Lite Typicals

- Comes with dividers, 3 per shelf
- Letter-size media - 12" Depth

Letter Depth Shelving Model Numbers	System Width	Overall Range Length	Overall Height	Wt.	Aisle	LFI	System Size	List Price
EML3672L	118"	44"	80 <sup>1</sup> / <sub>4</sub> "	1,159	36"	1,454"	10' x 4'	19,377.00
EML3673L	144"	44"	80 <sup>1</sup> / <sub>4</sub> "	1,500	36"	1,939"	12' x 4'	22,865.00
EML3674L	170"	44"	80 <sup>1</sup> / <sub>4</sub> "	1,844	36"	2,424"	15' x 4'	28,043.00
EML4872L	118"	56"	80 <sup>1</sup> / <sub>4</sub> "	1,334	36"	1,958"	10' x 5'	19,951.00
EML4873L	144"	56"	80 <sup>1</sup> / <sub>4</sub> "	1,562	36"	2,611"	12' x 5'	26,603.00
EML4874L	170"	56"	80 <sup>1</sup> / <sub>4</sub> "	2,099	36"	3,263"	15' x 5'	31,581.00
EML7272L	118"	80"	80 <sup>1</sup> / <sub>4</sub> "	1,858	36"	2,912"	10' x 7'	29,624.00
EML7273L	144"	80"	80 <sup>1</sup> / <sub>4</sub> "	2,384	36"	3,884"	12' x 7'	37,938.00
EML7274L	170"	80"	80 <sup>1</sup> / <sub>4</sub> "	2,909	36"	4,854"	15' x 7'	43,767.00
EML9672L	118"	104"	80 <sup>1</sup> / <sub>4</sub> "	2,202	36"	3,916"	10' x 9'	33,139.00
EML9673L	144"	104"	80 <sup>1</sup> / <sub>4</sub> "	2,810	36"	5,222"	12' x 9'	39,878.00
EML9674L	170"	104"	80 <sup>1</sup> / <sub>4</sub> "	3,417	36"	6,527"	15' x 9'	53,291.00

**System Width:** Total length from left to right of system

**Overall Range Length:** From wall to the tip of the handle (dimension includes 1<sup>1</sup>/<sub>2</sub>" clearance from wall)

**Overall Height:** Distance from the floor to the top of shelving

**Aisle:** Walkway between ranges

**LFI:** The amount of Linear Filing Inches offered in each typical

**System Size:** Footprint of the system

### Letter

EML3672L

EML: Mobile Lite

36: Overall shelving length in inches

7: Number of shelves per unit

2: Number of double face movable units

L: Letter media

### Letter

EML4874L

EML: Mobile Lite

48: Overall shelving length in inches

7: Number of shelves per unit

4: Number of double face movable units

L: Letter media

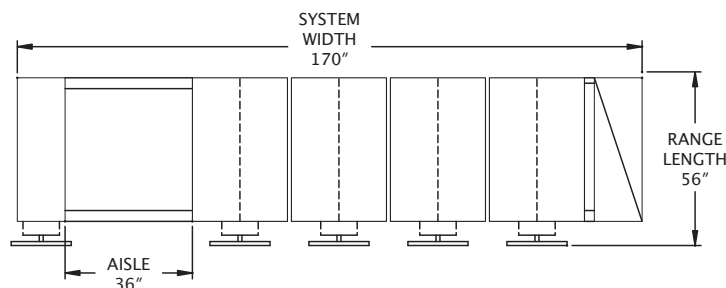
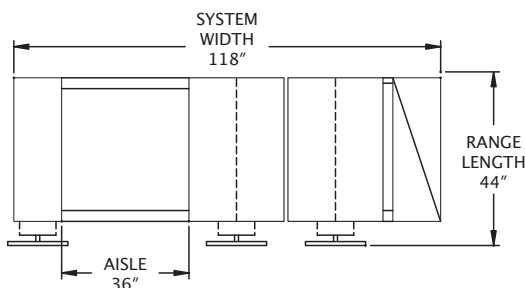

Top View of System Ranges

## Mobile Lite Typicals

- Comes with dividers, 3 per shelf
- Legal-size media - 15" Depth

Legal Depth Shelving Model Numbers	System Width	Overall Range Length	Overall Height	Wt.	Aisle	LFI	System Size	List Price
EML3672G	135"	44"	80 <sup>1</sup> / <sub>4</sub> "	1,337	36"	1,454"	12' x 4'	19,279.00
EML3673G	167"	44"	80 <sup>1</sup> / <sub>4</sub> "	1,745	36"	1,939"	14' x 4'	25,050.00
EML3674G	199"	44"	80 <sup>1</sup> / <sub>4</sub> "	2,153	36"	2,424"	17' x 4'	32,082.00
EML4872G	135"	56"	80 <sup>1</sup> / <sub>4</sub> "	1,505	36"	1,958"	12' x 5'	20,755.00
EML4873G	167"	56"	80 <sup>1</sup> / <sub>4</sub> "	1,955	36"	2,611"	14' x 5'	26,905.00
EML4874G	199"	56"	80 <sup>1</sup> / <sub>4</sub> "	2,405	36"	3,263"	17' x 5'	32,257.00
EML7272G	135"	80"	80 <sup>1</sup> / <sub>4</sub> "	2,153	36"	2,912"	12' x 7'	31,391.00
EML7273G	167"	80"	80 <sup>1</sup> / <sub>4</sub> "	2,770	36"	3,884"	14' x 7'	39,816.00
EML7274G	199"	80"	80 <sup>1</sup> / <sub>4</sub> "	3,431	36"	4,854"	17' x 7'	46,535.00

## Heavy-Duty - 18" Depth

Depth Shelving Model Numbers	System Width	Overall Range Length	Overall Height	Wt.	Aisle	LFI	System Size	List Price
EML3652X	160"	44"	89"	1,297	42"	1,039"	14' x 4'	24,420.00
EML3653X	198"	44"	89"	1,695	42"	1,385"	17' x 4'	31,576.00
EML3654X	236"	44"	89"	2,097	42"	1,731"	20' x 4'	38,681.00
EML4852X	160"	56"	89"	1,465	42"	1,399"	14' x 5'	24,784.00
EML4853X	198"	56"	89"	1,905	42"	1,865"	17' x 5'	31,370.00
EML4854X	236"	56"	89"	2,365	42"	2,331"	20' x 5'	39,227.00

**System Width:** Total length from left to right of system

**Overall Range Length:** From wall to the tip of the handle (dimension includes 1<sup>1</sup>/<sub>2</sub>" clearance from wall)

**Overall Height:** Distance from the floor to the top of shelving

**Aisle:** Walkway between ranges

**LFI:** The amount of Linear Filing Inches offered in each typical

**System Size:** Footprint of the system

### Legal

EML7273G

EML: Mobile Lite

72: Overall shelving length in inches

7: Number of shelves per unit

3: Number of double face movable units

G: Legal media

### Heavy-Duty

EML3652X

EML: Mobile Lite

36: Overall shelving length in inches

5: Number of shelves per unit

2: Number of double face movable units

X: Heavy-duty media

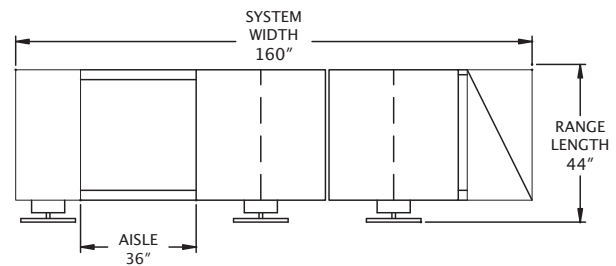
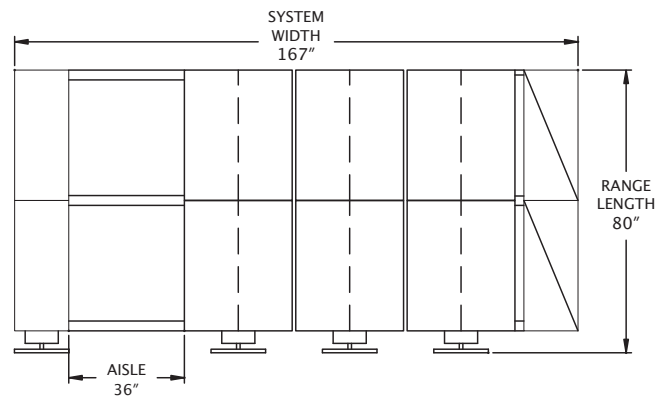

Top View of System Ranges

- 4-Post Shelving starter unit includes two uprights, the required number of shelves (24", 30", 36", 42" or 48" wide), center stops or back stops, shelf supports, shelf reinforcements as required, and one canopy top. Shelves are 18- or 22-gauge steel
- Adder units include the previously mentioned parts with one upright, closed or open
- 240 lb. capacity per shelf. All shelving adjusts on 1½" increments along 4-Post uprights
- Choose from either closed "L" uprights, closed "T" uprights, or open "T" uprights
- "T" uprights are normally for internal range support, while closed "L" uprights provide a more finished external appearance
- Dividers are not included, but are required when using standard common stops (order separately), dividers adjust on 3" increments
- Back panels are optional
- Units sold open-back as standard
- Clearance end tab filing 9¾"
- Standard Safco® Corporate colors, see page 10

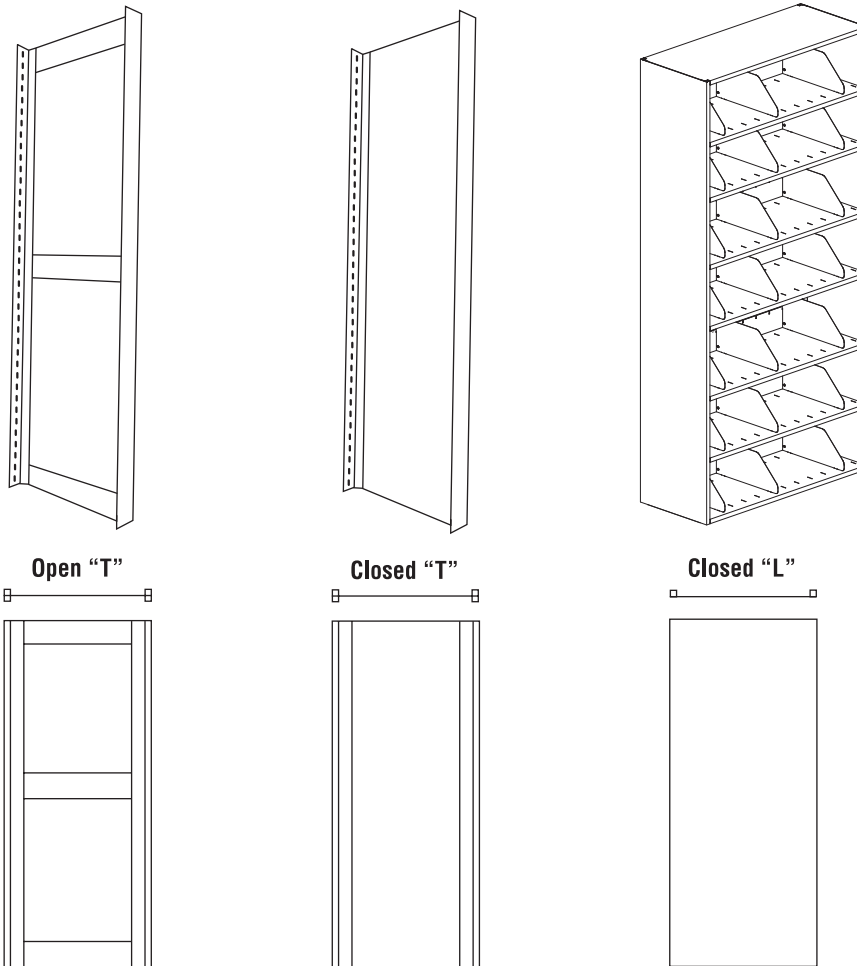

## PRODUCT NUMBERING SCHEME FOR 4-POST SHELVING

Product Number Example: **EFL3624868S**

- E:** Even Dimension 4-Post
- F:** 4-Post Shelving
- L, T or O:** Shelving Type ("L" for Closed L-Upright, "T" for Closed T-Upright, and "O" for Open T-Upright.)
- 36:** Shelving Width in Inches (24, 30, 36, 42 or 48)
- 24:** Shelving Depth in Inches (9, 12, 15, 18, 24, or 30)
- 86:** Upright Height in Inches (43, 65, 76, 86, or 97)
- 8:** Number of Usable Shelves
- S:** Starter
- A:** Adder

# 4-Post Shelving

Safco® Products marketing materials are designed to be used as sales tools for our Dealer network.

## 43" Height, Three-Tier Complete Assemblies (Binder Storage)

- 12" and 15" are single entry only
- 18", 24" and 30" deep are double entry
- Option of ordering with and without Dividers, add "DV" suffix if ordering with dividers (3 dividers per shelf)
- Dividers required for use with common stops
- Standard Safco® Corporate colors, see page 10

### Starter Units with Two Closed "L" Uprights

Model No.	W	D	H	Wt.	Without Dividers		With Dividers	
					List Price	Wt.	Add "DV" Suffix List Price	
EFL2412433S	24"	12"	43"	48	657.00	57	791.00	
EFL2415433S	24"	15"	43"	55	691.00	64	846.00	
EFL2418433S	24"	18"	43"	66	861.00	75	1,257.00	
EFL2424433S	24"	24"	43"	80	905.00	89	1,169.00	
EFL2430433S	24"	30"	43"	99	1,010.00	108	1,311.00	
EFL3012433S	30"	12"	43"	53	657.00	62	791.00	
EFL3015433S	30"	15"	43"	62	691.00	71	846.00	
EFL3018433S	30"	18"	43"	73	869.00	82	1,268.00	
EFL3024433S	30"	24"	43"	89	908.00	98	1,175.00	
EFL3030433S	30"	30"	43"	109	1,012.00	118	1,315.00	
EFL3612433S	36"	12"	43"	59	662.00	68	796.00	
EFL3615433S	36"	15"	43"	68	685.00	77	835.00	
EFL3618433S	36"	18"	43"	81	881.00	90	1,279.00	
EFL3624433S	36"	24"	43"	99	929.00	108	1,192.00	
EFL3630433S	36"	30"	43"	120	1,012.00	129	1,315.00	
EFL4212433S	42"	12"	43"	72	696.00	81	830.00	
EFL4215433S	42"	15"	43"	83	765.00	92	916.00	
EFL4218433S	42"	18"	43"	94	908.00	103	1,307.00	
EFL4224433S	42"	24"	43"	113	985.00	122	1,249.00	
EFL4230433S	42"	30"	43"	136	1,101.00	145	1,375.00	
EFL4812433S	48"	12"	43"	81	772.00	90	905.00	
EFL4815433S	48"	15"	43"	91	849.00	100	1,003.00	
EFL4818433S	48"	18"	43"	104	992.00	113	1,387.00	
EFL4824433S	48"	24"	43"	123	1,062.00	132	1,350.00	
EFL4830433S	48"	30"	43"	148	1,166.00	157	1,462.00	

**NOTE:** Recommend using laminate tops for more finished appearance. Special pricing provided by Space Planning contact your local Safco Sales Rep group.

**NOTE:** 9"D shelving for stand-alone requirements only available by contacting your local Safco Sales Rep Group.

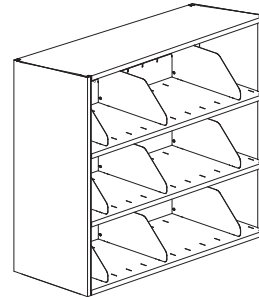

### Adder Units with Open "T" Upright

Model No.	W	D	H	Wt.	Without Dividers		With Dividers	
					List Price	Wt.	Add "DV" Suffix List Price	
EFO2412433A	24"	12"	43"	35	508.00	44	640.00	
EFO2415433A	24"	15"	43"	37	531.00	46	686.00	
EFO2418433A	24"	18"	43"	42	715.00	51	1,113.00	
EFO2424433A	24"	24"	43"	49	744.00	58	1,009.00	
EFO2430433A	24"	30"	43"	59	802.00	68	1,101.00	
EFO3012433A	30"	12"	43"	40	508.00	49	640.00	
EFO3015433A	30"	15"	43"	44	531.00	53	686.00	
EFO3018433A	30"	18"	43"	49	723.00	58	1,122.00	
EFO3024433A	30"	24"	43"	57	746.00	66	1,011.00	
EFO3030433A	30"	30"	43"	68	805.00	77	1,105.00	
EFO3612433A	36"	12"	43"	46	511.00	55	645.00	
EFO3615433A	36"	15"	43"	50	538.00	59	691.00	
EFO3618433A	36"	18"	43"	57	709.00	66	1,122.00	
EFO3624433A	36"	24"	43"	66	746.00	75	1,011.00	
EFO3630433A	36"	30"	43"	79	805.00	88	1,105.00	
EFO4212433A	42"	12"	43"	59	548.00	68	679.00	
EFO4215433A	42"	15"	43"	64	607.00	73	756.00	
EFO4218433A	42"	18"	43"	71	765.00	80	1,162.00	
EFO4224433A	42"	24"	43"	81	822.00	90	1,086.00	
EFO4230433A	42"	30"	43"	95	892.00	104	1,172.00	
EFO4812433A	48"	12"	43"	68	638.00	77	771.00	
EFO4815433A	48"	15"	43"	73	689.00	82	843.00	
EFO4818433A	48"	18"	43"	80	845.00	89	1,243.00	
EFO4824433A	48"	24"	43"	91	923.00	100	1,188.00	
EFO4830433A	48"	30"	43"	108	982.00	117	1,281.00	

### With Closed "T" Upright

Model No.	Wt.	Without Dividers		With Dividers	
		List Price	Wt.	Add "DV" Suffix List Price	
EFT2412433A	37	608.00	46	740.00	
EFT2415433A	42	640.00	51	794.00	
EFT2418433A	50	825.00	59	1,223.00	
EFT2424433A	60	868.00	69	1,132.00	
EFT2430433A	74	963.00	83	1,264.00	
EFT3012433A	42	608.00	51	740.00	
EFT3015433A	49	640.00	58	794.00	
EFT3018433A	57	835.00	66	1,230.00	
EFT3024433A	69	870.00	78	1,137.00	
EFT3030433A	84	966.00	93	1,269.00	
EFT3612433A	48	612.00	57	745.00	
EFT3615433A	55	633.00	64	802.00	
EFT3618433A	64	835.00	73	1,230.00	
EFT3624433A	77	870.00	86	1,137.00	
EFT3630433A	95	966.00	104	1,269.00	
EFT4212433A	62	645.00	71	780.00	
EFT4215433A	69	713.00	78	868.00	
EFT4218433A	78	875.00	87	1,274.00	
EFT4224433A	92	944.00	101	1,208.00	
EFT4230433A	111	1,058.00	120	1,357.00	
EFT4812433A	70	735.00	79	869.00	
EFT4815433A	78	798.00	87	951.00	
EFT4818433A	88	953.00	97	1,354.00	
EFT4824433A	103	1,023.00	112	1,310.00	
EFT4830433A	123	1,145.00	132	1,445.00	

## 65" Height, Six-Tier Complete Assemblies

- 9", 12" and 15" are single entry only
- 18", 24" and 30" deep are double entry
- Option of ordering with and without Dividers, add "DV" suffix if ordering with dividers (3 dividers per shelf)
- Dividers required for use with common stops
- Standard Safco® Corporate colors, see page 10

Starter Units with Two Closed "L" Uprights					Without Dividers		With Dividers Add "DV" Suffix	
Model No.	W	D	H	Wt.	List Price	Wt.	List Price	
EFL2409656S	24"	9"	65"	67	1,009.00	85	1,284.00	
EFL2412656S	24"	12"	65"	79	940.00	97	1,136.00	
EFL2415656S	24"	15"	65"	91	1,009.00	109	1,240.00	
EFL2418656S	24"	18"	65"	109	1,342.00	127	1,941.00	
EFL2424656S	24"	24"	65"	133	1,375.00	151	1,800.00	
EFL2430656S	24"	30"	65"	165	1,596.00	183	2,051.00	
EFL3009656S	30"	9"	65"	75	1,017.00	93	1,321.00	
EFL3012656S	30"	12"	65"	88	940.00	106	1,159.00	
EFL3015656S	30"	15"	65"	103	989.00	121	1,240.00	
EFL3018656S	30"	18"	65"	120	1,350.00	138	1,950.00	
EFL3024656S	30"	24"	65"	148	1,405.00	166	1,806.00	
EFL3030656S	30"	30"	65"	182	1,598.00	200	2,053.00	
EFL3609656S	36"	9"	65"	87	1,017.00	105	1,321.00	
EFL3612656S	36"	12"	65"	91	944.00	109	1,163.00	
EFL3615656S	36"	15"	65"	114	994.00	132	1,247.00	
EFL3618656S	36"	18"	65"	134	1,323.00	152	1,951.00	
EFL3624656S	36"	24"	65"	163	1,377.00	181	1,806.00	
EFL3630656S	36"	30"	65"	201	1,567.00	219	2,012.00	
EFL4209656S	42"	9"	65"	110	1,080.00	128	1,381.00	
EFL4212656S	42"	12"	65"	125	1,028.00	143	1,203.00	
EFL4215656S	42"	15"	65"	142	1,160.00	160	1,364.00	
EFL4218656S	42"	18"	65"	159	1,426.00	177	2,027.00	
EFL4224656S	42"	24"	65"	192	1,566.00	210	1,963.00	
EFL4230656S	42"	30"	65"	232	1,769.00	250	2,178.00	
EFL4809656S	48"	9"	65"	124	1,207.00	142	1,511.00	
EFL4812656S	48"	12"	65"	140	1,204.00	158	1,374.00	
EFL4815656S	48"	15"	65"	157	1,302.00	175	1,532.00	
EFL4818656S	48"	18"	65"	178	1,574.00	196	2,172.00	
EFL4824656S	48"	24"	65"	211	1,701.00	229	2,136.00	
EFL4830656S	48"	30"	65"	254	1,910.00	272	2,366.00	

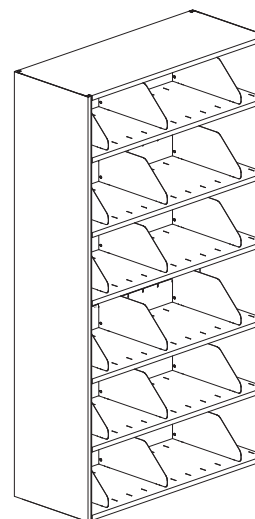

NOTE: 9"D shelving for stand-alone requirements only available by contacting your local Safco Sales Rep Group.

Adder Units with Open "T" Upright					Without Dividers		With Dividers Add "DV" Suffix	
Model No.	W	D	H	Wt.	List Price	Wt.	List Price	
EFO2409656A	24"	9"	65"	55	859.00	73	1,160.00	
EFO2412656A	24"	12"	65"	60	807.00	78	1,009.00	
EFO2415656A	24"	15"	65"	64	847.00	82	1,058.00	
EFO2418656A	24"	18"	65"	74	1,126.00	92	1,725.00	
EFO2424656A	24"	24"	65"	86	1,209.00	104	1,609.00	
EFO2430656A	24"	30"	65"	105	1,328.00	123	1,785.00	
EFO3009656A	30"	9"	65"	64	868.00	82	1,166.00	
EFO3012656A	30"	12"	65"	69	807.00	87	1,009.00	
EFO3015656A	30"	15"	65"	76	847.00	94	1,080.00	
EFO3018656A	30"	18"	65"	86	1,166.00	104	1,734.00	
EFO3024656A	30"	24"	65"	101	1,189.00	119	1,612.00	
EFO3030656A	30"	30"	65"	122	1,332.00	140	1,789.00	
EFO3609656A	36"	9"	65"	75	868.00	93	1,166.00	
EFO3612656A	36"	12"	65"	80	814.00	98	1,012.00	
EFO3615656A	36"	15"	65"	87	837.00	105	1,085.00	
EFO3618656A	36"	18"	65"	99	1,166.00	117	1,770.00	
EFO3624656A	36"	24"	65"	116	1,189.00	134	1,612.00	
EFO3630656A	36"	30"	65"	141	1,332.00	159	1,753.00	
EFO4209656A	42"	9"	65"	99	928.00	117	1,227.00	
EFO4212656A	42"	12"	65"	101	879.00	119	1,080.00	
EFO4215656A	42"	15"	65"	115	999.00	133	1,203.00	
EFO4218656A	42"	18"	65"	126	1,246.00	144	1,810.00	
EFO4224656A	42"	24"	65"	145	1,373.00	163	1,772.00	
EFO4230656A	42"	30"	65"	172	1,502.00	190	1,955.00	
EFO4809656A	48"	9"	65"	113	1,057.00	131	1,357.00	
EFO4812656A	48"	12"	65"	121	1,031.00	139	1,227.00	
EFO4815656A	48"	15"	65"	130	1,142.00	148	1,372.00	
EFO4818656A	48"	18"	65"	144	1,394.00	162	1,993.00	
EFO4824656A	48"	24"	65"	164	1,510.00	182	1,942.00	
EFO4830656A	48"	30"	65"	186	1,643.00	204	2,099.00	

With Closed "T" Upright		Without Dividers		With Dividers Add "DV" Suffix	
Model No.	Wt.	List Price	Wt.	List Price	
EFT2409656A	54	932.00	72	1,255.00	
EFT2412656A	63	905.00	81	1,105.00	
EFT2415656A	71	954.00	89	1,189.00	
EFT2418656A	81	1,230.00	99	1,832.00	
EFT2424656A	102	1,351.00	120	1,748.00	
EFT2430656A	127	1,519.00	145	1,974.00	
EFT3009656A	63	962.00	81	1,264.00	
EFT3012656A	72	905.00	90	1,105.00	
EFT3015656A	83	954.00	101	1,189.00	
EFT3018656A	95	1,303.00	113	1,902.00	
EFT3024656A	117	1,354.00	135	1,752.00	
EFT3030656A	144	1,522.00	162	1,977.00	
EFT3609656A	74	962.00	92	1,264.00	
EFT3612656A	83	911.00	101	1,111.00	
EFT3615656A	94	963.00	112	1,172.00	
EFT3618656A	108	1,303.00	126	1,902.00	
EFT3624656A	132	1,354.00	150	1,753.00	
EFT3630656A	155	1,429.00	173	1,886.00	
EFT4209656A	98	1,020.00	116	1,323.00	
EFT4212656A	109	979.00	127	1,154.00	
EFT4215656A	122	1,106.00	140	1,311.00	
EFT4218656A	135	1,379.00	153	1,978.00	
EFT4224656A	161	1,515.00	179	1,910.00	
EFT4230656A	194	1,693.00	212	2,106.00	
EFT4809656A	112	1,149.00	130	1,454.00	
EFT4812656A	124	1,149.00	142	1,351.00	
EFT4815656A	137	1,247.00	155	1,476.00	
EFT4818656A	153	1,525.00	171	2,129.00	
EFT4824656A	186	1,796.00	204	2,195.00	
EFT4830656A	216	1,834.00	234	2,291.00	



# 4-Post Shelving

Safco® Products marketing materials are designed to be used as sales tools for our Dealer network.

## 76" Height, Seven-Tier Complete Assemblies

- 9", 12" and 15" are single entry only
- 18", 24" and 30" deep are double entry
- Option of ordering with and without Dividers, add "DV" suffix if ordering with dividers (3 dividers per shelf)
- Dividers required for use with common stops
- Standard Safco® Corporate colors, see page 10

### Starter Units with Two Closed "L" Uprights

Model No.	W	D	H	Wt.	Without Dividers		With Dividers	
					List Price	Wt.	Add "DV" Suffix List Price	
EFL2409767S	24"	9"	76"	77	1,188.00	98	1,583.00	
EFL2412767S	24"	12"	76"	92	1,092.00	113	1,379.00	
EFL2415767S	24"	15"	76"	104	1,146.00	125	1,446.00	
EFL2418767S	24"	18"	76"	112	1,524.00	133	2,225.00	
EFL2424767S	24"	24"	76"	153	1,641.00	174	2,106.00	
EFL2430767S	24"	30"	76"	191	1,868.00	212	2,400.00	
EFL3009767S	30"	9"	76"	86	1,188.00	107	1,583.00	
EFL3012767S	30"	12"	76"	102	1,114.00	123	1,379.00	
EFL3015767S	30"	15"	76"	118	1,123.00	139	1,418.00	
EFL3018767S	30"	18"	76"	126	1,516.00	147	2,216.00	
EFL3024767S	30"	24"	76"	171	1,643.00	192	2,108.00	
EFL3030767S	30"	30"	76"	210	1,872.00	231	2,402.00	
EFL3609767S	36"	9"	76"	100	1,175.00	121	1,574.00	
EFL3612767S	36"	12"	76"	115	1,096.00	136	1,385.00	
EFL3615767S	36"	15"	76"	131	1,143.00	152	1,469.00	
EFL3618767S	36"	18"	76"	141	1,516.00	162	2,172.00	
EFL3624767S	36"	24"	76"	188	1,611.00	209	2,108.00	
EFL3630767S	36"	30"	76"	232	1,873.00	253	2,402.00	
EFL4209767S	42"	9"	76"	127	1,224.00	148	1,623.00	
EFL4212767S	42"	12"	76"	145	1,176.00	166	1,465.00	
EFL4215767S	42"	15"	76"	163	1,317.00	184	1,618.00	
EFL4218767S	42"	18"	76"	172	1,591.00	193	2,326.00	
EFL4224767S	42"	24"	76"	222	1,806.00	243	2,269.00	
EFL4230767S	42"	30"	76"	267	2,025.00	288	2,595.00	
EFL4809767S	48"	9"	76"	143	1,369.00	164	1,769.00	
EFL4812767S	48"	12"	76"	163	1,350.00	184	1,642.00	
EFL4815767S	48"	15"	76"	181	1,450.00	202	1,783.00	
EFL4818767S	48"	18"	76"	192	1,773.00	213	2,474.00	
EFL4824767S	48"	24"	76"	251	2,140.00	272	2,605.00	
EFL4830767S	48"	30"	76"	293	2,230.00	314	2,763.00	

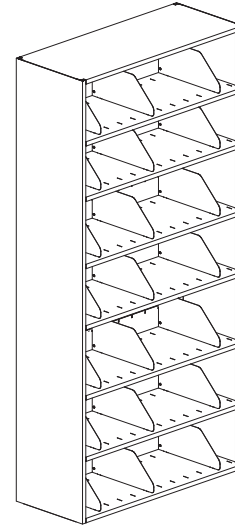

NOTE: 9" D shelving for stand-alone requirements only available by contacting your local Safco Sales Rep Group.

### Adder Units with Open "T" Upright

Model No.	W	D	H	Wt.	Without Dividers		With Dividers	
					List Price	Wt.	Add "DV" Suffix List Price	
EFO2409767A	24"	9"	76"	63	1,001.00	84	1,400.00	
EFO2412767A	24"	12"	76"	69	924.00	90	1,189.00	
EFO2415767A	24"	15"	76"	73	994.00	94	1,295.00	
EFO2418767A	24"	18"	76"	86	1,326.00	107	2,027.00	
EFO2424767A	24"	24"	76"	98	1,386.00	119	1,852.00	
EFO2430767A	24"	30"	76"	121	1,524.00	142	2,055.00	
EFO3009767A	30"	9"	76"	73	1,011.00	94	1,409.00	
EFO3012767A	30"	12"	76"	79	906.00	100	1,189.00	
EFO3015767A	30"	15"	76"	87	994.00	108	1,269.00	
EFO3018767A	30"	18"	76"	99	1,317.00	120	2,017.00	
EFO3024767A	30"	24"	76"	116	1,388.00	137	1,854.00	
EFO3030767A	30"	30"	76"	140	1,528.00	161	2,058.00	
EFO3609767A	36"	9"	76"	86	1,011.00	107	1,409.00	
EFO3612767A	36"	12"	76"	92	929.00	113	1,192.00	
EFO3615767A	36"	15"	76"	100	1,000.00	121	1,302.00	
EFO3618767A	36"	18"	76"	115	1,317.00	136	2,017.00	
EFO3624767A	36"	24"	76"	133	1,360.00	154	1,817.00	
EFO3630767A	36"	30"	76"	162	1,528.00	183	2,059.00	
EFO4209767A	42"	9"	76"	114	1,061.00	135	1,459.00	
EFO4212767A	42"	12"	76"	122	1,026.00	143	1,290.00	
EFO4215767A	42"	15"	76"	132	1,148.00	153	1,422.00	
EFO4218767A	42"	18"	76"	146	1,426.00	167	2,129.00	
EFO4224767A	42"	24"	76"	167	1,553.00	188	1,978.00	
EFO4230767A	42"	30"	76"	197	1,723.00	218	2,208.00	
EFO4809767A	48"	9"	76"	130	1,208.00	151	1,606.00	
EFO4812767A	48"	12"	76"	140	1,206.00	161	1,469.00	
EFO4815767A	48"	15"	76"	150	1,311.00	171	1,612.00	
EFO4818767A	48"	18"	76"	166	1,545.00	187	2,275.00	
EFO4824767A	48"	24"	76"	196	1,887.00	217	2,304.00	
EFO4830767A	48"	30"	76"	223	1,888.00	244	2,370.00	

### With Closed "T" Upright

Model No.	Wt.	Without Dividers		With Dividers	
		List Price	Wt.	Add "DV" Suffix List Price	
EFT2409767A	77	1,357.00	98	1,756.00	
EFT2412767A	73	1,027.00	94	1,294.00	
EFT2415767A	81	1,100.00	102	1,402.00	
EFT2418767A	101	1,499.00	122	2,196.00	
EFT2424767A	117	1,560.00	138	2,024.00	
EFT2430767A	147	1,739.00	168	2,269.00	
EFT3009767A	72	1,111.00	93	1,511.00	
EFT3012767A	83	1,027.00	104	1,268.00	
EFT3015767A	95	1,078.00	116	1,374.00	
EFT3018767A	115	1,485.00	136	2,144.00	
EFT3024767A	135	1,563.00	156	2,026.00	
EFT3030767A	166	1,742.00	187	2,271.00	
EFT3609767A	86	1,111.00	107	1,511.00	
EFT3612767A	96	1,031.00	117	1,297.00	
EFT3615767A	108	1,084.00	129	1,406.00	
EFT3618767A	130	1,455.00	151	2,144.00	
EFT3624767A	152	1,563.00	173	1,986.00	
EFT3630767A	188	1,742.00	209	2,226.00	
EFT4209767A	113	1,162.00	134	1,562.00	
EFT4212767A	126	1,108.00	147	1,367.00	
EFT4215767A	140	1,255.00	161	1,557.00	
EFT4218767A	161	1,596.00	182	2,297.00	
EFT4224767A	186	1,724.00	207	2,189.00	
EFT4230767A	223	1,937.00	244	2,467.00	
EFT4809767A	129	1,310.00	150	1,711.00	
EFT4812767A	144	1,283.00	165	1,545.00	
EFT4815767A	158	1,419.00	179	1,719.00	
EFT4818767A	181	1,744.00	202	2,446.00	
EFT4824767A	215	2,053.00	236	2,521.00	
EFT4830767A	249	2,100.00	270	2,633.00	

86" Height, Eight-Tier Complete Assemblies

- 9", 12" and 15" are single entry only
- 18", 24" and 30" deep are double entry
- Option of ordering with and without Dividers, add "DV" suffix if ordering with dividers (3 dividers per shelf)
- Dividers required for use with common stops
- Standard Safco® Corporate colors, see page 10

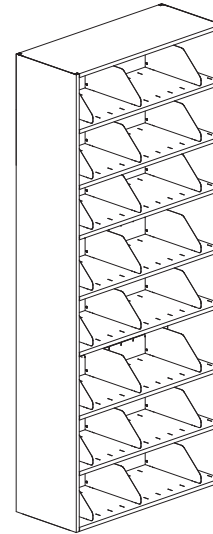

Starter Units with Two Closed "L" Uprights

Model No.	W	D	H	Wt.	Without Dividers		With Dividers Add "DV" Suffix	
					List Price	Wt.	List Price	Wt.
EFL2409868S	24"	9"	86"	87	1,296.00	111	1,695.00	
EFL2412868S	24"	12"	86"	103	1,209.00	127	1,445.00	
EFL2415868S	24"	15"	86"	118	1,275.00	142	1,599.00	
EFL2418868S	24"	18"	86"	121	1,769.00	145	2,565.00	
EFL2424868S	24"	24"	86"	172	1,848.00	196	2,379.00	
EFL2430868S	24"	30"	86"	216	2,070.00	240	2,672.00	
EFL3009868S	30"	9"	86"	98	1,310.00	122	1,677.00	
EFL3012868S	30"	12"	86"	114	1,209.00	138	1,474.00	
EFL3015868S	30"	15"	86"	133	1,301.00	157	1,599.00	
EFL3018868S	30"	18"	86"	136	1,777.00	160	2,574.00	
EFL3024868S	30"	24"	86"	192	1,815.00	216	2,382.00	
EFL3030868S	30"	30"	86"	238	2,075.00	262	2,676.00	
EFL3609868S	36"	9"	86"	113	1,310.00	137	1,677.00	
EFL3612868S	36"	12"	86"	129	1,231.00	153	1,500.00	
EFL3615868S	36"	15"	86"	148	1,280.00	172	1,606.00	
EFL3618868S	36"	18"	86"	154	1,742.00	178	2,574.00	
EFL3624868S	36"	24"	86"	211	1,815.00	235	2,382.00	
EFL3630868S	36"	30"	86"	262	2,075.00	286	2,622.00	
EFL4209868S	42"	9"	86"	144	1,367.00	168	1,763.00	
EFL4212868S	42"	12"	86"	163	1,323.00	187	1,586.00	
EFL4215868S	42"	15"	86"	184	1,444.00	208	1,775.00	
EFL4218868S	42"	18"	86"	189	1,881.00	213	2,679.00	
EFL4224868S	42"	24"	86"	249	2,036.00	273	2,567.00	
EFL4230868S	42"	30"	86"	302	2,294.00	326	2,895.00	
EFL4809868S	48"	9"	86"	162	1,534.00	186	1,935.00	
EFL4812868S	48"	12"	86"	183	1,500.00	207	1,794.00	
EFL4815868S	48"	15"	86"	204	1,651.00	228	1,953.00	
EFL4818868S	48"	18"	86"	212	2,050.00	236	2,846.00	
EFL4824868S	48"	24"	86"	282	2,413.00	306	2,945.00	
EFL4830868S	48"	30"	86"	332	2,479.00	356	3,022.00	

NOTE: 9"D shelving for stand-alone requirements only available by contacting your local Safco Sales Rep Group.

Adder Units with Open "T" Upright

Model No.	W	D	H	Wt.	Without Dividers		With Dividers Add "DV" Suffix	
					List Price	Wt.	List Price	Wt.
EFO2409868A	24"	9"	86"	71	1,111.00	95	1,511.00	
EFO2412868A	24"	12"	86"	77	1,042.00	101	1,307.00	
EFO2415868A	24"	15"	86"	83	1,100.00	107	1,402.00	
EFO2418868A	24"	18"	86"	95	1,485.00	119	2,282.00	
EFO2424868A	24"	24"	86"	111	1,550.00	135	2,083.00	
EFO2430868A	24"	30"	86"	136	1,687.00	160	2,291.00	
EFO3009868A	30"	9"	86"	81	1,123.00	105	1,490.00	
EFO3012868A	30"	12"	86"	88	1,042.00	112	1,308.00	
EFO3015868A	30"	15"	86"	98	1,100.00	122	1,402.00	
EFO3018868A	30"	18"	86"	111	1,492.00	135	2,291.00	
EFO3024868A	30"	24"	86"	108	1,553.00	132	2,085.00	
EFO3030868A	30"	30"	86"	158	1,690.00	182	2,294.00	
EFO3609868A	36"	9"	86"	96	1,123.00	120	1,520.00	
EFO3612868A	36"	12"	86"	103	1,048.00	127	1,313.00	
EFO3615868A	36"	15"	86"	113	1,106.00	137	1,378.00	
EFO3618868A	36"	18"	86"	128	1,492.00	152	2,291.00	
EFO3624868A	36"	24"	86"	150	1,553.00	174	2,044.00	
EFO3630868A	36"	30"	86"	182	1,690.00	206	2,248.00	
EFO4209868A	42"	9"	86"	128	1,179.00	152	1,578.00	
EFO4212868A	42"	12"	86"	137	1,118.00	161	1,403.00	
EFO4215868A	42"	15"	86"	149	1,274.00	173	1,576.00	
EFO4218868A	42"	18"	86"	164	1,597.00	188	2,395.00	
EFO4224868A	42"	24"	86"	188	1,739.00	212	2,267.00	
EFO4230868A	42"	30"	86"	222	1,909.00	246	2,512.00	
EFO4809868A	48"	9"	86"	146	1,346.00	170	1,745.00	
EFO4812868A	48"	12"	86"	157	1,317.00	181	1,609.00	
EFO4815868A	48"	15"	86"	169	1,459.00	193	1,761.00	
EFO4818868A	48"	18"	86"	186	1,766.00	210	2,561.00	
EFO4824868A	48"	24"	86"	221	2,115.00	245	2,594.00	
EFO4830868A	48"	30"	86"	252	2,098.00	276	2,646.00	

With Closed "T" Upright

Model No.	Wt.	Without Dividers		With Dividers Add "DV" Suffix	
		List Price	Wt.	List Price	Wt.
EFT2409868A	71	1,215.00	95	1,613.00	
EFT2412868A	82	1,169.00	106	1,436.00	
EFT2415868A	92	1,228.00	116	1,532.00	
EFT2418868A	110	1,659.00	134	2,459.00	
EFT2424868A	132	1,739.00	156	2,267.00	
EFT2430868A	166	1,934.00	190	2,532.00	
EFT3009868A	82	1,225.00	106	1,625.00	
EFT3012868A	93	1,146.00	117	1,436.00	
EFT3015868A	127	1,503.00	151	1,834.00	
EFT3018868A	152	1,666.00	176	2,463.00	
EFT3024868A	152	1,742.00	176	2,270.00	
EFT3030868A	188	1,937.00	212	2,537.00	
EFT3609868A	97	1,225.00	121	1,625.00	
EFT3612868A	108	1,152.00	132	1,412.00	
EFT3615868A	122	1,215.00	146	1,539.00	
EFT3618868A	143	1,666.00	167	2,463.00	
EFT3624868A	171	1,742.00	195	2,270.00	
EFT3630868A	212	1,937.00	236	2,537.00	
EFT4209868A	128	1,285.00	152	1,683.00	
EFT4212868A	128	1,285.00	152	1,550.00	
EFT4215868A	158	1,376.00	182	1,709.00	
EFT4218868A	178	1,772.00	202	2,568.00	
EFT4224868A	209	1,927.00	233	2,459.00	
EFT4230868A	252	2,155.00	276	2,757.00	
EFT4809868A	146	1,452.00	170	1,849.00	
EFT4812868A	162	1,471.00	186	1,701.00	
EFT4815868A	178	1,592.00	202	1,855.00	
EFT4818868A	201	1,941.00	225	2,738.00	
EFT4824868A	242	2,305.00	266	2,836.00	
EFT4830868A	282	2,344.00	306	2,888.00	

# 4-Post Shelving

Safco® Products marketing materials are designed to be used as sales tools for our Dealer network.

## 97" Height, Nine-Tier Complete Assemblies

- 9", 12" and 15" are single entry only
- 18", 24" and 30" deep are double entry
- Option of ordering with and without Dividers, add "DV" suffix if ordering with dividers (3 dividers per shelf)
- Dividers required for use with common stops
- Standard Safco® Corporate colors, see page 10

### Starter Units with Two Closed "L" Uprights

Model No.	W	D	H	Wt.	Without Dividers		With Dividers	
					List Price	Wt.	Add "DV" Suffix List Price	Wt.
EFL2409979S	24"	9"	97"	91	1,337.00	118	1,837.00	
EFL2412979S	24"	12"	97"	116	1,375.00	143	1,709.00	
EFL2415979S	24"	15"	97"	133	1,437.00	160	1,816.00	
EFL2418979S	24"	18"	97"	142	1,958.00	169	2,856.00	
EFL2424979S	24"	24"	97"	190	2,055.00	217	2,655.00	
EFL2430979S	24"	30"	97"	241	2,171.00	268	2,848.00	
EFL3009979S	30"	9"	97"	111	1,463.00	138	1,961.00	
EFL3012979S	30"	12"	97"	128	1,375.00	155	1,675.00	
EFL3015979S	30"	15"	97"	150	1,437.00	177	1,779.00	
EFL3018979S	30"	18"	97"	159	1,966.00	186	2,864.00	
EFL3024979S	30"	24"	97"	214	2,058.00	241	2,658.00	
EFL3030979S	30"	30"	97"	263	2,275.00	290	2,954.00	
EFL3609979S	36"	9"	97"	126	1,463.00	153	1,922.00	
EFL3612979S	36"	12"	97"	142	1,352.00	169	1,713.00	
EFL3615979S	36"	15"	97"	169	1,446.00	196	1,822.00	
EFL3618979S	36"	18"	97"	178	1,966.00	205	2,864.00	
EFL3624979S	36"	24"	97"	236	2,058.00	263	2,658.00	
EFL3630979S	36"	30"	97"	293	2,275.00	320	2,954.00	
EFL4209979S	42"	9"	97"	161	1,528.00	188	1,987.00	
EFL4212979S	42"	12"	97"	183	1,479.00	210	1,814.00	
EFL4215979S	42"	15"	97"	207	1,600.00	234	1,969.00	
EFL4218979S	42"	18"	97"	218	2,085.00	245	2,981.00	
EFL4224979S	42"	24"	97"	279	2,265.00	306	2,863.00	
EFL4230979S	42"	30"	97"	338	2,470.00	365	3,200.00	
EFL4809979S	48"	9"	97"	181	1,715.00	208	2,215.00	
EFL4812979S	48"	12"	97"	205	1,714.00	232	2,003.00	
EFL4815979S	48"	15"	97"	230	1,839.00	257	2,174.00	
EFL4818979S	48"	18"	97"	243	2,269.00	270	3,169.00	
EFL4824979S	48"	24"	97"	315	2,692.00	342	3,290.00	
EFL4830979S	48"	30"	97"	370	2,680.00	397	3,345.00	

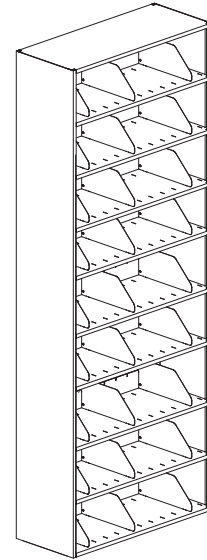

NOTE: 9"D shelving for stand-alone requirements only available by contacting your local Safco Sales Rep Group.

### Adder Units with Open "T" Upright

Model No.	W	D	H	Wt.	Without Dividers		With Dividers	
					List Price	Wt.	Add "DV" Suffix List Price	Wt.
EFO2409979A	24"	9"	97"	80	1,221.00	107	1,719.00	
EFO2412979A	24"	12"	97"	86	1,147.00	113	1,476.00	
EFO2415979A	24"	15"	97"	92	1,208.00	119	1,585.00	
EFO2418979A	24"	18"	97"	107	1,635.00	134	2,531.00	
EFO2424979A	24"	24"	97"	121	1,711.00	148	2,305.00	
EFO2430979A	24"	30"	97"	150	1,858.00	177	2,537.00	
EFO3009979A	30"	9"	97"	92	1,230.00	119	1,731.00	
EFO3012979A	30"	12"	97"	98	1,147.00	125	1,476.00	
EFO3015979A	30"	15"	97"	109	1,184.00	136	1,553.00	
EFO3018979A	30"	18"	97"	124	1,643.00	151	2,542.00	
EFO3024979A	30"	24"	97"	143	1,713.00	170	2,308.00	
EFO3030979A	30"	30"	97"	175	1,861.00	202	2,540.00	
EFO3609979A	36"	9"	97"	109	1,230.00	136	1,731.00	
EFO3612979A	36"	12"	97"	115	1,127.00	142	1,482.00	
EFO3615979A	36"	15"	97"	126	1,191.00	153	1,561.00	
EFO3618979A	36"	18"	97"	143	1,643.00	170	2,542.00	
EFO3624979A	36"	24"	97"	165	1,713.00	192	2,308.00	
EFO3630979A	36"	30"	97"	202	1,861.00	229	2,540.00	
EFO4209979A	42"	9"	97"	144	1,301.00	171	1,797.00	
EFO4212979A	42"	12"	97"	153	1,252.00	180	1,551.00	
EFO4215979A	42"	15"	97"	166	1,372.00	193	1,713.00	
EFO4218979A	42"	18"	97"	183	1,761.00	210	2,659.00	
EFO4224979A	42"	24"	97"	208	1,918.00	235	2,516.00	
EFO4230979A	42"	30"	97"	247	2,064.00	274	2,784.00	
EFO4809979A	48"	9"	97"	164	1,485.00	191	1,985.00	
EFO4812979A	48"	12"	97"	175	1,450.00	202	1,778.00	
EFO4815979A	48"	15"	97"	189	1,610.00	216	1,947.00	
EFO4818979A	48"	18"	97"	208	1,950.00	235	2,846.00	
EFO4824979A	48"	24"	97"	244	2,344.00	271	2,941.00	
EFO4830979A	48"	30"	97"	279	2,320.00	306	2,996.00	

### With Closed "T" Upright

Model No.	Wt.	Without Dividers		With Dividers	
		List Price	Wt.	Add "DV" Suffix List Price	Wt.
EFT2409979A	77	1,345.00	104	1,843.00	
EFT2412979A	92	1,297.00	119	1,631.00	
EFT2415979A	103	1,360.00	130	1,739.00	
EFT2418979A	115	1,834.00	142	2,731.00	
EFT2424979A	147	1,920.00	174	2,519.00	
EFT2430979A	129	2,129.00	156	2,804.00	
EFT3009979A	91	1,359.00	118	1,821.00	
EFT3012979A	104	1,297.00	131	1,598.00	
EFT3015979A	120	1,360.00	147	1,704.00	
EFT3018979A	132	1,839.00	159	2,739.00	
EFT3024979A	169	1,925.00	196	2,521.00	
EFT3030979A	210	2,131.00	237	2,807.00	
EFT3609979A	108	1,359.00	135	1,821.00	
EFT3612979A	121	1,303.00	148	1,635.00	
EFT3615979A	137	1,369.00	164	1,745.00	
EFT3618979A	151	1,839.00	178	2,739.00	
EFT3624979A	191	1,925.00	218	2,521.00	
EFT3630979A	237	2,131.00	264	2,807.00	
EFT4209979A	143	1,422.00	170	1,886.00	
EFT4212979A	159	1,402.00	186	1,732.00	
EFT4215979A	177	1,557.00	204	1,897.00	
EFT4218979A	191	1,958.00	218	2,856.00	
EFT4224979A	234	2,130.00	261	2,725.00	
EFT4230979A	282	2,376.00	309	3,055.00	
EFT4809979A	163	1,610.00	190	2,108.00	
EFT4812979A	181	1,633.00	208	1,922.00	
EFT4815979A	200	1,763.00	227	2,101.00	
EFT4818979A	216	2,147.00	243	3,043.00	
EFT4824979A	270	2,553.00	297	3,153.00	
EFT4830979A	314	2,589.00	341	3,267.00	

• For assistance with custom 4 post configuration contact your local Safco Sales Rep Group.

## Components

### Closed "L" Uprights

Model No.	D	Wt.	List Price	Model No.	D	Wt.	List Price
<b>43" Height</b>				<b>86" Height</b>			
EF1243L	12"	11	137.00	EF0986L	9"	16	158.00
EF1543L	15"	13	139.00	EF1286L	12"	21	162.00
EF1843L	18"	16	150.00	EF1586L	15"	26	172.00
EF2443L	24"	20	158.00	EF1886L	18"	33	224.00
EF3043L	30"	25	185.00	EF2486L	24"	40	232.00
<b>65" Height</b>				<b>97" Height</b>			
EF1265L	12"	16	137.00	EF1297L	12"	24	183.00
EF1565L	15"	20	142.00	EF1597L	15"	30	189.00
EF1865L	18"	24	170.00	EF1897L	18"	35	244.00
EF2465L	24"	31	175.00	EF2497L	24"	45	260.00
EF3065L	30"	38	215.00	EF3097L	30"	56	297.00
<b>76" Height</b>							
EF0976L	9"	14	151.00				
EF1276L	12"	19	154.00				
EF1576L	15"	23	158.00				
EF1876L	18"	29	178.00				
EF2476L	24"	36	208.00				
EF3076L	30"	44	268.00				



### Closed "T" Uprights

Model No.	D	Wt.	List Price	Model No.	D	Wt.	List Price
<b>43" Height</b>				<b>86" Height</b>			
EF1543T	15"	13	230.00	EF1286T	12"	21	268.00
EF1843T	18"	16	266.00	EF1586T	15"	26	273.00
				EF1886T	18"	31	343.00
				EF2486T	24"	40	351.00
<b>65" Height</b>				<b>97" Height</b>			
EF1265T	12"	16	215.00	EF1597T	15"	30	295.00
EF1865T	18"	25	290.00	EF1897T	18"	37	360.00
				EF2497T	24"	45	370.00
				EF3097T	30"	56	449.00
<b>76" Height</b>							
EF1276T	12"	19	235.00				
EF1576T	15"	23	250.00				
EF1876T	18"	31	330.00				
EF2476T	24"	36	333.00				

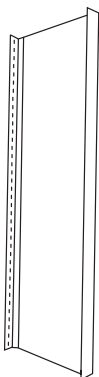

### Open Uprights (OP)

Model No.	D	Wt.	List Price	Model No.	D	Wt.	List Price
<b>43" Height</b>				<b>86" Height</b>			
EF1243OP	12"	8.75	122.00	EF0986OP	9"	16	134.00
EF1543OP	15"	9	122.00	EF1286OP	12"	16.5	138.00
EF1843OP	18"	9.25	158.00	EF1586OP	15"	17	147.00
EF2443OP	24"	9.5	158.00	EF1886OP	18"	17.5	169.00
				EF2486OP	24"	19	169.00
				EF3086OP	30"	20	178.00
<b>65" Height</b>				<b>97" Height</b>			
EF1265OP	12"	13.25	122.00	EF1297OP	12"	16.5	138.00
EF1565OP	15"	13.5	124.00	EF1597OP	15"	17	147.00
EF1865OP	18"	13.75	162.00	EF1897OP	18"	17.5	172.00
EF2465OP	24"	15	162.00	EF2497OP	24"	19	169.00
EF3065OP	30"	16	166.00	EF3097OP	30"	20	178.00
<b>76" Height</b>							
EF1276OP	12"	15.25	138.00				
EF1576OP	15"	15.5	147.00				
EF1876OP	18"	16	161.00				
EF2476OP	24"	17	164.00				
EF3076OP	30"	18	190.00				

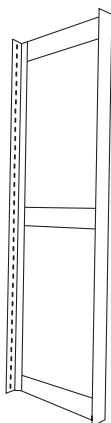

Office Suites  
Seating  
Tables & Desks  
Meeting Essentials  
Personal Organization  
Ergonomics  
High Density Storage  
Storage & Filing  
Facilities  
Technology Furniture  
Art & Engineering  
K-12 Education  
SAFE Collection Addendum

## Components

- Order two supports per shelf
- Shelves are 3/4" - have a 3/4" height profile
- Shelves are slotted to accept dividers on 3" centers/increments
- See page 160 for shelf reinforcements for 18, 24, 30" deep

- Standard Safco® Corporate colors, see page 10
- For assistance with custom 4 post configuration contact your local Safco Sales Rep Group.

### Slotted Shelves (SS) – 22-gauge

Model No.	D	Wt.	List Price
<b>24" Width</b>			
EF2412S	12"	3.25	43.00
EF2415S	15"	3.75	46.00
EF2424S	24"	5.75	74.00
<b>30" Width</b>			
EF3012S	12"	3.75	43.00
EF3015S	15"	4.75	47.00
EF3024S	24"	7.25	76.00
EF3030S	30"	8.75	88.00
<b>36" Width</b>			
EF3609S	9"	3.75	51.00
EF3612S	12"	4.5	43.00
EF3615S	15"	5.5	47.00
EF3618S	18"	6.5	74.00
EF3624S	24"	8.5	76.00
EF3630S	30"	10.5	88.00
<b>42" Width</b>			
EF4212S	12"	5.25	52.00
EF4215S	15"	6.5	63.00
EF4224S	24"	9.75	100.00
EF4230S	30"	12	111.00
<b>48" Width</b>			
EF4809S	9"	4.75	62.00
EF4812S	12"	6	63.00
EF4815S	15"	7.25	75.00
EF4818S	18"	8.5	98.00
EF4824S	24"	11	117.00
EF4830S	30"	13.75	123.00

### Unslotted Shelves, or Canopy Top (UU) – 22-gauge

Model No.	D	Wt.	List Price
<b>24" Width</b>			
EF2412U	12"	3.25	43.00
EF2415U	15"	3.75	46.00
EF2418U	18"	4.5	63.00
EF2424U	24"	5.75	71.00
EF2430U	30"	7	75.00
<b>30" Width</b>			
EF3012U	12"	3.75	43.00
EF3015U	15"	4.75	47.00
EF3018U	18"	5.5	73.00
EF3024U	24"	7.25	75.00
EF3030U	30"	8.75	88.00
<b>36" Width</b>			
EF3609U	9"	3.75	52.00
EF3612U	12"	4.5	47.00
EF3615U	15"	5.5	55.00
EF3618U	18"	6.5	73.00
EF3624U	24"	8.5	75.00
EF3630U	30"	10.5	88.00
<b>42" Width</b>			
EF4209U	9"	4.25	47.00
EF4212U	12"	5.25	52.00
EF4215U	15"	6.5	62.00
EF4218U	18"	7.5	76.00
EF4224U	24"	9.75	90.00
EF4230U	30"	12	105.00
<b>48" Width</b>			
EF4809U	9"	4.75	62.00
EF4812U	12"	6	58.00
EF4815U	15"	7.25	71.00
EF4818U	18"	8.5	91.00
EF4824U	24"	11	98.00
EF4830U	30"	13.75	109.00

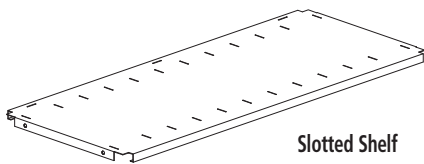

Slotted Shelf

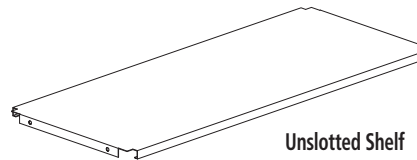

Unslotted Shelf

## Components

- Order two supports per shelf
- Shelves are slotted to accept dividers on 3" centers/increments
- See page 160 for shelf reinforcements for 18, 24, 30" deep

### Slotted Shelves (SS) – 18-gauge

Model No.	D	Wt.	List Price
<b>36" Width</b>			
EF3612S18GA	12"	7.25	95.00
EF3615S18GA	15"	8.75	96.00
EF3618S18GA	18"	10.25	103.00
EF3624S18GA	24"	13.5	185.00
<b>42" Width</b>			
EF4215S18GA	15"	10.25	96.00
<b>48" Width</b>			
EF4812S18GA	12"	9.5	98.00

Note: Order two supports per shelf. Shelves are slotted to accept dividers on 3" centers/increments.

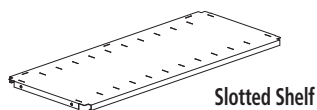

Slotted Shelf

- Standard Safco® Corporate colors, see page 10
- For assistance with custom 4 post configuration contact your local Safco Sales Rep Group.

### Unslotted Shelves, or Canopy Top (UU) – 18-gauge

Model No.	D	Wt.	List Price
<b>30" Width</b>			
EF3012U18GA	12"	6	83.00
EF3018U18GA	18"	8.75	98.00
EF3024U18GA	24"	11.25	196.00
EF3030U18GA	30"	14	199.00
EF3036U18GA	36"	16.5	204.00
<b>36" Width</b>			
EF3612U18GA	12"	7.25	95.00
EF3615U18GA	15"	8.75	98.00
EF3618U18GA	18"	10.25	105.00
EF3624U18GA	24"	13.5	199.00
EF3630U18GA	30"	16.5	204.00
EF3636U18GA	36"	19.5	203.00
<b>42" Width</b>			
EF4215U18GA	15"	10.25	101.00
EF4218U18GA	18"	12	105.00
EF4224U18GA	24"	15.5	203.00
EF4230U18GA	30"	19.25	204.00
EF4236U18GA	36"	22.75	203.00
<b>48" Width</b>			
EF4812U18GA	12"	9.5	105.00
EF4815U18GA	15"	11.5	104.00
EF4818U18GA	18"	13.75	101.00
EF4824U18GA	24"	17.75	205.00
EF4830U18GA	30"	21.75	204.00
EF4836U18GA	36"	26	208.00

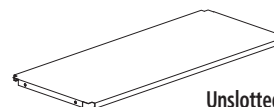

Unslotted Shelf

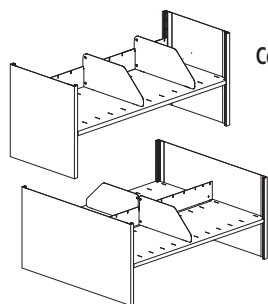

Common Stop Single

Common Stop Double

### Common Stops (CS)

Model No.	W	H	Wt.	List Price
EF24CS	24"	3 1/2"	1.25	14.00
EF30CS	30"	3 1/2"	1.5	14.00
EF36CS	36"	3 1/2"	1.5	14.00
EF42CS	42"	3 1/2"	1.75	15.00
EF48CS	48"	3 1/2"	2	15.00

Note: Dividers are required when using common stops.

# 4-Post Shelving Components

Safco® Products marketing materials are designed to be used as sales tools for our Dealer network.

• For assistance with custom 4 post configuration contact your local Safco Sales Rep Group.

## COMPONENTS

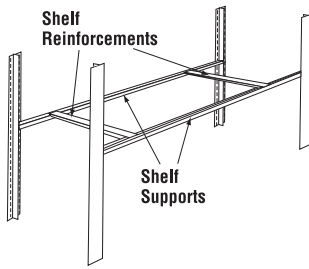

### Shelf Supports (SS) - 11 gauge only

Model No.	W	H	Wt.	List Price
EF2411SSPT	24"	3/4"	1.2	18.00
EF3011SSPT	30"	3/4"	2.25	18.00
EF3611SSPT	36"	3/4"	2.7	18.00
EF4211SSPT	42"	3/4"	3.2	18.00
EF4811SSPT	48"	3/4"	3.6	25.00

Note: Shelf supports are not interchangeable with bottom shelf supports.

### Shelf Support Bottom (SSB)

EF2411SSB	24"	3/4"	3.6	18.00
EF3011SSB	30"	3/4"	2.25	18.00
EF3611SSB	36"	3/4"	2.7	18.00
EF4211SSB	42"	3/4"	3.25	18.00
EF4811SSB	48"	3/4"	3.6	25.00

Note: Bottom shelf must be supported by bottom shelf supports when mounted on a mobile carriage. Graphite paint only.

	24"	30"	36"	42"	48"
18"	1	1	1	1	2
24"	1	1	1	1	2
30"	2	2	2	2	2
36"	2	2	2	3	3

Number of Shelf Reinforcements required per loaded shelf.

### Shelf Reinforcements (SRA) – Indicate color to match system

Model No.	D	H	Wt.	List Price
F15SRA	15"	3/4"	.75	25.00
F18SRA	18"	3/4"	.75	14.00
F24SRA	24"	3/4"	1	17.00
F30SRA	30"	3/4"	1.25	17.00
F36SRA	36"	3/4"	1.25	17.00

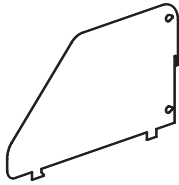

### Adjustable File Dividers (DV)

#### Standard Pack of 6

Model No.	D	H	Wt.	List Price
F09DV6	9"	6"	3	100.00
F12DV6	12"	6"	3.5	67.00
F15DV6	15"	6"	4.5	76.00

#### Standard Pack of 24

Model No.	D	H	Wt.	List Price
F09DV24	9"	6"	12.5	403.00
F12DV24	12"	6"	13.5	271.00
F15DV24	15"	6"	17.5	310.00

### Pullout Reference Shelves (RS)

Model No.	W	D	Wt.	List Price
EF30RS	30"	12"	17.25	400.00
EF36RS	36"	12"	20	432.00
EF42RS	42"	12"	22	453.00
EF48RS	48"	12"	25.75	477.00

Note: Reference shelves cannot be used in conjunction with either the Security Shade or Kick Plates.

### Base Kick Plates (KP)

To be used with standard shelf supports on bottom shelf and slightly raises height of bottom shelf.

Model No.	W	H	Wt.	List Price
EF3002KP	30"	2"	1.25	38.00
EF3006KP	30"	6"	3.25	62.00
EF3602KP	36"	2"	2	39.00
EF3606KP	36"	6"	4	62.00
EF4202KP	42"	2"	2.25	46.00
EF4206KP	42"	6"	4.75	64.00
EF4802KP	48"	2"	2.5	46.00
EF4806KP	48"	6"	5.5	75.00

Note: Kick Plates cannot be used in conjunction with Reference Shelves.

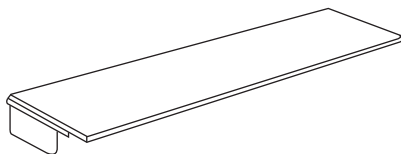



### Back Security Panels (BP) Used to enclose the back of a single faced unit

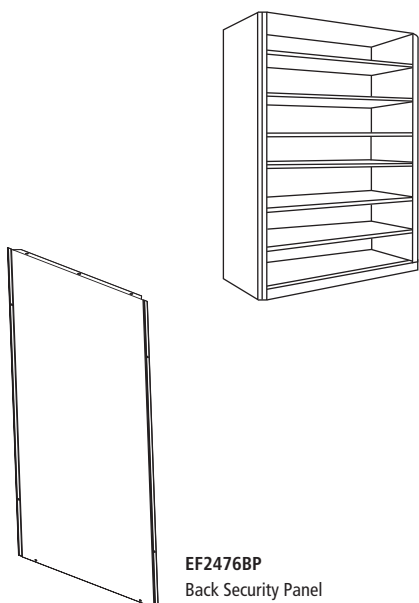

Model No.	W	H	Wt.	List Price
EF3643BP	36"	43"	16.25	376.00
EF4843BP	48"	43"	21.75	389.00
EF2465BP	24"	65"	16.5	405.00
EF3065BP	30"	65"	20.5	408.00
EF3665BP	36"	65"	24.75	416.00
EF4265BP	42"	65"	29	428.00
EF4865BP	48"	65"	33	424.00
EF3076BP	30"	76"	24	428.00
EF3676BP	36"	76"	28.75	428.00
EF4276BP	42"	76"	33.5	435.00
EF4876BP	48"	76"	38.25	467.00
EF3086BP	30"	86"	27.25	443.00
EF3686BP	36"	86"	38.5	443.00
EF4286BP	42"	86"	38	484.00
EF4886BP	48"	86"	43.5	522.00
EF3097BP	30"	97"	30.5	512.00
EF3697BP	36"	97"	36.5	522.00
EF4297BP	42"	97"	42.75	579.00
EF4897BP	48"	97"	48.75	615.00

Note: Back security panels are designed as one full piece.

### Center Panels (CP)

Used to close the center of back-to-back single faced units. Cannot be used with 4-Post double-faced shelving.

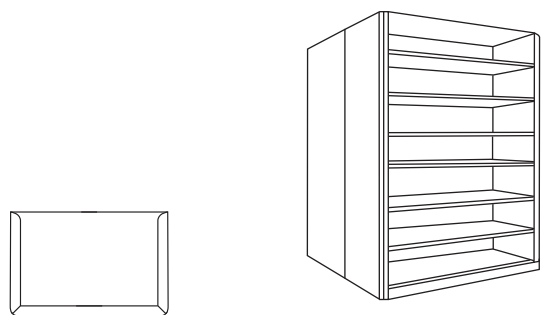

Model No.	W	H	Wt.	List Price
EF2443CP	24"	43"	11	374.00
EF3043CP	30"	43"	13.75	383.00
EF3643CP	36"	43"	16.25	375.00
EF4243CP	42"	43"	19	394.00
EF4843CP	48"	43"	21.75	400.00
EF2465CP	24"	65"	16.5	408.00
EF3065CP	30"	65"	20.5	416.00
EF3665CP	36"	65"	24.75	408.00
EF4265CP	42"	65"	29	428.00
EF4865CP	48"	65"	33	424.00
EF2476CP	24"	76"	19.25	416.00
EF3076CP	30"	76"	24	419.00
EF3676CP	36"	76"	28.75	419.00
EF4276CP	42"	76"	33.5	427.00
EF4876CP	48"	76"	38.5	457.00
EF2486CP	24"	86"	21.25	432.00
EF3086CP	30"	86"	27.25	443.00
EF3686CP	36"	86"	32.5	434.00
EF4286CP	42"	86"	38	474.00
EF4886CP	48"	86"	43.5	506.00
EF2497CP	24"	97"	24.25	468.00
EF3097CP	30"	97"	30.5	522.00
EF3697CP	36"	97"	36.5	512.00
EF4297CP	42"	97"	42.75	579.00
EF4897CP	48"	97"	48.75	615.00

Note: Center panels are designed as one full piece

### Card Holders (CH) – Standard Pack of 5

Model No.	W	D	Wt.	List Price
A35CH5	5"	3"	2.5	211.00

### Wall Mounting Kit (AWMK)

Used to secure shelving to wall. Two brackets sold as pair. Anchoring hardware not included; to be purchased by installer.

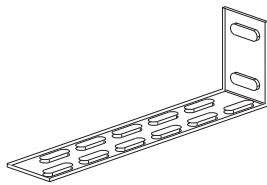

Model No.	Wt.	List Price
AWMK	2	84.00

### AWMK Wall Anchor Kit quantity requirements

Quantity of "L" and "T" Uprights: 2-4 uprights: (1) AWMK Mounting Kit  
5-8 uprights: (2) AWMK Mounting Kit  
9-12 uprights: (3) AWMK Mounting Kit



Office Suites  
Seating  
Tables & Desks  
Meeting Essentials  
Personal Organization  
Ergonomics  
High Density Storage  
Storage & Filing  
Facilities  
Technology Furniture  
Art & Engineering  
K-12 Education  
SAFE Collection Addendum

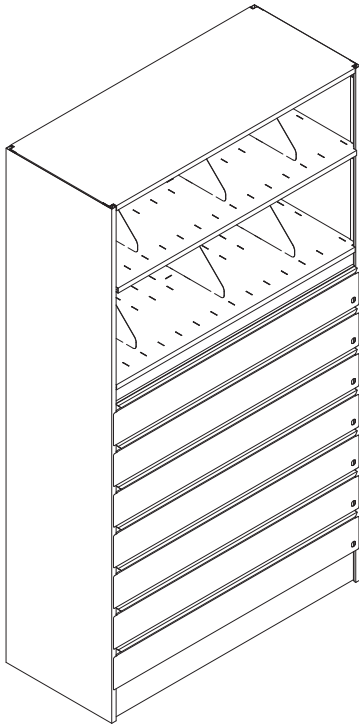

### 4-POST TYPICAL #1

4-Post Starter 36 x 76 x 18" with 7 - 6" drawers with three drawer partitions and one partition support per drawer; two shelves with dividers.

Model No.	List Price
<b>EFSR367676S</b>	<b>9,236.00</b>

4-Post Adder 36 x 76 x 18" with 7 - 6" drawers; two shelves with dividers.

<b>EFSR367676A</b>	<b>9,121.00</b>
--------------------	-----------------

One starter unit and number of required adder units are required if more than one 36" shelving unit is required side-by-side.

For keyed different locks.

<b>FPALOCK</b>	FPA Lock Assembly & Key	128.00
<b>FPALOCKA</b>	FPA Lock Assembly & Key	131.00
<b>FPALOCKB</b>	FPA Lock Assembly & Key	131.00
<b>FPALOCKC</b>	FPA Lock Assembly & Key	131.00
<b>FPALOCKD</b>	FPA Lock Assembly & Key	131.00

\*Unit requires anchoring to the wall or floor  
See wall mounting kit page 163

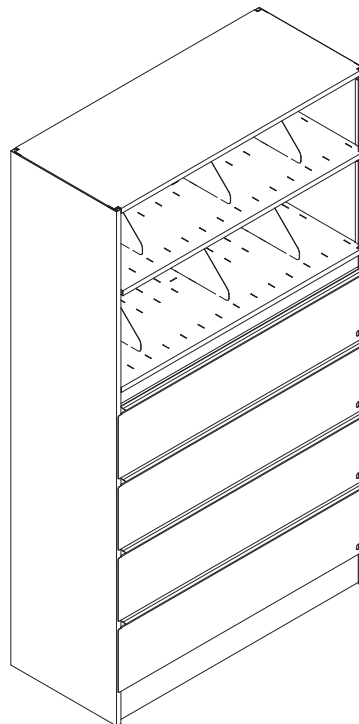

### 4-POST TYPICAL #2

4-Post Starter 36 x 76 x 18" with four 10 1/2" drawers; two shelves with dividers.

Model No.	List Price
<b>EFSR3676410S</b>	<b>5,270.00</b>

4-Post Adder 36 x 76 x 18" with four 10 1/2" drawers; two shelves with dividers.

<b>EFSR3676410A</b>	<b>5,348.00</b>
---------------------	-----------------

One starter unit and number of required adder units are required if more than one 36" shelving unit is required side-by-side.

\* Unit requires anchoring to the wall or floor.  
See wall mounting kit page 163

## Actual Width Dimensions

Stationary or Mobile			Mobile Only			
Nominal Shelf Width	(LFI) Usable Space/Shelf	Add for End Actual Unit Width	Add for End Panel Assembly (Fix & Manual)	Add for Assembly with Handle (1000 Systems)	Clearance at Rear Wall	
24"	22 <sup>5</sup> / <sub>8</sub> "	24"	3 <sup>3</sup> / <sub>4</sub> "	8"	1"	
30"	28 <sup>5</sup> / <sub>8</sub> "	30"	3 <sup>3</sup> / <sub>4</sub> "	8"	1"	
36"	34 <sup>5</sup> / <sub>8</sub> "	36"	3 <sup>3</sup> / <sub>4</sub> "	8"	1"	
42"	40 <sup>5</sup> / <sub>8</sub> "	42"	3 <sup>3</sup> / <sub>4</sub> "	8"	1"	
48"	46 <sup>5</sup> / <sub>8</sub> "	48"	3 <sup>3</sup> / <sub>4</sub> "	8"	1"	

Actual Height Dimensions					Actual Base Dimensions (Base Depth*)			
	43"	65"	76"	86"	97"	Nominal Shelf Depth	Fixed**	1000*
Upright	42 <sup>5</sup> / <sub>16</sub> "	65 <sup>5</sup> / <sub>16</sub> "	75 <sup>13</sup> / <sub>16</sub> "	86 <sup>5</sup> / <sub>16</sub> "	96 <sup>13</sup> / <sub>16</sub> "	9"	N/A	N/A
Base & Track	N/A	6 <sup>1</sup> / <sub>4</sub> "	6 <sup>1</sup> / <sub>4</sub> "	6 <sup>1</sup> / <sub>4</sub> "	6 <sup>1</sup> / <sub>4</sub> "	12"	12"	19"
Overall	N/A	71 <sup>9</sup> / <sub>16</sub> "	82 <sup>1</sup> / <sub>16</sub> "	92 <sup>9</sup> / <sub>16</sub> "	103 <sup>1</sup> / <sub>16</sub> "	15"	15"	19"
						18"	18"	19"
						24"	24"	25"
						30"	30"	31"
						36"	36"	37"

\*Depth includes the 1" bumpers.  
\*\*Depth does not include the 1" bumpers.

### Steel Material Gauges:

Shelf	18 & 22	Shelf Reinforcement	11
Upright	18	Base Skirts	12
End Panel	20	Wheel Channel	11
Dividers	20	Shaft Diameter	3/4"
Shelf Support	11	Wheel Diameter	4 <sup>5</sup> / <sub>8</sub> "



### Media Weight:

Letter-Size Material:	2 lbs. per LFI
Legal-Size Material:	3 lbs. per LFI

NOTE: EACH SHELF HAS A MAXIMUM WEIGHT CAPACITY OF 240 LBS. MEDIA WEIGHT MUST BE EVENLY DISTRIBUTED BOTH VERTICALLY AND HORIZONTALLY.

## CONFIGURATION GUIDE

### Configuration Guide for Mixed Media Applications

Media	Description	Clearance Space	Upright Space Required
	Letter/Legal Side Tab	9 <sup>3</sup> / <sub>4</sub> "	10 <sup>1</sup> / <sub>2</sub> "
	Letter/Legal Standard Top Tab, 1/3 cut	11 <sup>1</sup> / <sub>4</sub> "	12"
	3-Ring Binders	12 <sup>3</sup> / <sub>4</sub> "	13 <sup>1</sup> / <sub>2</sub> "

To determine the height of a unit with media not listed above, first determine the height of the media and add 3/4". Then, round that figure up to the next number divisible by 1 1/2" (because the uprights are slotted on 1 1/2" centers), then multiply that number by the number of tiers desired. Then add 1 1/2" for space that is allotted for the reference shelf. Lastly, add 3/4" for the canopy.

### Media Storage Capacities

Upright Height	Letter/Legal Side Tab	Letter/Std. Top Tab	3-Ring Binders
97" Upright	9	8	7
86" Upright	8	7	6
76" Upright	7	6	5
65" Upright	6	5	4
43" Upright	4	3	3

# 4-Post Shelving On Kwik-Track - Letter Depth

Safco® Products marketing materials are designed to be used as sales tools for our Dealer network.

To increase filing density, 4-Post Shelving can also mount to the Kwik-Track system creating either a bi-file or tri-file lateral sliding shelving system. In either configuration, the rear row of shelves are stationary with shelves in front mounted into a sliding carriage on a track mounted to the floor.

- Heavy-duty aluminum track construction supports 3,500 lbs. per carriage
- Anti-tip built into base for stability and easy installation
- Systems are complete with shelving and track systems
- **Option of ordering with and without Dividers, add "DV" suffix if ordering with dividers**
- 240 lb. weight capacity per shelf
- Track system has a Brushed Aluminum finish. Floor mounting hardware included
- Track adds 2¾" to overall height of shelving and carriage
- Optional Security Back Panels available (See page 161)
- All systems are side tab letter depth, 12"D shelving only, maximum 15 ft.
- For assistance with custom Kwik-Track configuration contact your local Safco Sales Rep Group.
- Standard Safco® Corporate colors, see page 10

Model No.	Description	Dimensions	LFI	Wt.	Without Dividers List Price	With Dividers Add "DV" Suffix List Price
EFPL36721	2/1, 36"W, 7-High System	78"W x 27"D	728"	363	5,429.00	396 6,160.00
EFPL36732	3/2, 36"W, 7-High System	116"W x 27"D	1212"	597	9,097.00	652 10,268.00
EFPL36743	4/3, 36"W, 7-High System	156"W x 27"D	1697"	830	12,316.00	907 14,183.00
EFPL367211	2/1/1, 36"W, 7-High System	78"W x 42"D	970"	518	8,584.00	562 9,300.00
EFPL367322	3/2/2, 36"W, 7-High System	116"W x 42"D	1697"	893	15,169.00	970 16,784.00
EFPL367433	4/3/3, 36"W, 7-High System	156"W x 42"D	2424"	1,268	21,356.00	1,378 23,612.00
EFPL36821	2/1, 36"W, 8-High System	78"W x 27"D	824"	402	5,758.00	440 6,555.00
EFPL36832	3/2, 36"W, 8-High System	116"W x 27"D	1385"	660	9,824.00	723 10,927.00
EFPL36843	4/3, 36"W, 8-High System	156"W x 27"D	1939"	918	13,305.00	1,006 14,808.00
EFPL368211	2/1/1, 36"W, 8-High System	78"W x 42"D	1108"	571	9,016.00	621 9,846.00
EFPL368322	3/2/2, 36"W, 8-High System	116"W x 42"D	1939"	984	15,922.00	1,072 17,726.00
EFPL368433	4/3/3, 36"W, 8-High System	156"W x 42"D	2770"	1,398	22,427.00	1,523 24,506.00
EFPL42721	2/1, 42"W, 7-High System	90"W x 27"D	854"	726	5,671.00	759 6,518.00
EFPL42732	3/2, 42"W, 7-High System	137"W x 27"D	1422"	756	9,521.00	811 10,693.00
EFPL42743	4/3, 42"W, 7-High System	180"W x 27"D	1991"	1,047	13,096.00	1,124 14,676.00
EFPL427211	2/1/1, 42"W, 7-High System	90"W x 42"D	1138"	646	9,131.00	696 9,835.00
EFPL427322	3/2/2, 42"W, 7-High System	137"W x 42"D	1991"	1,071	15,796.00	1,148 17,407.00
EFPL427433	4/3/3, 42"W, 7-High System	180"W x 42"D	2844"	1,585	22,650.00	1,695 24,407.00
EFPL42821	2/1, 42"W, 8-High System	90"W x 27"D	975"	507	6,149.00	545 6,943.00
EFPL42832	3/2, 42"W, 8-High System	137"W x 27"D	1625"	840	10,309.00	903 11,638.00
EFPL42843	4/3, 42"W, 8-High System	180"W x 27"D	2275"	1,164	14,169.00	1,252 15,973.00
EFPL428211	2/1/1, 42"W, 8-High System	90"W x 42"D	1300"	715	9,601.00	765 10,632.00
EFPL428322	3/2/2, 42"W, 8-High System	137"W x 42"D	2275"	1,243	16,614.00	1,331 18,053.00
EFPL428433	4/3/3, 42"W, 8-High System	180"W x 42"D	3250"	1,756	23,817.00	1,881 26,397.00



2/1 - 2 Rows; 2 Fixed, 1 Movable, 27"D



2/1/1 - 3 Rows; 2 Fixed, 2 Movable, 42"D



3/2 - 2 Rows; 3 Fixed, 2 Movable, 27"D

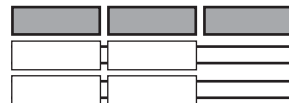

3/2/2 - 3 Rows; 3 Fixed, 4 Movable, 42"D



4/3 - 2 Rows; 4 Fixed, 3 Movable, 27"D



4/3/3 - 3 Rows; 4 Fixed, 6 Movable, 42"D

Office Suites  
Seating  
Tables & Desks  
Meeting Essentials  
Personal Organization  
Ergonomics  
High Density Storage  
Storage & Filing  
Facilities  
Technology Furniture  
Art & Engineering  
K-12 Education  
SAFE Collection Addendum

To increase filing density, 4-Post Shelving can also mount to the Kwik-Track system creating either a bi-file or tri-file lateral sliding shelving system. In either configuration, the rear row of shelves are stationary with shelves in front mounted into a sliding carriage on a track mounted to the floor.

- Heavy-duty aluminum track construction supports 3,500 lbs. per carriage
- Anti-tip built into base for stability and easy installation
- Systems are complete with shelving and track systems
- **Option of ordering with and without Dividers, add "DV" suffix if ordering with dividers**
- Track system has a Brushed Aluminum finish. Floor mounting hardware included
- Optional Security Back Panels available (See page 161)
- Track adds 2¾" to overall height of shelving
- All systems are legal depth, 15" D shelving only, maxium 15 ft.
- Standard Safco® Corporate colors, see page 10

Model No.	Description	Dimensions	LFI	Wt.	Without Dividers List Price	With Dividers Add "DV" Suffix List Price
FFPG36721	2/1, 36"W, 7-High System	78"W x 33"D	728"	405	5,605.00	441 6,439.00
FFPG36732	3/2, 36"W, 7-High System	116"W x 33"D	1212"	665	9,581.00	725 10,722.00
FFPG36743	4/3, 36"W, 7-High System	156"W x 33"D	1697"	924	12,984.00	1,008 14,520.00
FFPG367211	2/1/1, 36"W, 7-High System	78"W x 51"D	970"	578	8,828.00	626 9,657.00
FFPG367322	3/2/2, 36"W, 7-High System	116"W x 51"D	1697"	997	15,608.00	1,081 17,440.00
FFPG367433	4/3/3, 36"W, 7-High System	156"W x 51"D	2424"	1,416	21,991.00	1,536 24,558.00
FFPG36821	2/1, 36"W, 8-High System	78"W x 33"D	824"	452	5,979.00	493 6,882.00
FFPG36832	3/2, 36"W, 8-High System	116"W x 33"D	1385"	714	10,194.00	782 11,699.00
FFPG36843	4/3, 36"W, 8-High System	156"W x 33"D	1939"	1,030	13,812.00	1,125 15,860.00
FFPG368211	2/1/1, 36"W, 8-High System	78"W x 51"D	1108"	642	9,315.00	696 10,277.00
FFPG368322	3/2/2, 36"W, 8-High System	116"W x 51"D	1939"	1,079	16,459.00	1,174 18,510.00
FFPG368433	4/3/3, 36"W, 8-High System	156"W x 51"D	2770"	1,573	23,205.00	1,708 26,128.00
FFPG42721	2/1, 42"W, 7-High System	90"W x 33"D	854"	504	6,154.00	540 6,849.00
FFPG42732	3/2, 42"W, 7-High System	137"W x 33"D	1422"	833	10,559.00	893 11,916.00
FFPG42743	4/3, 42"W, 7-High System	180"W x 33"D	1991"	1,156	14,227.00	1,240 15,738.00
FFPG427211	2/1/1, 42"W, 7-High System	90"W x 51"D	1138"	714	9,427.00	762 10,649.00
FFPG427322	3/2/2, 42"W, 7-High System	137"W x 51"D	1991"	1,239	17,093.00	1,323 18,922.00
FFPG427433	4/3/3, 42"W, 7-High System	180"W x 51"D	2844"	1,753	23,888.00	1,873 26,455.00
FFPG42821	2/1, 42"W, 8-High System	90"W x 33"D	975"	564	6,585.00	605 7,484.00
FFPG42832	3/2, 42"W, 8-High System	137"W x 33"D	1625"	931	11,264.00	999 12,768.00
FFPG42843	4/3, 42"W, 8-High System	180"W x 33"D	2275"	1,293	15,182.00	1,388 17,228.00
FFPG428211	2/1/1, 42"W, 8-High System	90"W x 51"D	1300"	795	10,187.00	849 11,127.00
FFPG428322	3/2/2, 42"W, 8-High System	137"W x 51"D	2275"	1,380	18,072.00	1,475 20,120.00
FFPG428433	4/3/3, 42"W, 8-High System	180"W x 51"D	3250"	1,955	24,813.00	2,090 27,679.00



2/1 - 2 Rows; 2 Fixed, 1 Movable, 33"D



2/1/1 - 3 Rows; 2 Fixed, 2 Movable, 51"D



3/2 - 2 Rows; 3 Fixed, 2 Movable, 33"D

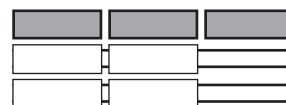

3/2/2 - 3 Rows; 3 Fixed, 4 Movable, 51"D

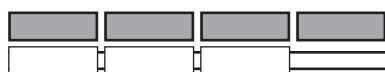

4/3 - 2 Rows; 4 Fixed, 3 Movable, 33"D

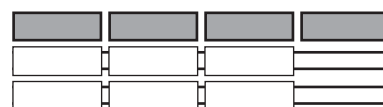

4/3/3 - 3 Rows; 4 Fixed, 6 Movable, 51"D

# Heavy-Duty Shelving

Safco® Products marketing materials are designed to be used as sales tools for our Dealer network.

A complete starter section unit includes two uprights, five shelves (24", 30", 36", 42" or 48" wide), five common stops, twelve shelf supports, shelf reinforcements as required, and one canopy top. Shelves are 18-gauge steel. An adder unit includes the previously mentioned paired with one closed upright.

Choose from either closed "L" uprights or closed "T" uprights. "T" uprights are normally for internal range support, while closed "L" uprights provide a more finished external appearance.

- 800 lb. weight capacity per shelf
- 15¾" clearance between shelves
- Standard Safco® Corporate colors, see page 10

Dividers are required when using standard common stops, add "DV" suffix when ordering with dividers

**Option of ordering with and without Dividers, add "DV" suffix if ordering with dividers**

Compatible with Mobile Aisle 1000 and Mobile Lite, but not Kwik-Track

## Product Numbering System for 4-Post Shelving

Product No. Example: **EXL3618865S**  
**EX:** Heavy-Duty Shelving  
**L or T:** Shelving Type: ("L" for Closed L-Uprights, "T" for Closed T-Uprights)  
**36:** Shelving Width in Inches (24, 30, 36, 42, and 48)  
**18:** Shelving Depth in Inches (18 and 36)  
**86:** Upright Height in Inches (only one height)  
**5:** Number of shelves  
**S:** Starter

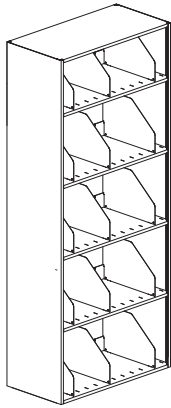

### Starter Units with Two Closed "L" Uprights

Model No.	W	D	H	Wt.	Without Dividers List Price	With Dividers Add "DV" Suffix List Price
EXL2418865S	24"	18"	86"	136	1,729.00	147 2,205.00
EXL2436865S	24"	36"	86"	276	2,799.00	287 3,753.00
EXL3018865S	30"	18"	86"	169	1,648.00	180 2,115.00
EXL3036865S	30"	36"	86"	303	2,821.00	314 3,775.00
EXL3618865S	36"	18"	86"	172	1,725.00	183 2,236.00
EXL3636865S	36"	36"	86"	331	2,849.00	342 3,732.00
EXL4218865S	42"	18"	86"	190	1,714.00	201 2,183.00
EXL4236865S	42"	36"	86"	357	2,861.00	368 3,814.00
EXL4818865S	48"	18"	86"	211	1,761.00	222 2,226.00
EXL4836865S	48"	36"	86"	388	2,920.00	399 3,874.00

### Option of ordering with and without Dividers, add "DV" suffix if ordering with dividers

### Adder units with Closed "T" Uprights

Model No.	W	D	H	Wt.	Without Dividers List Price	With Dividers Add "DV" Suffix List Price
EXT2418865A	24"	18"	86"	125	1,619.00	136 2,097.00
EXT2436865A	24"	36"	86"	216	2,455.00	227 3,410.00
EXT3018865A	30"	18"	86"	143	1,542.00	154 2,050.00
EXT3036865A	30"	36"	86"	243	2,477.00	254 3,430.00
EXT3618865A	36"	18"	86"	161	1,618.00	172 2,130.00
EXT3636865A	36"	36"	86"	271	2,509.00	282 3,394.00
EXT4218865A	42"	18"	86"	179	1,642.00	190 2,118.00
EXT4236865A	42"	36"	86"	297	2,519.00	308 3,471.00
EXT4818865A	48"	18"	86"	201	1,656.00	212 2,165.00
EXT4836865A	48"	36"	86"	328	2,577.00	339 3,532.00

Model No.	W	D	Wt.	List Price
<b>Closed "L" Uprights – 86" Height</b>				
X1886L		18"	31	257.00

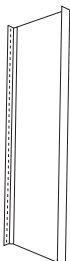
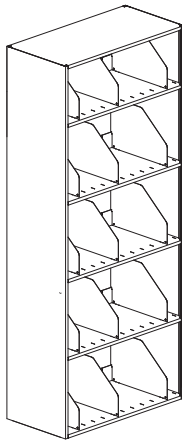

Office Suites  
Seating  
Tables & Desks  
Meeting Essentials  
Personal Organization  
Ergonomics  
High Density Storage  
Storage & Filing  
Facilities  
Technology Furniture  
Art & Engineering  
K-12 Education  
SAFE Collection Addendum

Model No.	W	D	Wt.	List Price
<b>Slotted Shelves</b>				
<b>18" Depth</b>				
EX3018S	30"	18"	8.75	83.00
EX3618S	36"	18"	10.25	98.00
EX4218S	42"	18"	12	93.00
EX4818S	48"	18"	13.75	103.00
<b>36" Depth</b>				
EX3036S	30"	36"	16.5	175.00
EX3636S	36"	36"	19.75	179.00
EX4236S	42"	36"	22.75	179.00
EX4836S	48"	36"	26	192.00

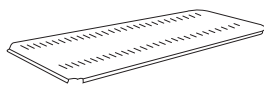

Note: Order three supports per shelf. Shelves are 18-gauge.

### Unslotted Shelves, or Canopy Top

Model No.	W	D	Wt.	List Price
<b>18" Depth</b>				
EF3018U18GA	30"	18"	8.75	98.00
EF3618U18GA	36"	18"	10.25	105.00
EF4218U18GA	42"	18"	12	105.00
EF4818U18GA	48"	18"	13.75	101.00
<b>36" Depth</b>				
EF3036U18GA	30"	36"	16.5	204.00
EF3636U18GA	36"	36"	19.5	203.00
EF4236U18GA	42"	36"	22.75	203.00
EF4836U18GA	48"	36"	26	208.00



Note: Shelves are 18-gauge. Shelf Reinforcements are not required for the Canopy tops.

Model No.	W	H	Wt.	List Price
<b>Common Stops (CS)</b>				
EF24CS	24"	3 1/2"	1.25	14.00
EF30CS	30"	3 1/2"	1.5	14.00
EF36CS	36"	3 1/2"	1.5	14.00
EF42CS	42"	3 1/2"	1.75	15.00
EF48CS	48"	3 1/2"	2	15.00

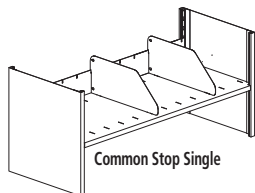

Note: Dividers are required when using common stops.

Model No.	W	H	Wt.	List Price
<b>Shelf Supports (SS)</b>				
EX30SS	30"	1 1/4"	3	34.00
EX36SS	36"	1 1/4"	3.5	34.00
EX42SS	42"	1 1/4"	4	34.00
EX48SS	48"	1 1/4"	4.5	34.00

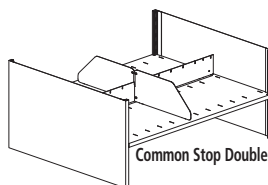

Note: Shelf supports are not interchangeable with bottom shelf supports.

Model No.	W	H	Wt.	List Price
<b>Shelf Support Bottom (SSB)</b>				
EF2411SSB	24"	3/4"	3.66	18.00
EF3011SSB	30"	3/4"	2.25	18.00
EF3611SSB	36"	3/4"	2.714	18.00
EF4211SSB	42"	3/4"	3.25	18.00
EF4811SSB	48"	3/4"	3.66	25.00

Note: Bottom shelf must be supported by bottom shelf. Graphite Gray only.

Model No.	D	H	Wt.	List Price
<b>Shelf Reinforcements (SR) - Indicate color to match system</b>				
X18SR	18"	1 1/8"	1	24.00
X36SR	36"	1 1/8"	1.5	24.00

Note: (SR) Painted to match shelving ordered.

Model No.	D	H	Wt.	List Price
<b>Shelf Reinforcements (SRA) - Bottom shelf reinforcements for heavy-duty applications</b>				
F18SRA	18"	3/4"	.75	14.00
F36SRA	36"	3/4"	1.5	17.00

### Adjustable File Dividers (DV) Standard Pack of 5:

X18DV5	18"	12"	13 lbs. per pack	164.00
--------	-----	-----	------------------	--------

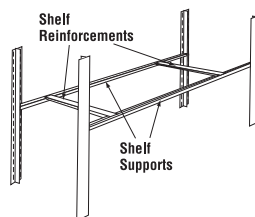

	24"	30"	36"	42"	48"
18"	2	2	2	2	2
36"	3	3	3	3	3

Number of Shelf Reinforcements required per loaded shelf.

# File Harbor Cabinets

Safco® Products marketing materials are designed to be used as sales tools for our Dealer network.

- Horizontally sliding tambour doors. Doors recede into concealed inner pockets
- 100% access to files
- Adjustable shelves and dividers – shelves adjust on 1" H increments
- Shelf depth 14¾"; interior depth 16½"; 10" clearance between shelves
- All internal components standard in Graphite finish
- For cabinets to be keyed alike, add a "K" to the end of the model number and refer to last column for list price

**Interior Heights:**  
 83" H = 76" H interior  
 62" H = 55" H interior  
 38" H = 34" H interior

Standard door colors: Mist, Graphite, Pebble Gray and Sand only

See page 10 for Safco Corporate Color Program, Laminates and Paint colors or go to Safco website to view color swatches

## File Harbor Cabinets - 83" Height (76" Interior Height)

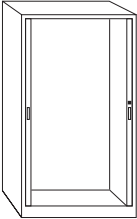
Model No.	Description	W	Size H	D	Wt.	List Price	List Price Add "K" Suffix Keyed-Alike
<b>Empty Cabinet – built-in bottom shelf; add other components</b>							
 83483	48" W x 83" H	47¼"	83"	17¾"	245	4,941.00	5,059.00
83423	42" W x 83" H	42"	83"	17¾"	220	4,611.00	4,730.00
83363	36" W x 83" H	36"	83"	17¾"	200	4,159.00	4,277.00

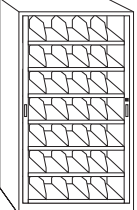
Model No.	Description	W	Size H	D	Wt.	List Price	List Price Add "K" Suffix Keyed-Alike
<b>Preconfigured Cabinet for color-coded end-tab filing. Includes 7 shelves with adjustable filing dividers</b>							
 8348A3	48" W x 83" H 4 dividers per shelf.	47¼"	83"	17¾"	355	6,802.00	6,924.00
8342A3	42" W x 83" H 3 dividers per shelf.	42"	83"	17¾"	325	6,420.00	6,539.00
8336A3	36" W x 83" H 3 dividers per shelf.	36"	83"	17¾"	290	5,914.00	6,104.00

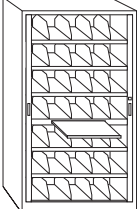
Model No.	Description	W	Size H	D	Wt.	List Price	List Price Add "K" Suffix Keyed-Alike
<b>Same as above except one standard shelf replaced with pull-out reference shelf</b>							
 8348B3	48" W x 83" H 4 dividers per shelf.	47¼"	83"	17¾"	364	7,170.00	7,290.00
8342B3	42" W x 83" H 3 dividers per shelf.	42"	83"	17¾"	333	6,652.00	6,775.00
8336B3	36" W x 83" H 3 dividers per shelf.	36"	83"	17¾"	298	6,324.00	6,445.00
912089R	Master Key				1	91.00	

## File Harbor Cabinets - 62" Height (55" Interior Height)

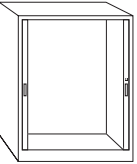
Model No.	Description	W	Size H	D	Wt.	List Price	List Price Add "K" Suffix Keyed-Alike
<b>Empty 62" H Cabinet – built-in bottom shelf; add other components</b>							
 62483	48" W x 62" H	47¼"	61½"	17¾"	200	4,051.00	4,170.00
62423	42" W x 62" H	42"	61½"	17¾"	188	3,698.00	3,929.00
62363	36" W x 62" H	36"	61½"	17¾"	175	3,652.00	3,774.00

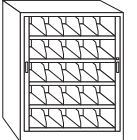
Model No.	Description	W	Size H	D	Wt.	List Price	List Price Add "K" Suffix Keyed-Alike
<b>Preconfigured Cabinet for color-coded end-tab filing. Includes 5 shelves with adjustable filing dividers</b>							
 6248A3	48" W x 62" H 4 dividers per shelf.	47¼"	61½"	17¾"	284	5,440.00	5,563.00
6242A3	42" W x 62" H 3 dividers per shelf.	42"	61½"	17¾"	262	5,112.00	5,234.00
6236A3	36" W x 62" H 3 dividers per shelf.	36"	61½"	17¾"	237	4,886.00	5,004.00

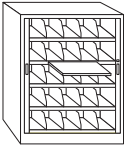
Model No.	Description	W	Size H	D	Wt.	List Price	List Price Add "K" Suffix Keyed-Alike
<b>Same as above except one standard shelf replaced with pull-out reference shelf</b>							
 6248B3	48" W x 62" H 4 dividers per shelf.	47¼"	61½"	17¾"	298	5,975.00	6,100.00
6242B3	42" W x 62" H 3 dividers per shelf.	42"	61½"	17¾"	274	5,469.00	5,585.00
6236B3	36" W x 62" H 3 dividers per shelf.	36"	61½"	17¾"	247	5,227.00	5,348.00

Office Suites, Seating, Tables & Desks, Meeting Essentials, Personal Organization, Ergonomics, High Density Storage, Storage & Filing, Facilities, Technology Furniture, Art & Engineering, K-12 Education, SAFE Collection Addendum

## File Harbor Cabinets - 38" Height (34" Interior Height)

Model No.	Description	W	Size H	D	Wt.	List Price	List Price Add "K" Suffix Keyed-Alike
<b>Empty 38"H Cabinet – built-in bottom shelf; add other components</b>							
38483	48"W x 38"H	47 <sup>1</sup> / <sub>4</sub> "	38"	17 <sup>3</sup> / <sub>4</sub> "	100	3,623.00	3,743.00
38423	42"W x 38"H	42"	38"	17 <sup>3</sup> / <sub>4</sub> "	90	3,505.00	3,625.00
38363	36"W x 38"H	36"	38"	17 <sup>3</sup> / <sub>4</sub> "	80	3,393.00	3,511.00

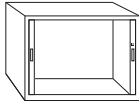

Model No.	Description	W	Size H	D	Wt.	List Price	List Price Add "K" Suffix Keyed-Alike
<b>Preconfigured Cabinet for color coded – end tab filing. Includes 3 shelves with adjustable filing components</b>							
3848A3	48"W x 38"H 4 dividers per shelf	47 <sup>1</sup> / <sub>4</sub> "	38"	17 <sup>3</sup> / <sub>4</sub> "	142	4,393.00	4,512.00
3842A3	42"W x 38"H 3 dividers per shelf	42"	38"	17 <sup>3</sup> / <sub>4</sub> "	130	4,228.00	4,347.00
3836A3	36"W x 38"H 3 dividers per shelf	36"	38"	17 <sup>3</sup> / <sub>4</sub> "	105	4,070.00	4,191.00

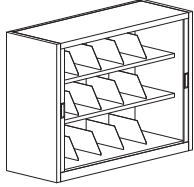

## File Harbor Components

- Shelves have a 200 lb. weight capacity
- Reference shelves have a 100 lb. weight capacity
- Dividers adjust on 2.5" increments

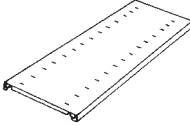
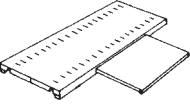
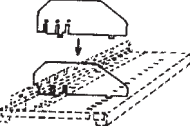

Model No.	Description	W	Size H	D	Wt.	List Price	
<ul style="list-style-type: none"> <li>• Shelves have a 200 lb. weight capacity</li> </ul> 	MS4801	42" Shelf (Fits 48"W cabinet)	42"	1"	14 <sup>3</sup> / <sub>4</sub> "	232.00	
	MS4802	Package of 2 shelves				30	413.00
	MS4803	Package of 3 shelves				45	624.00
	MS4201	37" Shelf (Fits 42"W cabinet)	36 <sup>3</sup> / <sub>4</sub> "	1"	14 <sup>3</sup> / <sub>4</sub> "	13	199.00
	MS4202	Package of 2 shelves				26	384.00
	MS4203	Package of 3 shelves				39	577.00
	MS3601	31" Shelf (Fits 36"W cabinet)	30 <sup>3</sup> / <sub>4</sub> "	1"	14 <sup>3</sup> / <sub>4</sub> "	11	185.00
	MS3602	Package of 2 shelves				22	350.00
	MS3603	Package of 3 shelves				33	509.00
	911196R	Replacement Shelf Hook, 4 pc.				1	116.00
<ul style="list-style-type: none"> <li>• Reference shelves have a 100 lb. weight capacity</li> </ul> 	MRS48	42" Reference Shelf (Fits 48"W cabinet) Same as MS48 but with 18"W x 11"D pull-out slide	42"	1"	14 <sup>3</sup> / <sub>4</sub> "	30	829.00
	MRS42	37" Reference Shelf (Fits 42"W cabinet)	36 <sup>3</sup> / <sub>4</sub> "	1"	14 <sup>3</sup> / <sub>4</sub> "	27	815.00
	MRS36	31" Reference Shelf (Fits 36"W cabinet)	30 <sup>3</sup> / <sub>4</sub> "	1"	14 <sup>3</sup> / <sub>4</sub> "	23	773.00
<ul style="list-style-type: none"> <li>• Dividers adjust on 2 1/2" increments</li> </ul> 	MFD48	Adjustable Filing Dividers (Fits 42"W shelf) 4 adjustable filing dividers and 1 backstop for separating file folders	—	6"	13"	4.8	131.00
	MFD42	Adjustable Filing Dividers (Fits 37"W shelf) 3 adjustable filing dividers and 1 backstop for separating file folders	—	6"	13"	4.3	125.00
	MFD36	Adjustable Filing Dividers (Fits 31"W shelf) Same as above	—	6"	13"	3.8	114.00
	MFD4	Set of 4 Extra Filing Dividers No backstop	—	6"	13"	4.0	114.00

Office Suites  
Seating  
Tables & Desks  
Meeting Essentials  
Personal Organization  
Ergonomics  
High Density Storage  
Storage & Filing  
Facilities  
Technology Furniture  
Art & Engineering  
Education  
K-12  
SAFE Collection Addendum

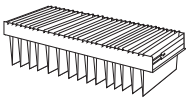

# File Harbor Cabinet Components - Roll-Out Frame

Safco® Products marketing materials are designed to be used as sales tools for our Dealer network.

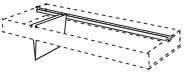
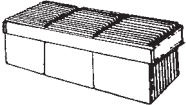
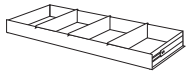
Model No.	Description	W	Size H	D	Wt.	List Price
<b>Note:</b> Interlock mechanism included with each roll-out						
	<b>MRF482 Roll-Out Frame</b> (Fits 48"W cabinet) 39 1/4 filing inches For legal-size hanging folders, print-outs, etc., side-to-side format. To accommodate letter-size hanging folders, add MCM481	40 3/4"	3 3/4"	15 3/4"	18	785.00
	<b>MRF422 Roll-Out Frame</b> (Fits 42"W cabinet) 34 filing inches To accommodate letter-size folders, add MCM421	35 3/4"	3 3/4"	15 3/4"	17	794.00
	<b>MRF362 Roll-Out Frame</b> (Fits 36"W cabinet) 28 filing inches. To accommodate letter-size folders, add MCM361	29 3/4"	3 3/4"	15 3/4"	15	765.00
	<b>MCM Cross-Member (front-to-back)</b> Creates separations within Roll-Out Frame for filing front to back	1 1/2"	3/4"	15 3/4"	1	102.00
	<b>MCM481 Cross-Member (side-to-side)</b> (Fits MRF482) For filing letter-size hanging folders side-to-side	40 3/4"	3/4"	1 1/2"	2	299.00
	<b>MCM421 Cross-Member (side-to-side)</b> (Fits MRF422)	35 3/4"	3/4"	1 1/2"	2	269.00
	<b>MCM361 Cross-Member (side-to-side)</b> (Fits MRF362)	29 3/4"	3/4"	1 1/2"	2	231.00
	<b>MRP482 Roll-Out Frame for Pendaflex</b> Fits 48"W cabinet Includes 2 Cross-Members; provides 3 rows of letter-size Pendaflex (45 filing inches)	40 3/4"	3 3/4"	15 3/4"	20	1,050.00
	<b>MRP422 Roll-Out Frame for Pendaflex</b> Fits 42"W cabinet Includes 2 Cross-Members; provides 2 rows of letter-size Pendaflex (30 filing inches)	35 3/4"	3 3/4"	15 3/4"	19	1,018.00
	<b>MRP362 Roll-Out Frame for Pendaflex</b> Fits 36"W cabinet Includes 2 Cross-Members; provides 2 rows of letter-size Pendaflex (30 filing inches)	29 3/4"	3 3/4"	15 3/4"	17	905.00
	<b>MRD482 Roll-Out Drawer with Dividers</b> Fits 48"W cabinet For storage of diskettes, other media 3 dividers provided (adjust on 1/4" increments)	40 3/4"	3 3/4"	15 3/4"	27	1,260.00
(125# capacity)		<b>Interior:</b> 39"	—	15 1/8"		
	<b>MRD422 Roll-Out Drawer with Dividers</b> Fits 42"W cabinet	35 3/4"	3 3/4"	15 3/4"	25	1,198.00
		<b>Interior:</b> 33 3/4"	—	15 1/8"		
	<b>MRD362 Roll-Out Drawer with Dividers</b> (Fits 36"W cabinet)	29 3/4"	3 3/4"	15 3/4"	23	1,130.00
		<b>Interior:</b> 27 3/4"	—	15 1/8"		
	<b>MDV Set of 3 Extra Dividers For Roll-Out Drawers</b>		—		3.3	152.00

Office Suites  
Seating  
Tables & Desks  
Meeting Essentials  
Personal Organization  
Ergonomics  
High Density Storage  
Storage & Filing  
Facilities  
Technology Furniture  
Art & Engineering  
K-12 Education  
SAFE Collection Addendum

## File Harbor Cabinet Components - Master Shelf

Model No.	Description	W	Size H	D	Wt.	List Price
MOS48	<b>42" Master Shelf</b> Fits 48"W cabinet To build 41"W file organizing system; accepts shelf supports, dividers, in 1" increments	42"	5 1/4"	14 3/4"	12	443.00
MOS42	<b>37" Master Shelf</b> Fits 42" cabinet Same as above except builds 36"W organizing system	36 3/4"	5 1/4"	14 3/4"	11	432.00
MOS36	<b>31" Master Shelf</b> Fits 36" cabinet Same as above except builds 30"W organizing system	30 3/4"	5 1/4"	14 3/4"	9	401.00
SS12LC	<b>Shelf Support</b> Supports shelves (below) on 1/2" vertical increments; mounts on Master Shelf (Not compatible with MS48/MS36 shelves)	—	12"	12"	1.5	53.00
D09GS03	<b>Dividers - package of 3</b> To separate binders, manuals, etc.	—	9"	13 1/2"	6.9	112.00
D09GS10	<b>Dividers - package of 10</b>	—	9"	13 1/2"	23	369.00

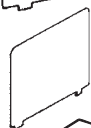
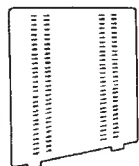
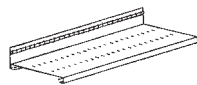

### Kwik Shelf® Shelving System

- Shelves fit between Shelf Supports to create sorting or storage pockets for paper, forms or other media
- Each shelf locks firmly in place, yet removes quickly for easy reconfiguration
- Shelves are 18-gauge

Width	Depth	Wt. per shelf	6-Shelf Package	
			Model No.	List Price
4"	12"	.5	0412P06	139.00
5"	12"	.75	0512P06	149.00
6"	12"	.75	0612P06	154.00
7"	12"	1.0	0712P06	162.00
8"	12"	1.05	0812P06	191.00
9"	12"	1.05	0912P06	210.00
10"	12"	1.15	1012P06	222.00
11"	12"	1.25	1112P06	235.00
12"	12"	1.4	1212P06	238.00
14"	12"	2.3	1412P06	326.00
16"	12"	2.8	1612P06	376.00

To increase filing density, File Harbor Cabinets can also mount to the Kwik-Track system creating either a bi-file or tri-file lateral sliding cabinet system. In either configuration, the rear of the cabinets are stationary with cabinets in front mounted into a sliding carriage on a track mounted to the floor.

- Heavy-duty aluminum track construction supports 3,500 lbs. per carriage
- Anti-tip arm built into base for stability and easy installation
- Systems are complete with pre-configured cabinets and track systems
- Track system has a Brushed Aluminum finish
- Floor mounting hardware included
- Track adds 2<sup>3</sup>/<sub>4</sub>" to overall height of system
- Dividers included

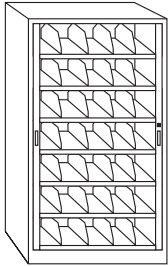

8342A3 cabinet

Model No.	Description	Dimensions	Wt.	LFI	List Price
<b>36" W options use 8336A3 cabinets</b>					
FH3621	2/1 System	78"W x 38 <sup>1</sup> / <sub>2</sub> " D x 85"H	905	651"	18,468.00
FH3632	3/2 System	116"W x 38 <sup>1</sup> / <sub>2</sub> " D x 85"H	1,520	1085"	31,711.00
FH3643	4/3 System	156"W x 38 <sup>1</sup> / <sub>2</sub> " D x 85"H	2,135	1519"	44,363.00
<b>42" W options use 8342A3 cabinets</b>					
FH4232	3/2 System	116"W x 59 <sup>1</sup> / <sub>4</sub> " D x 85"H	2,170	1519"	46,893.00
FH36433	4/3 System	156"W x 59 <sup>1</sup> / <sub>4</sub> " D x 85"H	3,110	2170"	66,691.00
<b>48" W options use 8348A3 cabinets</b>					
FH48433	4/3 System	198"W x 59 <sup>1</sup> / <sub>4</sub> " D x 85"H	3,700	2940"	79,729.00
912089R	Master Key for above Cabinet Systems	—	1		91.00



2/1 - 2 Rows; 2 Fixed, 1 Movable, 38<sup>1</sup>/<sub>2</sub>" D



3/2 - 2 Rows; 3 Fixed, 2 Movable, 38<sup>1</sup>/<sub>2</sub>" D



4/3 - 2 Rows; 4 Fixed, 3 Movable, 38<sup>1</sup>/<sub>2</sub>" D



2/1/1 - 3 Rows; 2 Fixed, 2 Movable, 59<sup>1</sup>/<sub>4</sub>" D

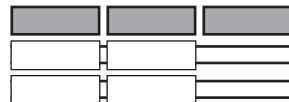

3/2/2 - 3 Rows; 3 Fixed, 4 Movable, 59<sup>1</sup>/<sub>4</sub>" D

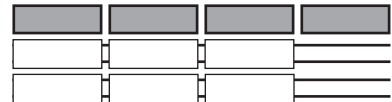

4/3/3 - 3 Rows; 4 Fixed, 6 Movable, 59<sup>1</sup>/<sub>4</sub>" D

- Separate binders or other media
- Place on adjustable master shelves or cabinet bottom on 1" horizontal increments

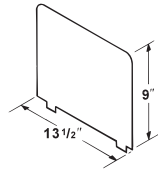

Model No.	Wt./Cartons	List Price
<b>D09GS03 (3)</b>	6.9 lbs. / 1 ctn.	112.00
<b>D09GS10 (10)</b>	23 lbs. / 1 ctn.	369.00

Forms/Storage Cabinets - Shelf Supports

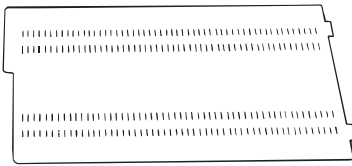

- Not needed at sides of cabinet where shelf support is built in
- Place on cabinet bottom or adjustable master shelves on 1" horizontal increments

Label Holders

- Transparent Label Holders have a self-adhesive, magnetic, or velcro backing and fit securely on beveled shelf front
- A blank insert with four sides is included
- Package of 20

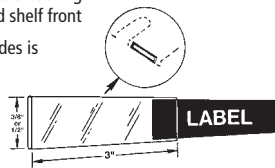

Model No.	Height	Depth	For Shelf Depth of	Wt.	List Price
<b>SS24LM01</b>	21"	11 1/4"	12"	4.7	81.00
<b>SS24GM01</b>	21"	14"	15"	5.3	99.00
<b>SS33LM01</b>	30"	11 1/4"	12"	6	91.00
<b>SS33GM01</b>	30"	14"	15"	7	117.00
<b>SS41LM01</b>	38"	11 1/4"	12"	7.3	113.00
<b>SS41GM01</b>	38"	14"	15"	8.4	131.00
<b>SS48LM01</b>	45"	11 1/4"	12"	8.4	131.00
<b>SS48GM01</b>	45"	14"	15"	9.7	159.00
<b>SS65LS101</b>	57"	11 1/4"	12"	10.6	174.00
<b>SS65GS101</b>	57"	14"	15"	12.3	251.00
<b>SS80LS101</b>	72"	11 1/4"	12"	13	237.00
<b>SS80GS101</b>	72"	14"	15"	15	300.00

Model No.	Description	Width	Height	Wt.	List Price
<b>90145</b>	Self-adhesive	3"	3/8"	1 oz.	49.00
<b>911785</b>	Magnetic	3"	1/2"	3 oz.	73.00
<b>922VEL</b>	Velcro	3"	1/2"	3 oz.	4.00

Forms/Storage Cabinets - Shelves

Contact your local Safco Sales Rep Group to discuss space planning specific application, obtain prior approval and quote.

Kwik-Shelf® Shelving System

- Shelves fit between Shelf Supports to create sorting or storage pockets for paper, forms or other media
- Each shelf locks firmly in place, yet removes quickly for easy reconfiguration
- Shelves are 20-gauge

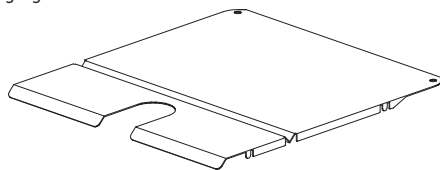

6-Shelf Package

Model No.	Width	Depth	Wt. per shelf	List Price
<b>0412P06</b>	4"	12"	.5	139.00
<b>0512P06</b>	5"	12"	.75	149.00
<b>0515P06</b>	5"	15"	1.0	155.00
<b>0612P06</b>	6"	12"	.75	154.00
<b>0712P06</b>	7"	12"	1.0	162.00
<b>0812P06</b>	8"	12"	1.05	191.00
<b>0912P06</b>	9"	12"	1.05	210.00
<b>0915P06</b>	9"	15"	2.0	238.00
<b>1012P06</b>	10"	12"	1.15	222.00
<b>1015P06</b>	10"	15"	1.5	254.00
<b>1112P06</b>	11"	12"	1.25	235.00
<b>1115P06</b>	11"	15"	1.65	255.00
<b>1212P06</b>	12"	12"	1.4	238.00
<b>1215P06</b>	12"	15"	1.75	267.00
<b>1412P06</b>	14"	12"	2.3	326.00
<b>1415P06</b>	14"	15"	2.75	353.00
<b>1515P06</b>	15"	15"	2.9	394.00
<b>1612P06</b>	16"	12"	2.8	376.00
<b>1615P06</b>	16"	15"	3.0	412.00

Office Suites  
Seating  
Tables & Desks  
Meeting Essentials  
Personal Organization  
Ergonomics  
High Density Storage  
Storage & Filing  
Facilities  
Technology Furniture  
Art & Engineering  
K-12 Education  
SAFE Collection Addendum

# ARC™ Rotary File & Empty Cabinet

Safco® Products marketing materials are designed to be used as sales tools for our Dealer network.

The ARC™ Rotary File is a double faced unit that rotates easily to provide access to both sides. Using our flexible cantilever style shelving, the ARC provides the most unobstructed filing inches per level and the easiest installation possible. The Complete Starter includes everything needed to house a filing system including the specified number of shelves and dividers. See page 10 Corporate Color Program, paint colors and laminates or go to Safco website to view color swatches.

- Allow 5¼" (letter depth) or 6½" (legal depth) clearance from wall for rotating carriage
- Empty units can be configured in endless variations for mixed media storage solutions
- Alley clearance needed 36"
- Shelves adjust on 1½" H increments; 120 lb. weight capacity per shelf
- Complete Units are ideal for storing color-coded filing
- To order a fully assembled unit, add the letter "B" after the letter "C" in the part number (e.g. ARCB24403S)
- ARC top is unfinished. Work surfaces are available - See page 182
- Complete units have slotted shelves with two (2) file dividers per 24" wide shelf; three (3) file dividers per 30" wide shelf
- S: Starter, A: Adder
- Standard Lock on all cabinets comes keyed alike
- Adder units attach to either right or left side of starter unit

## PRECONFIGURED IDEA STARTERS

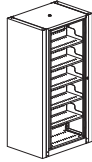

Model No.	W	D	H	Wt.	Knockdown List Price	Assembled Model No.	Assembled List Price "B"
<b>6-Tier Complete</b>							
<b>Letter (288 LFI)</b>							
ARC24726S	37¼"	26¼"	73"	403	5,519.00	ARCB24726S	6,292.00
ARC24726A	31¾"	26¼"	73"	347	5,061.00	ARCB24726A	5,833.00
<b>Legal (360 LFI)</b>							
ARC30726S	46"	32¼"	73"	542	6,974.00	ARCB30726S	7,755.00
ARC30726A	39¼"	32¼"	73"	478	6,426.00	ARCB30726A	7,217.00

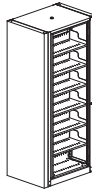

<b>7-Tier Complete</b>							
<b>Letter (336 LFI)</b>							
ARC24827S	37¼"	26¼"	83½"	427	6,249.00	ARCB24827S	7,035.00
ARC24827A	31¾"	26¼"	83½"	365	5,742.00	ARCB24827A	6,524.00
<b>Legal (420 LFI)</b>							
ARC30827S	46"	32¼"	83½"	588	7,750.00	ARCB30827S	8,523.00
ARC30827A	39¼"	32¼"	83½"	516	6,991.00	ARCB30827A	7,908.00

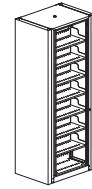

<b>8-Tier Complete</b>							
<b>Letter (384 LFI)</b>							
ARC24938S	37¼"	26¼"	94"	478	7,013.00	N/A	N/A
ARC24938A	31¾"	26¼"	94"	408	6,463.00	N/A	N/A
<b>Legal (480 LFI)</b>							
ARC30938S	46"	32¼"	94"	632	8,555.00	N/A	N/A
ARC30938A	39¼"	32¼"	94"	550	7,958.00	N/A	N/A

## ARC™ Rotary File - Empty Cabinet

See page 10 for Safco Corporate Color Program, Laminates and Paint colors or go to Safco website to view color swatches  
Contact your local Safco Sales Rep Group to discuss space planning specific application, obtain prior approval and quote.



Model No.	W	D	H	Wt.	Knockdown List Price	Assembled Model No.	Assembled List Price "B"
<b>6-Tier Empty</b>							
<b>Letter</b>							
ARC24726ES	37¼"	26¼"	73"	303	4,295.00	ARCB24726ES	5,053.00
ARC24726EA	31¾"	26¼"	73"	247	3,852.00	ARCB24726EA	4,704.00
<b>Legal</b>							
ARC30726ES	46"	32¼"	73"	399	5,297.00	ARCB30726ES	6,182.00
ARC30726EA	39¼"	32¼"	73"	335	4,861.00	ARCB30726EA	5,644.00

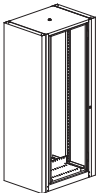

<b>7-Tier Empty</b>							
<b>Letter</b>							
ARC24827ES	37¼"	26¼"	83½"	323	4,912.00	ARCB24827ES	5,529.00
ARC24827EA	31¾"	26¼"	83½"	261	4,407.00	ARCB24827EA	5,036.00
<b>Legal</b>							
ARC30827ES	46"	32¼"	83½"	423	5,930.00	ARCB30827ES	6,634.00
ARC30827EA	39¼"	32¼"	83½"	351	5,343.00	ARCB30827EA	6,053.00

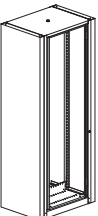

<b>8-Tier Empty</b>							
<b>Letter</b>							
ARC24938ES	37¼"	26¼"	94"	345	5,470.00	N/A	N/A
ARC24938EA	31¾"	26¼"	94"	275	4,935.00	N/A	N/A
<b>Legal</b>							
ARC30938ES	46"	32¼"	94"	437	6,648.00	N/A	N/A
ARC30938EA	39¼"	32¼"	94"	355	5,934.00	N/A	N/A

• Not available assembled

Contact your local Safco Sales Rep Group to discuss space planning specific application, obtain prior approval and quote.

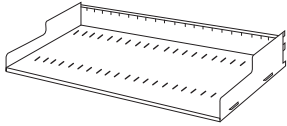
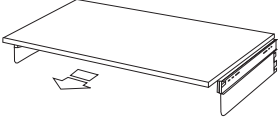
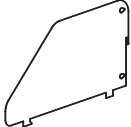
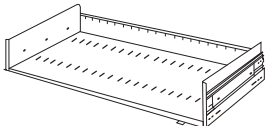
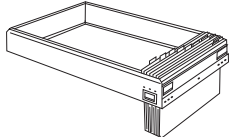
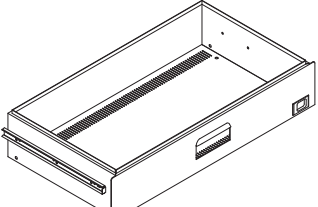
	Model No.	W	H	D	Wt.	List Price
	<b>Slotted Shelves (SLF)</b>					
	ARC2412SLF	24"	6"	12"	8	111.00
	ARC3015SLF	30"	6"	15"	12	135.00
	<b>Pull Out Reference Shelves (RS)</b>					
	ARC2412RS	24"	—	12"	20	464.00
	ARC3015RS	30"	—	15"	23	486.00
	<b>Adjustable File Dividers(DV) – Standard Pack of 6</b>					
	F12DV6	—	6"	12"	6	67.00
	F15DV6	—	6"	15"	7.5	76.00
	<b>Rollout Shelves (ROSLF)</b>					
	ARC2412ROSLF	24"	6"	12"	22	464.00
	ARC3015ROSLF	30"	6"	15"	25	528.00
<b>Note:</b> When ordering rollout accessories, <b>Upright Rollout Supports</b> must be ordered for each side of the ARC™ Rotary File with installed rollout accessories. (See page 176)						
	<b>Rollout Hanging Frames (ROHF)</b>					
	ARC2412ROHF	24"	—	12"	12.5	464.00
	ARC3015ROHF	30"	—	15"	13.5	484.00
<b>Note:</b> When ordering rollout accessories, <b>Upright Rollout Supports</b> must be ordered for each side of the ARC™ Rotary File with installed rollout accessories. (See page 176)						
	<b>Rollout Drawers (ROD)</b>					
	Model No.		H	D	Wt.	List Price
	ARC2412ROD105		10½"	12"	32	552.00
	ARC3015ROD105		10½"	15"	36	589.00
	ARC2412ROD120		12"	12"	37	600.00
	ARC3015ROD120		12"	15"	41	643.00

**Note:** When ordering rollout accessories, **Upright Rollout Supports** must be ordered for each side of the ARC™ Rotary File with installed rollout accessories. (See below)

Contact your local Safco Sales Rep Group to discuss space planning specific application, obtain prior approval and quote.

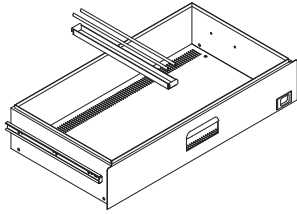

### Converter Bar (CB)

Use with rollout drawers or hanging frame kits  
To file front-to-back, use the following converter bars:

- Sold individually, not in pairs

Model No.	D	Wt.	List Price
ARC12CB	12"	1	101.00
ARC15CB	15"	1	108.00

### Upright Rollout Supports (sold in pairs)

Required on each side of ARC™ Rotary File with Rollout Components

Model No.	Description	List Price
URS6	6-Tier Supports	132.00
URS7	7-Tier Supports	132.00
URS8	8-Tier Supports	132.00

Order 2 pair if filling both sides of the cabinet.

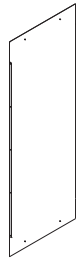

### Center Panels (CP)

Used as security or privacy panel between front and back sections of cabinet.

Model No.	W	H	Wt.	List Price
ARC2472CP	23"	6-tier	19	269.00
ARC3072CP	29"	6-tier	24	285.00
ARC2482CP	23"	7-tier	22	290.00
ARC3082CP	29"	7-tier	28	312.00
ARC2493CP	23"	8-tier	25	336.00
ARC3093CP	29"	8-tier	32	363.00

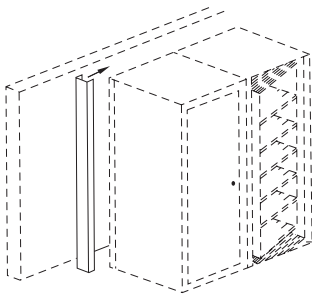

### Wall Closure Strips (WCS)

Closes space between ARC™ unit and wall. Letter: 5 1/4", Legal: 6 1/2".

Model No.	Size	H	Wt.	List Price
ARC2472WCS	LTR	6-tier	18	151.00
ARC3072WCS	LGL	6-tier	20	151.00
ARC2482WCS	LTR	7-tier	23	181.00
ARC3082WCS	LGL	7-tier	28	177.00
ARC2493WCS	LTR	8-tier	27	210.00
ARC3093WCS	LGL	8-tier	30	210.00

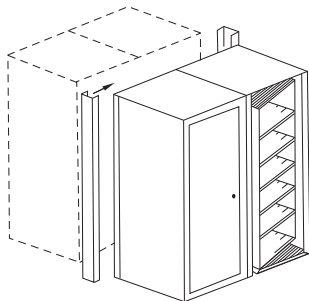

### Back-to-Back Closure Strips (BTB)

Used to enclose the space between two ARC™ units when placed back-to-back.  
Letter: 10 1/2", Legal: 13".

Model No.	Size	H	Wt.	List Price
ARC2472BTB	LTR	6-tier	32	181.00
ARC3072BTB	LGL	6-tier	32	181.00
ARC2482BTB	LTR	7-tier	40	210.00
ARC3082BTB	LGL	7-tier	40	206.00
ARC2493BTB	LTR	8-tier	48	233.00
ARC3093BTB	LGL	8-tier	48	238.00

Contact your local Safco Sales Rep Group to discuss space planning specific application, obtain prior approval and quote.

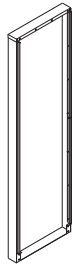

### End Panel Assemblies (EP)

Model No.	Size	H	Wt.	List Price
ARC2472EP	LTR	6-tier	29	731.00
ARC3072EP	LGL	6-tier	33	837.00
ARC2482EP	LTR	7-tier	32	837.00
ARC3082EP	LGL	7-tier	37	849.00
ARC2493EP	LTR	8-tier	36	914.00
ARC3093EP	LGL	8-tier	42	994.00

## Flip-N-File™ Cabinet

- The Flip-n-File™ Cabinet comes fully assembled and ready to use.
- Shelves are fixed with a 9<sup>3</sup>/<sub>4</sub>" H clearance between shelves
- 120 lb. load capacity per shelf
- Inside width dimension of each shelf is 34"
- Accommodates letter or legal filing

- All units come with 4 file dividers per shelf
- Additional dividers are available
- Lock is located at the top of the cabinet
- Standard Finishes: Pebble Gray, Sand Beige and Black Only
- Inside depth is 15<sup>1</sup>/<sub>16</sub>"

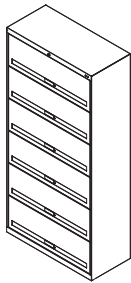

Model No.	Description	W	Size H	D	Wt.	List Price	List Price Add "K" Suffix Keyed Alike
FFD5	5 Tier with Doors	36"	63 <sup>1</sup> / <sub>2</sub> "	17"	160	3,721.00	3,747.00
FFD6	6 Tier with Doors	36"	75 <sup>1</sup> / <sub>4</sub> "	17"	186	4,123.00	4,067.00
FFD7	7 Tier with Doors	36"	87"	17"	212	4,753.00	4,856.00
FFD	Additional Dividers					3.00	-
FFDMK	Master Key				1	34.00	-

Note: For keyed alike cabinets, add a "K" to the end of the model number. See final column for keyed alike pricing (with door only).

## Flip-N-File™ Cabinets on Kwik-Track

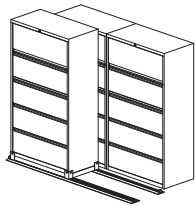

To increase filing density, Flip-n-File™ shelving can also mount to Kwik-Track systems creating either a bi-file or tri-file sliding shelving system. In either configuration, the rear row of cabinets are stationary with cabinets in front mounted on a sliding carriage on a track mounted to floor.

- Heavy-duty aluminum track construction supports 3,500 lbs. per carriage
- Anti-tip built into base for stability and easy installation
- Systems are complete with cabinets and track. Four dividers per shelf are included
- Track system has a Brushed Aluminum finish. Floor mounting hardware included
- Track adds 2<sup>3</sup>/<sub>4</sub>" to overall height of system
- All configurations below have doors

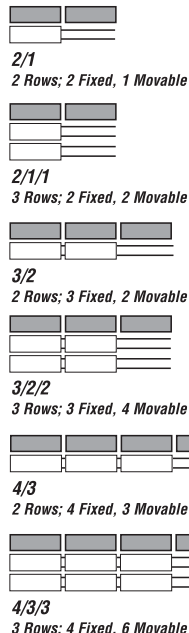

Model No.	Description	Dimensions	Wt.	List Price	List Price Add "K" Suffix Keyed Alike
<b>5-Tier Cabinet 36"D</b>					
FF521	2/1 5-Tier Cabinet	78"W x 36"D x 66 <sup>1</sup> / <sub>4</sub> "H	505	12,854.00	-
FF532	3/2 5-Tier Cabinet	116"W x 36"D x 66 <sup>1</sup> / <sub>4</sub> "H	840	-	22,281.00
FF543	4/3 5-Tier Cabinet	156"W x 36"D x 66 <sup>1</sup> / <sub>4</sub> "H	1,165	30,418.00	-
<b>5-Tier Cabinet 56"D</b>					
FF5322	3/2/2 5-Tier Cabinet	116"W x 56"D x 66 <sup>1</sup> / <sub>4</sub> "H	1,150	33,050.00	-
<b>6-Tier Cabinet 36"D</b>					
FF621	2/1 6-Tier Cabinet	78"W x 36"D x 78"H	583	14,404.00	-
FF632	3/2 6-Tier Cabinet	116"W x 36"D x 78"H	970	24,099.00	24,326.00
<b>6-Tier Cabinet 56"D</b>					
FF6322	3/2/2 6-Tier Cabinet	116"W x 56"D x 78"H	1,332	35,671.00	36,102.00
<b>7-Tier Cabinet 36"D</b>					
FF721	2/1 7-Tier Cabinet	78"W x 36"D x 89 <sup>3</sup> / <sub>4</sub> "H	661	-	16,524.00
FF732	3/2 7-Tier Cabinet	116"W x 36"D x 89 <sup>3</sup> / <sub>4</sub> "H	1,100	26,574.00	-
FF743	4/3 7-Tier Cabinet	156"W x 36"D x 89 <sup>3</sup> / <sub>4</sub> "H	1,529	37,174.00	37,845.00
<b>7-Tier Cabinet 56"D</b>					
FF7211	2/1/1 7-Tier Cabinet	78"W x 56"D x 89 <sup>3</sup> / <sub>4</sub> "H	868	23,078.00	-
FF7322	3/2/2 7-Tier Cabinet	116"W x 56"D x 89 <sup>3</sup> / <sub>4</sub> "H	1,514	39,803.00	-

Note: For keyed alike cabinets, add a "K" to the end of the model number. See final column for keyed alike pricing.



- Standard Finish: Pebble Gray only

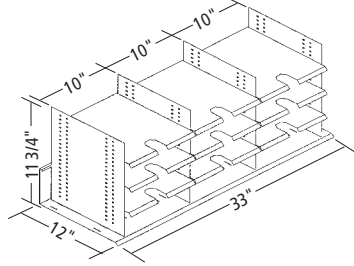

**Manager's System**

Provides 12 pockets, each 10"W x 12"D x 3"H (height adjustable in 1/2" increments)

Model No.	Wt./ Carton	List Price
KB3312D	33 lbs./ 1	686.00

- Standard Finish: Pebble Gray only

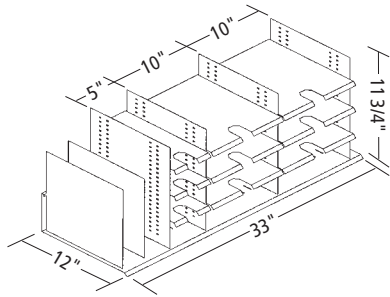

**Administrator's System**

Provides eight 10"W x 12"D x 3"H and four 5"W x 12"D x 3"H pockets (height adjustable in 1/2" increments). Two dividers.

Model No.	Wt./ Carton	List Price
KB3312E	33 lbs. / 1	768.00





- Full drawer extension on steel ball bearing telescoping slides
- All units feature anti-tipping drawer interlock system that allows only one drawer open at a time
- Full width recessed designer drawer pulls
- Side-to-side rails support letter, legal and/or A4 filing
- Top drawer of 5 Drawer Lateral is a roll out shelf
- Extendable posting shelf between third and fourth drawer on 5 Drawer Laterals
- All files ship keyed random
- Features adjustable leveling glides
- Counter weight included to meet ANSI/BIFMA stability requirements
- Optional front-to-back filing rails available (4-pk.), Black only
- Optional divider kit available (10 pk.) Black only
- Available in Black, Medium Tone, Desert Sage, and Mist

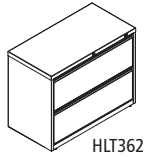
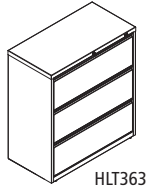
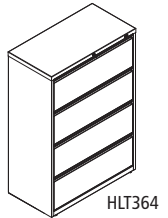
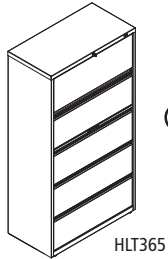

Model No.	Description	Dimensions	Wt.	List Price
<b>5 Drawer Lateral Files</b>				
HLT425	42"W, 5 Drawer Lateral File	42"W x 18 <sup>5</sup> / <sub>8</sub> "D x 67 <sup>5</sup> / <sub>8</sub> "H	230	2,986.00
HLT365	36"W, 5 Drawer Lateral File	36"W x 18 <sup>5</sup> / <sub>8</sub> "D x 67 <sup>5</sup> / <sub>8</sub> "H	202	2,977.00
HLT305	30"W, 5 Drawer Lateral File	30"W x 18 <sup>5</sup> / <sub>8</sub> "D x 67 <sup>5</sup> / <sub>8</sub> "H	179	2,619.00
<b>4 Drawer Lateral Files</b>				
HLT424	42"W, 4 Drawer Lateral File	42"W x 18 <sup>5</sup> / <sub>8</sub> "D x 52 <sup>1</sup> / <sub>2</sub> "H	195	2,501.00
HLT364	36"W, 4 Drawer Lateral File	36"W x 18 <sup>5</sup> / <sub>8</sub> "D x 52 <sup>1</sup> / <sub>2</sub> "H	174	2,216.00
HLT304	30"W, 4 Drawer Lateral File	30"W x 18 <sup>5</sup> / <sub>8</sub> "D x 52 <sup>1</sup> / <sub>2</sub> "H	148	1,923.00
<b>3 Drawer Lateral Files</b>				
HLT423	42"W, 3 Drawer Lateral File	42"W x 18 <sup>5</sup> / <sub>8</sub> "D x 40 <sup>1</sup> / <sub>4</sub> "H	173	1,916.00
HLT363	36"W, 3 Drawer Lateral File	36"W x 18 <sup>5</sup> / <sub>8</sub> "D x 40 <sup>1</sup> / <sub>4</sub> "H	153	1,782.00
HLT303	30"W, 3 Drawer Lateral File	30"W x 18 <sup>5</sup> / <sub>8</sub> "D x 40 <sup>1</sup> / <sub>4</sub> "H	133	1,626.00
<b>2 Drawer Lateral Files</b>				
HLT422	42"W, 2 Drawer Lateral File	42"W x 18 <sup>5</sup> / <sub>8</sub> "D x 28"H	144	1,719.00
HLT362	36"W, 2 Drawer Lateral File	36"W x 18 <sup>5</sup> / <sub>8</sub> "D x 28"H	123	1,471.00
HLT302	30"W, 2 Drawer Lateral File	30"W x 18 <sup>5</sup> / <sub>8</sub> "D x 28"H	101	1,231.00
<b>Optional Accessories</b>				
HLTFBR4	Front-to-Back Filing rails (4 pk.)	1 <sup>3</sup> / <sub>16</sub> "W x 15 <sup>3</sup> / <sub>4</sub> "D x 3 <sup>3</sup> / <sub>4</sub> "H	2.5	88.00
HLTDV10	Divider kit (10 pk.)	5 <sup>1</sup> / <sub>2</sub> "W x 13 <sup>1</sup> / <sub>2</sub> "D x 1"H	8.5	148.00
HMKEY	Master Key	-	-	18.00

Lateral Files on Kwik-Track

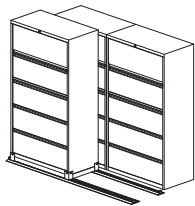

- To increase filing density, lateral files can also mount to Kwik-Track. In either configuration, the rear row of cabinets are stationary with cabinets in front mounted on a sliding carriage on a track mounted to the floor.
- Track and carriage adds 2<sup>3</sup>/<sub>4</sub>" to height of overall system

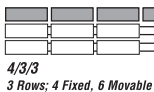
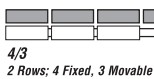
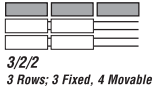
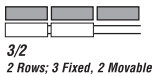
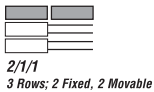
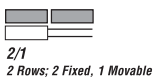

Model No.	Description	Dimensions	Wt.	List Price
<b>36"W 5 Drawer Lateral Files on Kwik-Track</b>				
LATH36521	2/1 Lateral 36"L/5 Drawer System	78"W x 40"D	651	11,195.00
LATH365211	2/1/1 Lateral 36"L/5 Drawer System	78"W x 61 <sup>1</sup> / <sub>2</sub> "D	888	16,477.00
LATH36532	3/2 Lateral 36"L/5 Drawer System	116"W x 40"D	1,087	17,910.00
LATH365322	3/2/2 Lateral 36"L/5 Drawer System	116"W x 61 <sup>1</sup> / <sub>2</sub> "D	1,568	28,460.00
LATH36543	4/3 Lateral 36"L/5 Drawer System	156"W x 40"D	1,521	26,507.00
LATH365433	4/3/3 Lateral 36"L/5 Drawer System	156"W x 61 <sup>1</sup> / <sub>2</sub> "D	2,234	41,191.00
<b>42"W 5 Drawer Lateral Files on Kwik-Track</b>				
LATH42521	2/1 Lateral 42"L/5 Drawer System	90"W x 40"D	740	12,047.00
LATH425211	2/1/1 Lateral 42"L/5 Drawer System	90"W x 61 <sup>1</sup> / <sub>2</sub> "D	1,020	17,405.00
LATH42532	3/2 Lateral 42"L/5 Drawer System	137"W x 40"D	1,238	20,224.00
LATH425322	3/2/2 Lateral 42"L/5 Drawer System	137"W x 61 <sup>1</sup> / <sub>2</sub> "D	1,768	30,322.00
LATH42543	4/3 Lateral 42"L/5 Drawer System	180"W x 40"D	1,728	28,496.00
LATH425433	4/3/3 Lateral 42"L/5 Drawer System	180"W x 61 <sup>1</sup> / <sub>2</sub> "D	2,536	43,434.00

Office Suites  
Seating  
Tables & Desks  
Meeting Essentials  
Personal Organization  
Ergonomics  
High Density Storage  
Storage & Filing  
Facilities  
Technology Furniture  
Art & Engineering  
Education  
K-12  
SAFE Collection Addendum

# Resi® Storage - Free Standing Lockers



Safco® Products marketing materials are designed to be used as sales tools for our Dealer network.

- 36" lockers available with two 18" doors with internal dividing shelf
- Keyed (random – master key available) or Digital Locks (revolving code)
- Individual locker modules ship fully assembled
- Concealed adjustable door hinges
- Work surfaces are constructed with 1 1/2" particle board with HPL and 3mm PVC edge banding
- All steel is finished with powder coat paint (white or textured black)
- 4 leveling glides for easy alignment (per locker)
- Upholstered seat cushions for use with CC01 only, available in grade 1-3 and COM
- Ganging hardware included for front to back, side to side, and top to bottom connection
- Optional toe-kick for use with CCL18C & CCL36C

Model #	Description	Fabric Grades/ Model #	List Price Ea.	List Carton Price	Quantity Per Carton	Actual Weight	S-Parcel Billable Weight	Carton Cube	Freight Class
<b>Resi® Storage - Free Standing Lockers</b>									
CC01	Resi® Storage - Single Wide Bench* Locker Height: 18 1/2" Locker Upholstered Seat Height: 21 1/2" Seat Size: 60"W x 18"D Overall Size: 60"W x 18"D x 18 1/2"H (21 1/2"H with Locker Upholstery)	CC01	2,651.00	2,651.00	-	-	LTL	-	-
	<b>Door Material</b> Steel			Upcharge N/C					
	<b>Lock Type</b> Keyed Lock Digital Lock - DL (Price is Per Lock)			Upcharge N/C					
	<b>Metal Color</b> White Powder Coat Black Textured Powder Coat			N/C					
CCUC	<b>Locker Upholstery*</b> (Adds 3" to Seat Height, 4 Cushions per carton) Grade 1 Grade 2 Grade 3 COM Yardage: 2 yds.	01 02 03 COM		Upcharge N/C	4				See pgs. 52-53 for Grades 01 - 03 fabric swatches

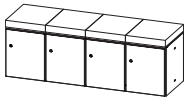

\*Must order the Locker Upholstery separate when Ordering the CC01

EXAMPLE OF HOW TO ORDER LOCKER UPHOLSTERY:

Model	Fabric Grade	Fabric Color	See pgs. 52-53 for Grades 01 - 03 fabric swatches
C C U C +	0 2 +	V I 0 1	

CC06	Resi® Storage - Locker Wall Straight Overall Size: 62 1/2"W x 18 1/2"D x 77 1/2"H	CC06	9,016.00	9,016.00	-	-	LTL	-	-
	<b>Number of Doors for 36" Lockers</b> Double Door - DD			N/C					
	<b>Door Material</b> Steel			Upcharge N/C					
	<b>Lock Type</b> Keyed Lock Digital Lock - DL (Price is Per Lock)			Upcharge N/C					
	<b>Metal Color</b> White Powder Coat Black Textured Powder Coat			N/C					

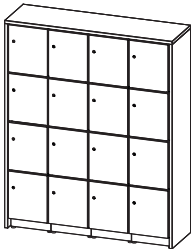

PLEASE CHOOSE OPTIONS FROM BELOW:

Model	Number of Doors for 36" Lockers	Door Material	Lock Type	Metal Frame Color	High Pressure Laminate (HPL) Worksurface Color	Edge Band Worksurface Color
CC06	DD-Double Door	STE-Steel	KL-Keyed Lock DL-Digital Lock	WH-White BL-Black Textured	DSWT-Designer White CLWN-Columbian Walnut BLAK-Black FNGY-Fashion Gray FUMP-Fusion Maple AISA-Asian Sand	BK-Black DB-Dark Brown WI-Designer White IG-Ice Gray
<b>Example:</b>						
C C 0 6 +	D D +	S T E +	D L +	B L +	D S W T +	I G

Office Suites  
Seating  
Tables & Desks  
Meeting Essentials  
Personal Organization  
Ergonomics  
High Density Storage  
Storage & Filing  
Facilities  
Technology Furniture  
Art & Engineering  
K-12 Education  
SAFE Collection Addendum

## Resi® Storage - A-Frame Workstation Lockers

Model #	Description	Fabric Grades/ Model #	List Price Ea.	List Carton Price	Quantity Per Carton	Actual Weight	S-Parcel Billable Weight	Carton Cube	Freight Class
	<b>CC08</b> Resi® Storage - A-Frame Bistro/Counter w/Riser (Long) Counter Size: 75"W x 37"D Locker Surface Height: 37 3/4"H Overall Size: 105"W x 37"D x 41 1/2"H <b>Number of Doors for 36" Lockers</b> Double Door - DD	CC08	8,761.00	8,761.00	-	-	LTL	-	-
	<b>Door Material</b> Steel		N/C	N/C					
	<b>Lock Type</b> Keyed Lock Digital Lock - DL (Price is Per Lock)		N/C 106.00	N/C 106.00					
	<b>Metal Frame Color</b> White Powder Coat Black Textured Powder Coat		N/C N/C	N/C N/C					
	<b>Upcharge</b>								
	<b>Upcharge</b>								
	<b>CC10</b> Resi® Storage - A-Frame Bistro/Counter w/o Riser (Long) Counter Size: 105"W x 37"D Overall Size: 105"W x 37"D x 41 1/2"H <b>Number of Doors for 36" Lockers</b> Double Door - DD	CC10	8,680.00	8,680.00	-	-	LTL	-	-
	<b>Door Material</b> Steel		N/C	N/C					
	<b>Lock Type</b> Keyed Lock Digital Lock - DL (Price is Per Lock)		N/C 106.00	N/C 106.00					
	<b>Metal Frame Color</b> White Powder Coat Black Textured Powder Coat		N/C N/C	N/C N/C					
	<b>Upcharge</b>								
	<b>Upcharge</b>								
	<b>CC11</b> Resi® Storage - A-Frame Bistro/Counter w/o Riser (Short) Counter Size: 75"W x 37"D Overall Size: 75"W x 37"D x 41 1/2"H <b>Number of Doors for 36" Lockers</b> Double Door - DD	CC11	7,710.00	7,710.00	-	-	LTL	-	-
	<b>Door Material</b> Steel		N/C	N/C					
	<b>Lock Type</b> Keyed Lock Digital Lock - DL (Price is Per Lock)		N/C 106.00	N/C 106.00					
	<b>Metal Frame Color</b> White Powder Coat Black Textured Powder Coat		N/C N/C	N/C N/C					
	<b>Upcharge</b>								
	<b>Upcharge</b>								

## Resi® Storage - Stand-Alone Locker Options

Resi™ Storage - Stand-Alone Locker Options									
	<b>CCL18C</b> Resi® Storage - 18" Single Locker Overall Size: 15"W x 18"D x 18 1/2"H <b>Door Material</b> Steel	CCL18C	506.00	506.00	-	-	LTL	-	-
	<b>Lock Type</b> Keyed Lock Digital Lock - DL (Price is Per Lock)		N/C 106.00	N/C 106.00					
	<b>Metal Color</b> White Powder Coat Black Textured Powder Coat		N/C N/C	N/C N/C					
	<b>Upcharge</b>								
	<b>Upcharge</b>								
	<b>CCL36C</b> Resi® Storage - 36" Single Locker with internal shelf between doors Overall Size: 15"W x 18"D x 36 1/2"H <b>Number of Doors for 36" Lockers</b> Double Door - DD	CCL36C	942.00	942.00	-	-	LTL	-	-
	<b>Door Material</b> Steel		N/C	N/C					
	<b>Lock Type</b> Keyed Lock Digital Lock - DL (Price is Per Lock)		N/C 106.00	N/C 106.00					
	<b>Metal Color</b> White Powder Coat Black Textured Powder Coat		N/C N/C	N/C N/C					
	<b>Upcharge</b>								
	<b>CCTK</b> Resi® Storage - Toe-Kick Option for CCL18C & CCL36C Overall Size: 15"W x 15"D x 3 3/4"H Finish: Black Textured-BL, White-WH	CCTKBL CCTKWH	76.00	76.00	-	-	LTL	-	-
	<b>Replacement Keys</b>								
	Replacement Key 201-300*		39.00	39.00	1	1	1	-	110
	920000462 Master Key		39.00	39.00	1	1	1	-	110

\* When requesting a replacement key the lock/key number, located on the face of the lock, is required







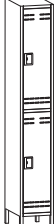

**PROP 65** These products are subject to California Proposition 65. Please visit the product detail page on our website for specific information.

Office Suites  
Seating  
Tables & Desks  
Meeting Essentials  
Personal Organization  
Ergonomics  
High Density Storage  
Storage & Filing  
Facilities  
Technology Furniture  
Art & Engineering  
K-12 Education  
SAFE Collection Addendum

# Steel Lockers

Safco® Products marketing materials are designed to be used as sales tools for our Dealer network.

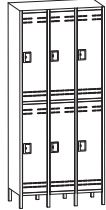
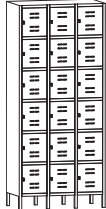
Office Suites  
Seating  
Tables & Desks  
Meeting Essentials  
Personal Organization  
Ergonomics  
High Density Storage  
Storage & Filing  
Facilities  
Technology Furniture  
Art & Engineering  
K-12 Education  
SAFE Collection Addendum

Model #	Description	Model #	List Price Ea.	List Carton Price	Quantity Per Carton	Actual Weight	S-Parcel Billable Weight	Carton Cube	Freight Class
<b>Steel Lockers - Single Tier</b>									
 5522	Single Tier Locker 12"W x 18"D x 78"H Finish: Gray-GR, Tan-TN	5522GR 5522TN	607.00	607.00	1	70	LTL	11.84	250
 5523	Double Tier Locker 12"W x 18"D x 78"H Finish: Gray-GR, Tan-TN	5523GR 5523TN	639.00	639.00	1	71	LTL	11.63	125
 5524	Six Tier Locker 12"W x 18"D x 78"H Finish: Gray-GR, Tan-TN	5524GR 5524TN	676.00	676.00	1	78	LTL	12.48	125
 5528	Ten Tier Locker 12"W x 18"D x 78"H Finish: Gray-GR, Tan-TN	5528GR 5528TN	853.00	853.00	1	71	LTL	11.84	125
 5516	Single Sloped Metal Locker Hood Addition 12"W x 18"D x 6"H	5516GR 5516TN	71.00	71.00	1	6.2	6.2	0.48	150
 5519	Single Continuous Metal Locker Base Addition 11 3/4"W x 16"D x 5 3/4"H	5519GR 5519TN	71.00	71.00	1	6.2	6.2	0.45	150
<b>Steel Lockers - 3 Column</b>									
 5525	Single Tier Locker - 3 Column 36"W x 18"D x 78"H Finish: Gray-GR, Tan-TN	5525GR 5525TN	1,423.00	1,423.00	1	177	LTL	32.85	250
 5526	Double Tier Locker - 3 Column 36"W x 18"D x 78"H Finish: Gray-GR, Tan-TN	5526GR 5526TN	1,565.00	1,565.00	1	216	LTL	33.32	125
 5527	Six Tier Locker - 3 Column 36"W x 18"D x 78"H Finish: Gray-GR, Tan-TN	5527GR 5527TN	1,702.00	1,702.00	1	243	LTL	36.94	125
 5529	Ten Tier Locker - 3 Column 36"W x 18"D x 78"H Finish: Gray-GR, Tan-TN	5529GR 5529TN	2,310.00	2,310.00	1	243	LTL	36.94	125
 5518	Triple Sloped Metal Locker Hood Addition 36"W x 18"D x 6"H	5518GR 5518TN	141.00	141.00	1	13.7	13.7	1.36	150
 5520	Triple Continuous Metal Locker Base Addition 35"W x 16"D x 5 3/4"H	5520GR 5520TN	141.00	141.00	1	13.7	13.7	1.25	150

# Steel Storage Cabinets









Model #	Description	Model #	List Price Ea.	List Carton Price	Quantity Per Carton	Actual Weight	S-Parcel Billable Weight	Carton Cube	Freight Class
<b>5532</b>	<b>Steel Storage Cabinet - 72"H</b> 30"W x 18"D x 72"H <b>Finish: Gray-GR</b>	5532GR	1,450.00	1,450.00	1	139	LTL	27.26	250

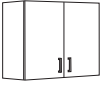

- Office Suites
- Seating
- Tables & Desks
- Meeting Essentials
- Personal Organization
- Ergonomics
- High Density Storage
- Storage & Filing**
- Facilities
- Technology Furniture
- Art & Engineering
- K-12 Education
- SAFE Collection Addendum



















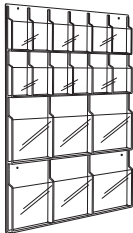

# Hospitality Cabinets

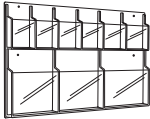
Safco® Products marketing materials are designed to be used as sales tools for our Dealer network.

Model #	Description	Model #	List Price Ea.	List Carton Price	Quantity Per Carton	Actual Weight	S-Parcel Billable Weight	Carton Cube	Freight Class	
<b>Hospitality Cabinets</b>										
 <b>1700</b>	Hospitality Wall Cabinet Overall: 36"W x 15"D x 30"H <b>Finish:</b> Asian Night/Black-AN, Mahogany/Rustic Slate-MH	1700AN 1700MH	897.00	897.00	1	86	LTL	3.91	65	
 <b>1701</b>	Hospitality 2 Door/1 Drawer Base Cabinet Countertop: 36"H, Overall: 36"W x 25"D x 39"H <b>Finish:</b> Asian Night/Black-AN, Mahogany/Rustic Slate-MH	1701AN 1701MH	1,744.00	1,744.00	1	152	LTL	5.97	65	
 <b>1702</b>	Hospitality 2 Door Base Cabinet Countertop: 36"H, Overall: 36"W x 25"D x 39"H <b>Finish:</b> Asian Night/Black-AN, Mahogany/Rustic Slate-MH	1702AN 1702MH	1,631.00	1,631.00	1	154	LTL	5.97	65	
 <b>1703</b>	Hospitality 3 Drawer Base Cabinet Countertop: 36"H, Overall: 36"W x 25"D x 39"H <b>Finish:</b> Asian Night/Black-AN, Mahogany/Rustic Slate-MH	1703AN 1703MH	2,025.00	2,025.00	1	182	LTL	5.97	65	
 <b>1704</b>	Hospitality Waste Management Base Cabinet Countertop: 36"H, Overall: 36"W x 25"D x 39"H <b>Finish:</b> Asian Night/Black-AN, Mahogany/Rustic Slate-MH	1704AN 1704MH	1,531.00	1,531.00	1	121	LTL	4.7	65	
 <b>9669</b>	Rectangular Rigid Plastic Liner 36 Gallon Capacity	9669	228.00	228.00	1	11	49	4.53	250	
 <b>1705</b>	Hospitality Appliance Base Cabinet Countertop: 36"H, Overall: 36"W x 25"D x 39"H <b>Finish:</b> Asian Night/Black-AN, Mahogany/Rustic Slate-MH	1705AN 1705MH	1,770.00	1,770.00	1	138	LTL	5.06	65	
 <b>1706</b>	Hospitality Appliance Hutch Cabinet Overall: 36"W x 18"D x 48"H <b>Finish:</b> Asian Night/Black-AN, Mahogany/Rustic Slate-MH	1706AN 1706MH	896.00	896.00	1	90	LTL	4.54	65	

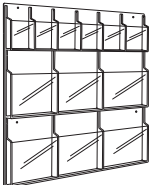
# Luxe™ Literature Displays

 <b>4134SL</b>	Luxe™ 9 Pocket Display 9 Magazine or 18 Pamphlet 31¾"W x 5"D x 41"H <b>Finish:</b> Silver-SL	4134SL	456.00	456.00	1	15	24	2.0	125
---	---	--------	--------	--------	---	----	----	-----	-----





Model #	Description	Model #	List Price Ea.	List Carton Price	Quantity Per Carton	Actual Weight	S-Parcel Billable Weight	Carton Cube	Freight Class
<b>Reveal™ Literature Displays</b>									
	<b>5602CL</b> Reveal™ Display - 12 Magazine 30"W x 2"D x 49"H Finish: Clear-CL   	5602CL	579.00	579.00	1	13	42	3.96	250
	<b>5603CL</b> Reveal™ Display - 9 Magazine 30"W x 2"D x 36¾"H Finish: Clear-CL   	5603CL	517.00	517.00	1	12	32	3.06	250
	<b>5600CL</b> Reveal™ Display - 6 Magazine/12 Pamphlet 30"W x 2"D x 45"H Finish: Clear-CL   	5600CL	553.00	553.00	1	12	39	3.7	250
	<b>5605CL</b> Reveal™ Display - 3 Magazine/6 Pamphlet 30"W x 2"D x 22½"H Finish: Clear-CL   	5605CL	390.00	390.00	1	6	21	1.84	250
	<b>5606CL</b> Reveal™ Display - 6 Pamphlet/6 Magazine 30"W x 2"D x 34¾"H Finish: Clear-CL   	5606CL	513.00	513.00	1	9	31	2.7	250

Office Suites  
Seating  
Tables & Desks  
Meeting Essentials  
Personal Organization  
Ergonomics  
High Density Storage  
Storage & Filing  
Facilities  
Technology Furniture  
Art & Engineering  
K-12 Education  
SAFE Collection Addendum

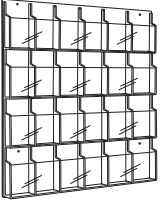

# Reveal™ Literature Displays

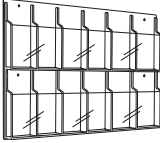







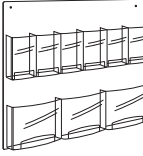

Safco® Products marketing materials are designed to be used as sales tools for our Dealer network.

Model #	Description	Model #	List Price Ea.	List Carton Price	Quantity Per Carton	Actual Weight	S-Parcel Billable Weight	Carton Cube	Freight Class
<b>Reveal™ Literature Displays</b>									
 5601CL	Reveal™ Display - 24 Pamphlet 30"W x 2"D x 41"H Finish: Clear-CL	5601CL	546.00	546.00	1	10	35	3.52	250
 									
 5604CL	Reveal™ Display - 12 Pamphlet 30"W x 2"D x 20 1/4"H Finish: Clear-CL	5604CL	349.00	349.00	1	5	20	1.83	250
 									

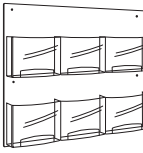
# Reveal™ Tabletop Displays

<b>Reveal™ Tabletop Displays</b>									
 5698CL	Reveal™ Tabletop Display, Triangle - 6 Magazine 15"W x 15"D x 14"H Finish: Clear-CL	5698CL	285.00	285.00	1	11	30	2.72	150
 									

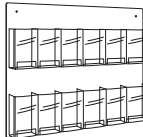
Office Suites  
Seating  
Tables & Desks  
Meeting Essentials  
Personal Organization  
Ergonomics  
High Density Storage  
Storage & Filing  
Facilities  
Technology Furniture  
Art & Engineering  
K-12 Education  
SAFE Collection Addendum



Model #	Description	Model #	List Price Ea.	List Carton Price	Quantity Per Carton	Actual Weight	S-Parcel Billable Weight	Carton Cube	Freight Class
<b>Clear2c™ Literature Displays</b>									
	<b>5665CL</b> Clear2c™ Display - 9 Magazine 29"W x 3"D x 36"H Finish: Clear-CL	5665CL	419.00	419.00	1	15	30	2.59	150
									
	<b>5666CL</b> Clear2c™ Display - 3 Magazine/6 Pamphlet 29"W x 3"D x 23½"H Finish: Clear-CL	5666CL	319.00	319.00	1	10	21	1.91	150
									
	<b>5667CL</b> Clear2c™ Display - 6 Magazine 28¾"W x 3"D x 23½"H Finish: Clear-CL	5667CL	286.00	286.00	1	9	21	1.94	150
									
	<b>5668CL</b> Clear2c™ Display - 6 Magazine/6 Pamphlet 29"W x 3"D x 36"H Finish: Clear-CL	5668CL	428.00	428.00	1	14	30	2.59	150
									
	<b>5671CL</b> Clear2c™ Display - 12 Pamphlet 28¾"W x 3"D x 23½"H Finish: Clear-CL	5671CL	305.00	305.00	1	9	21	1.93	150
									

# Wood Literature Displays

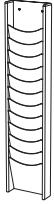
Safco® Products marketing materials are designed to be used as sales tools for our Dealer network.

Model #	Description	Model #	List Price Ea.*	List Carton Price	Quantity Per Carton	Actual Weight	S-Parcel Billable Weight	Carton Cube	Freight Class
	<b>Wood Literature Displays</b> 4331 Wood Magazine Rack - 12 Pocket 11¼"W x 3¾"D x 48¾"H Finish: Medium Oak-MO	4331MO	371.00	371.00	1	17	20	1.81	100

# Literature Displays

Model #	Description	Model #	List Price Ea.*	List Carton Price	Quantity Per Carton	Actual Weight	S-Parcel Billable Weight	Carton Cube	Freight Class
	<b>Steel Literature Displays</b> 4128CH Rotary Brochure Rack 32 Compartments 15"W x 15"D x 60"H Finish: Charcoal-CH	4128CH	490.00	490.00	1	20	42	3.89	150
	4139CH Rotary Literature Rack 16 Compartments 15"W x 15"D x 60"H Finish: Charcoal-CH	4139CH	482.00	482.00	1	17	36	3.39	150





# Onyx™ Mesh Display Racks

	5580BL Onyx™ Rotating Magazine Stand - 16 Pocket 18¼"W x 18¼"D x 58¾"H Finish: Black-BL	5580BL	616.00	616.00	1	48.4	106	9.64	85
---	---	--------	--------	--------	---	------	-----	------	----



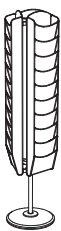

These products are subject to California Proposition 65. Please visit the product detail page on our website for specific information.

Office Suites  
Seating  
Tables & Desks  
Meeting Essentials  
Personal Organization  
Ergonomics  
High Density Storage  
Storage & Filing  
Facilities  
Technology Furniture  
Art & Engineering  
K-12 Education  
SAFE Collection Addendum

Model #	Description	Model #	List Price Ea.	List Carton Price	Quantity Per Carton	Actual Weight	S-Parcel Billable Weight	Carton Cube	Freight Class	
<b>Onyx™ Mesh Magazine Racks</b>										
	<b>5577BL</b> Onyx™ Rotating Mesh Magazine Display - 30 Pocket 16½" Dia. x 66"H Finish: Black-BL	5577BL	603.00	603.00	1	44	70	6.59	85	
	<b>5578BL</b> Onyx™ Mesh Wall Mount Magazine Rack - 5 Pocket 10¼"W x 3½"D x 28½"H Finish: Black-BL	5578BL	140.00	140.00	1	6	12	1.06	150	
	<b>5579BL</b> Onyx™ Mesh Wall Mount Magazine Rack - 10 Pocket 10¼"W x 3½"D x 50½"H Finish: Black-BL	5579BL	208.00	208.00	1	10	21	1.86	150	
<b>Onyx™ Mesh Floor Rack</b>										
	<b>6461BL</b> Onyx™ Mesh Floor Rack - 5 Pocket Pocket Size: 12¼"W x 2¼"D x 8½"H Overall: 12½"W x 18½"D x 46"H Finish: Black-BL	6461BL	152.00	152.00	1	13	22	1.84	250	

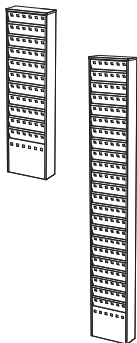



Literature Displays - Steel

<b>Steel Magazine &amp; Brochure Racks</b>										
	<b>4321</b> Steel Magazine Rack - 11 Pocket 10"W x 4"D x 36¼"H Finish: Black-BL, Gray-GR	4321BL 4321GR	238.00	238.00	1	13	14	1.33	250	
	<b>4322</b> Steel Magazine Rack - 23 Pocket 10"W x 4"D x 65½"H Finish: Black-BL, Gray-GR	4322BL 4322GR	344.00	344.00	1	24	28	2.45	250	
	<b>4323</b> Base for Steel Magazine Racks 10"W x 14"D x 5¼"H Finish: Black-BL, Gray-GR	4323BL 4323GR	63.00	63.00	1	4	6	0.56	250	
	<b>4325</b> Steel Rotary Magazine Rack - 92 Pocket 14"W x 14"D x 68"H Finish: Black-BL	4325BL	1,382.00	1,382.00	1	104	LTL	12.09	250	

Office Suites  
Seating  
Tables & Desks  
Meeting Essentials  
Personal Organization  
Ergonomics  
High Density Storage  
Storage & Filing  
Facilities  
Technology Furniture  
Art & Engineering  
K-12 Education  
SAFE Collection Addendum

# E-Z Stor® Steel Literature Organizers

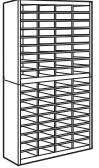

Safco® Products marketing materials are designed to be used as sales tools for our Dealer network.

Model #	Description	Model #	List Price Ea.	List Carton Price	Quantity Per Carton	Actual Weight	S-Parcel Billable Weight	Carton Cube	Freight Class
<b>E-Z Stor® Steel Literature Organizers</b>									
 9211	E-Z Stor® Steel Literature Organizer - 24 Compartment 37½"W x 12¾"D x 25¾"H Finish: Black-BLR, Gray-GRR, Tropic Sand-TSR Can be wall mounted using 9200BL	9211BLR 9211GRR	727.00	727.00	1	58	59	2.56	70
 9221	E-Z Stor® Steel Literature Organizer - 36 Compartment 37½"W x 12¾"D x 36¾"H Finish: Black-BLR, Gray-GRR, Tropic Sand-TSR Can be wall mounted using 9200BL	9221BLR 9221GRR	885.00	885.00	1	80	80	2.56	70
 9231	E-Z Stor® Steel Literature Organizer - 60 Compartment 37½"W x 12¾"D x 60"H Finish: Black-BLR, Gray-GRR, Tropic Sand-TSR	9231BLR 9231GRR	1,406.00	1,406.00	1	139	LTL	6.81	70
 9241	E-Z Stor® Steel Literature Organizer - 72 Compartment 37½"W x 12¾"D x 71"H Finish: Black-BLR, Gray-GRR, Tropic Sand-TSR	9241BLR 9241GRR	1,567.00	1,567.00	1	158	LTL	6.78	70
 9200BL	E-Z Stor® Wall Mounting Brackets 34"W x 4"H Finish: Black-BL	9200BL	125.00	125.00	1	4.8	5	0.11	60



# E-Z Stor® Steel Project Organizers

 9264GR	E-Z Stor® Steel Project Organizer - 18 Compartment 37½"W x 15¾"D x 36¾"H Finish: Gray-GR Can be wall mounted - use 9200BL	9264GR	1,004.00	1,004.00	1	73	74	3.57	70
--	--	--------	----------	----------	---	----	----	------	----

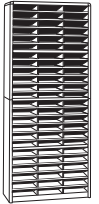

# Value Sorter® Steel Literature Organizers

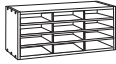
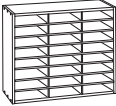
<b>Value Sorter® Steel Literature Organizers</b>									
 7111	Value Sorter® Literature Organizer - 24 Compartment 32¾"W x 13¾"D x 25¾"H Finish: Black-BL, Medium Oak-MO	7111BL 7111MO	372.00	372.00	1	27	27	2.64	70
 7121	Value Sorter® Literature Organizer - 36 Compartment 32¾"W x 13¾"D x 38"H Finish: Black-BL, Medium Oak-MO	7121BL 7121MO	431.00	431.00	1	37	38	3.19	70
 7131	Value Sorter® Literature Organizer - 72 Compartment 32¾"W x 13¾"D x 75"H Finish: Black-BL, Medium Oak-MO	7131BL 7131MO	740.00	740.00	1	67	68	5.03	70





## Wood/Corrugated Literature Organizers

	Model #	Description	Model #	List Price Ea.	List Carton Price	Quantity Per Carton	Actual Weight	S-Parcel Billable Weight	Carton Cube	Freight Class
<b>Wood/Corrugated Literature Organizers</b>										
	9401MO	Wood/Corrugated - 12 Compartment 29"W x 12"D x 12"H Finish: Medium Oak-MO	9401MO	179.00	179.00	1	18	18	0.94	85
	9402MO	Wood/Corrugated - 24 Compartment 29"W x 12"D x 23½"H Finish: Medium Oak-MO	9402MO	213.00	213.00	1	30	30	1.43	70
	9403MO	Wood/Corrugated - 36 Compartment 29"W x 12"D x 34½"H Finish: Medium Oak-MO	9403MO	275.00	275.00	1	33	33	1.87	70

## E-Z Stor® Wood Literature Organizers

	9311	E-Z Stor® Wood Literature Organizer - 24 Compartment 40"W x 11¼"D x 23"H Finish: Cherry-CY, Mahogany-MH	9311CY 9311MH	659.00	659.00	1	67	67	2.48	70
	9321	E-Z Stor® Wood Literature Organizer - 36 Compartment 40"W x 11¼"D x 32½"H Finish: Mahogany-MH	9321MH	795.00	795.00	1	90	90	3.14	70
	9331	E-Z Stor® Literature Organizer - 60 Compartment 40"W x 11¼"D x 52½"H Finish: Mahogany-MH	9331MH	1,319.00	1,319.00	1	132	132	4.58	70

## Wood Adjustable Literature Organizers

	9422	Wood Adjustable Literature Organizer - 16 Compartment 19½"W x 11¼"D x 21"H Finish: Gray-GR, Medium Oak-MO	9422GR 9422MO	217.00	217.00	1	24	24	0.65	85
	9423	Wood Adjustable Literature Organizer - 24 Compartment 39¼"W x 11¼"D x 16¼"H Finish: Gray-GR, Medium Oak-MO	9423GR 9423MO	273.00	273.00	1	41	41	1.24	85
	9424	Wood Adjustable Literature Organizer - 36 Compartment 39¼"W x 11¼"D x 24"H Finish: Gray-GR, Medium Oak-MO	9424GR 9424MO	331.00	331.00	1	52	52	1.62	85
	9494	Wood Adjustable Literature Organizer 32 Compartment/2 Drawer 39¼"W x 11¼"D x 25¼"H Finish: Gray-GR, Medium Oak-MO	9494GR 9494MO	383.00	383.00	1	70	70	1.96	85







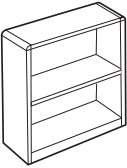
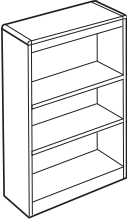
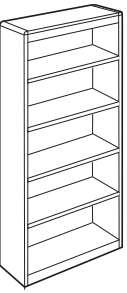
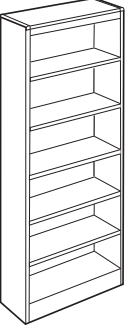

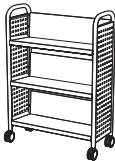

Office Suites  
Seating  
Tables & Desks  
Meeting Essentials  
Personal Organization  
Ergonomics  
High Density Storage  
Storage & Filing  
Facilities  
Technology Furniture  
Art & Engineering  
K-12 Education  
SAFE Collection Addendum

# ValueMate® Steel Bookcases

Safco® Products marketing materials are designed to be used as sales tools for our Dealer network.

Model #	Description	Model #	List Price Ea.	List Carton Price	Quantity Per Carton	Actual Weight	S-Parcel Billable Weight	Carton Cube	Freight Class
ValueMate® Steel Bookcases									
	<b>7170</b> ValueMate® Steel Bookcase - 2 Shelf Weight Capacity: 70 lbs./Shelf Overall Size: 31½"W x 13½"D x 28"H Finish: Black-BL, Gray-GR	7170BL 7170GR	274.00	274.00	1	25	31	2.69	85
	<b>7171</b> ValueMate® Steel Bookcase - 3 Shelf Weight Capacity: 70 lbs./Shelf Overall Size: 31½"W x 13½"D x 41"H Finish: Black-BL, Gray-GR	7171BL 7171GR	321.00	321.00	1	31	32	3.14	85
	<b>7173</b> ValueMate® Steel Bookcase - 5 Shelf Weight Capacity: 70 lbs./Shelf Overall Size: 31½"W x 13½"D x 67"H Finishes: Black-BL, Gray-GR	7173BL 7173GR	508.00	508.00	1	50	50	3.65	85
	<b>7174</b> ValueMate® Steel Bookcase - 6 Shelf Weight Capacity: 70 lbs./Shelf Overall Size: 31½"W x 13½"D x 80"H Finish: Black-BL, Gray-GR	7174BL 7174GR	581.00	581.00	1	55	55	3.62	85

Office Suites  
Seating  
Tables & Desks  
Meeting Essentials  
Personal Organization  
Ergonomics  
High Density Storage  
Storage & Filing  
Facilities  
Technology Furniture  
Art & Engineering  
K-12 Education  
SAFE Collection Addendum

	Model #	Description	Model #	List Price Ea.	List Carton Price	Quantity Per Carton	Actual Weight	S-Parcel Billable Weight	Carton Cube	Freight Class
<b>Mobile Book Carts</b>										
	5333BL	Wire Book Cart 44"W x 18½"D x 40¼"H Finish: Black-BL	5333BL	419.00	419.00	1	38	39	2.18	70
	5335BL	Scoot™ Book Cart - Double-Sided - 6 Shelf 41¼"W x 17¼"D x 41"H Finish: Black-BL	5335BL	751.00	751.00	1	73	74	5.23	85
	5336BL	Scoot™ Book Cart - Single-Sided - 3 Shelf 33"W x 14¼"D x 44¼"H Finish: Black-BL	5336BL	606.00	606.00	1	60	60	4.68	85
<b>Steel Mobile Book Carts</b>										
	5357SA	Steel Book Cart - Double-Sided - 6 Shelf 36"W x 18½"D x 43½"H Finish: Sand-SA	5357SA	982.00	982.00	1	72	LTL	17.23	250
	5358SA	Steel Book Cart - Single-Sided - 3 Shelf 36"W x 14¼"D x 43½"H Finish: Sand-SA	5358SA	816.00	816.00	1	52	LTL	13.93	250
						<b>Wire Mobile File Carts</b>				
<b>Wire Mobile File Carts</b>										
	5201	Wire Mobile Cart 14"W x 24"D x 20½"H Finish: Black-BL, Gray-GR	5201BL 5201GR	181.00	181.00	1	13	13	0.77	70
	5277BL	Compact Mobile File Cart 15½"W x 14"D x 19¼"H Finish: Black-BL	5277BL	168.00	168.00	1	8	9	0.49	70
	5278BL	Two Tier Rolling File Cart 25¼"W x 14"D x 29¼"H Finish: Black-BL	5278BL	298.00	298.00	1	20	20	1.49	70
						<b>Wire Utility Carts</b>				
<b>Wire Utility Carts</b>										
	5337BL	Wire Utility Cart - 2 Shelf Weight Capacity: 200 lbs./Shelf 43¾"W x 19"D x 40¼"H Finish: Black-BL	5337BL	316.00	316.00	1	29	29	81.46	70
	5338BL	Wire Utility Cart - 3 Shelf Weight Capacity: 200 lbs./Shelf 43¾"W x 19"D x 40¼"H Finish: Black-BL	5338BL	385.00	385.00	1	37	37	2.25	70
						<b>Scoot™ Steel Utility Cart</b>				
<b>Scoot™ Steel Utility Cart</b>										
	5339BL	Scoot™ Steel Utility Cart - 3 Shelf Weight Capacity: 100 lbs./Shelf 31"W x 18"D x 38"H Finish: Black-BL	5339BL	679.00	679.00	1	50	50	3.91	85

Office Suites  
Seating  
Tables & Desks  
Meeting Essentials  
Personal Organization  
Ergonomics  
High Density Storage  
Storage & Filing  
Facilities  
Technology Furniture  
Art & Engineering  
K-12 Education  
SAFE Collection Addendum



# Mobile Carts

Safco® Products marketing materials are designed to be used as sales tools for our Dealer network.

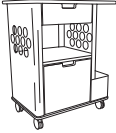
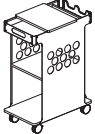
Model #	Description	Model #	List Price Ea.	List Carton Price	Quantity Per Carton	Actual Weight	S-Parcel Billable Weight	Carton Cube	Freight Class
 <b>5390</b>	Go Cart™ Organizer - 8 Compartment 21½"W x 14½"D x 26½"H <b>Finish:</b> Black-BL, Gray-GR	5390BL 5390GR	427.00	427.00	1	40	40	2.79	100
 <b>5202WH</b>	Rolling Storage Cart Overall Size: 28"W x 20"D x 33½"H Work Surface: 28"W x 20"D Slide-Out Drawers: 15½"W x 15¼"D x 5"H 15½"W x 15¼"D x 13¾"H Side Compartment: 5½"W x 17"D x 7"H <b>Finish:</b> Silver Frame with White Top-WH	5202WH	989.00	989.00	1	98.20	103	9.88	70
 <b>5209WH</b>	Mini Rolling Storage Cart Overall Size: 15"W x 25¼"D x 34½"H <b>Finish:</b> Silver Frame with Natural Top-WH	5209WH	548.00	548.00	1	45	46	2.82	100

# Mesh Mobile File Carts

 <b>5350BL</b>	Mesh Tub File with Open Top 13½"W x 24¼"D x 27½"H <b>Finish:</b> Black-BL	5350BL	442.00	442.00	1	21	21	1.13	70
---	---	--------	--------	--------	---	----	----	------	----

# Steel Tub Files

 <b>5361</b>	Standard Steel Tub File, Letter with Lock 13½"W x 19"D x 28"H <b>Finish:</b> Black-BL	5361BL	407.00	407.00	1	27	62	5.95	250
 <b>5362</b>	Extra Deep Steel Tub File, Letter with Lock 13½"W x 24¼"D x 28¼"H <b>Finish:</b> Black-BL	5362BL	419.00	419.00	1	33	73	6.81	250
 <b>5363</b>	Extra Deep Steel Tub File, Legal with Lock 16"W x 24¼"D x 28¼"H <b>Finish:</b> Black-BL	5363BL	619.00	619.00	1	37	87	7.98	250
 <b>5364</b>	Steel Tub File, Letter with Drawer & Lock 17"W x 26"D x 28"H <b>Finish:</b> Black-BL	5364BL	945.00	945.00	1	59	LTL	8.35	125





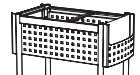

Office Suites  
Seating  
Tables & Desks  
Meeting Essentials  
Personal Organization  
Ergonomics  
High Density Storage  
Storage & Filing  
Facilities  
Technology Furniture  
Art & Engineering  
K-12 Education  
SAFE Collection Addendum

	Model #	Description	Model #	List Price Ea.	List Carton Price	Quantity Per Carton	Actual Weight	S-Parcel Billable Weight	Carton Cube	Freight Class	
	<b>Scoot™ Mobile Carts</b>										
	5370BL	Scoot™ Cart with Work Surface 29¾"W x 18¾"D x 27"H Finish: Black-BL	5370BL	630.00	630.00	1	44	44	2.81	100	
	5373BL	Scoot™ Open Top Cart 28"W x 14¾"D x 26"H Finish: Black-BL	5373BL	448.00	448.00	1	29	29	2.09	100	

**Steel Mobile File Cart**

	<b>Steel Mobile File Cart</b>										
	5353BL	Steel Mobile File with Locking Top 33¾"W x 17"D x 27"H Finish: Black-BL	5353BL	728.00	728.00	1	45	45	2.64	70	





**Onyx™ Mesh Mobile File Carts**

	5211BL	Onyx™ Mesh Rolling File Cube, Letter 13¾"W x 16¾"D x 13"H Finish: Black-BL	5211BL	107.00	107.00	1	7	10	0.8	100
	5212BL	Onyx™ Mesh File Cart with 2 File Drawers 15¾"W x 17"D x 27"H Finish: Black-BL	5212BL	228.00	228.00	1	17	19	1.75	100
	5213BL	Onyx™ Mesh File Cart with File Drawer & 2 Small Drawers 15¾"W x 17"D x 27"H Finish: Black-BL	5213BL	244.00	244.00	1	21	21	1.87	100
	5214BL	Onyx™ Mesh File Cart with 4 Drawers 15¾"W x 17"D x 27"H Finish: Black-BL	5214BL	267.00	267.00	1	23	23	1.85	100
	5215BL	Onyx™ Mesh Open File with Drawers 15¾"W x 17"D x 27"H Finish: Black-BL	5215BL	234.00	234.00	1	15	19	1.87	100



Office Suites  
Seating  
Tables & Desks  
Meeting Essentials  
Personal Organization  
Ergonomics  
High Density Storage  
Storage & Filing  
Facilities  
Technology Furniture  
Art & Engineering  
K-12 Education  
SAFE Collection Addendum

Office Suites  
Seating  
Tables & Desks  
Meeting Essentials  
Personal Organization  
Ergonomics  
High Density Storage  
Storage & Filing  
Facilities  
Technology Furniture  
Art & Engineering  
K-12 Education  
SAFE Collection Addendum

Model #	Description	Model #	List Price Ea.	List Carton Price	Quantity Per Carton	Actual Weight	S-Parcel Billable Weight	Carton Cube	Freight Class
<b>Reflections by Safco®</b>									
	<b>9871</b> Reflections by Safco® Dome, Open Top 15 Gallon Capacity 6" Dome Top 15" Dia. x 34"H <b>Finish: Chrome/Black</b>	9871	628.00	628.00	1	23	70	6.61	250
	<b>9875</b> Reflections by Safco® Dome, Open Top 15 Gallon Capacity 6" Dome Top 15" Dia. x 34"H <b>Finish: Chrome</b>	9875	855.00	855.00	1	23	70	6.61	250
	<b>9893</b> Reflections by Safco® Push Top Square Receptacle 21 Gallon Capacity Spring-loaded, Self-closing Door 14" x 14" x 37½"H <b>Finish: Black/Chrome</b>	9893	494.00	494.00	1	21	65	6.05	250
	<b>9668</b> Rectangular Rigid Plastic Liner 21 Gallon Capacity	9668	168.00	168.00	1	5	29	2.69	300
	<b>9895</b> Reflections by Safco® Push Top Square Receptacle 36 Gallon Capacity Spring-loaded, Self-closing Door 18" x 18" x 37½"H <b>Finish: Black/Chrome</b>	9895	630.00	630.00	1	32	112	10.09	250
	<b>9669</b> Rectangular Rigid Plastic Liner 36 Gallon Capacity	9669	228.00	228.00	1	11	49	4.53	250
	<b>9695</b> Reflections by Safco® Open Top Receptacle 35 Gallon Capacity Lid with 8½" Opening 18½"Dia. x 29½"H <b>Finish: Chrome</b>	9695	1,033.00	1,033.00	1	22	78	7.29	250

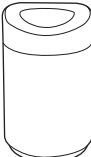
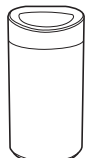

**Open Top Receptacles**

	<b>9920</b> Open Top Receptacle 30 Gallon Capacity 20"Dia. x 33"H <b>Finish: Black-BL, Silver-SL, White-WH</b>	9920BL	709.00	709.00	1	45	96	9.19	150
		9920SL	709.00	709.00	1	45	96	9.19	150
		9920WH	709.00	709.00	1	45	96	9.19	150
	<b>9921</b> Open Top Receptacle 14 Gallon Capacity 16"Dia. x 29"H <b>Finish: Black-BL, Silver-SL, White-WH</b>	9921BL	475.00	475.00	1	28	61	5.81	150
		9921SL	475.00	475.00	1	28	56	5.81	150
		9921WH	475.00	475.00	1	28	56	5.81	150

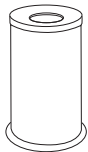
## Black Speckle Waste Receptacles

Model #	Description	Model #	List Price Ea.	List Carton Price	Quantity Per Carton	Actual Weight	S-Parcel Billable Weight	Carton Cube	Freight Class
<b>Black Speckle Open Top Receptacles</b>									
	<b>9677NC</b> Black Speckle Open Top Receptacle 35 Gallon Capacity 8½" Top Opening 19¾" Dia. x 28¾" H	9677NC	651.00	651.00	1	23	87	8.1	250

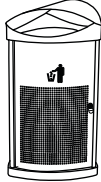

## Nook™ Indoor/Outdoor Waste Receptacles

<b>Nook™ Indoor/Outdoor Waste Receptacle</b>									
	<b>9968BL</b> Nook™ Indoor/Outdoor Waste Receptacle 20 Gallon Capacity 20"W x 20"D x 38"H Finish: Black-BL	9968BL	1,358.00	1,358.00	1	63	131	12.35	250
	<b>9969CH</b> Nook™ Indoor/Outdoor Waste Receptacle 20 Gallon Capacity 20"W x 20"D x 38"H Finish: Black with charcoal resin panels -CH	9969CH	1,385.00	1,385.00	1	81	131	12.35	250





# Step-On Receptacles

Safco® Products marketing materials are designed to be used as sales tools for our Dealer network.



Model #	Description	Model #	List Price Ea.	List Carton Price	Quantity Per Carton	Actual Weight	S-Parcel Billable Weight	Carton Cube	Freight Class
<b>Ellipse Step-On Receptacles</b>									
	<b>9901</b> Ellipse Step-On Receptacle 3 Gallon Capacity 12"W x 8½"D x 17"H <b>Finish:</b> White-WH, Red-RD	9901WH 9901RD	130.00 126.00	130.00 126.00	1 1	7 7	18 18	1.56 1.56	150 150
	<b>9901</b> Step-On Receptacle <b>Finish:</b> Stainless Steel-SS	9901SS	159.00	159.00	1	7	18	1.56	150
	<b>9902</b> Ellipse Step-On Receptacle 7½ Gallon Capacity 15"W x 13½"D x 26½"H <b>Finish:</b> Stainless Steel-SS	9902SS	296.00	296.00	1	14	41	3.71	150
	<b>9903</b> Ellipse Step-On Can 12½ Gallon Capacity 17½"W x 14"D x 26½"H <b>Finish:</b> Stainless Steel-SS	9903SS	480.00	480.00	1	15	57	5.44	250

# Plastic Step-On Receptacles



<b>Plastic Step-On Receptacles</b>									
	<b>9710</b> Plastic Step-On Waste Receptacle 4 Gallon Capacity 12¾"W x 10"D x 15"H <b>Finish:</b> Black-BL, White-WH	9710BL 9710WH	71.00	71.00	1	4	15	1.39	250
	<b>9922</b> Plastic Step-On Waste Receptacle 17 Gallon Capacity 19¾"W x 16¾"D x 26¾"H <b>Finish:</b> Black-BL, Tan-TN	9922BL 9922TN	162.00	162.00	1	12	51	4.65	250
	<b>9923</b> Plastic Step-On Waste Receptacle 23 Gallon Capacity 19¾"W x 16¾"D x 32¾"H <b>Finish:</b> Black-BL, Tan-TN	9923BL 9923TN	198.00	198.00	1	14	62	5.76	250
	<b>9924</b> Plastic Step-On Waste Receptacle 8 Gallon Capacity 15¾"W x 16"D x 17¾"H <b>Finish:</b> Black-BL, Tan-TN	9924BL 9924TN	118.00	118.00	1	5.2	28	2.56	250
	<b>9925</b> Plastic Step-On Waste Receptacle 12 Gallon Capacity 15¾"W x 16"D x 23¾"H <b>Finish:</b> Black-BL, Tan-TN	9925BL 9925TN	143.00	143.00	1	6.4	41	3.62	250
	<b>9926</b> Plastic Step-On Waste Receptacle 32 Gallon Capacity 21¾"W x 20"D x 37"H <b>Finish:</b> Black-BL, Tan-TN	9926BL 9926TN	359.00	359.00	1	22.2	96	8.95	250

Office Suites  
Seating  
Tables & Desks  
Meeting Essentials  
Personal Organization  
Ergonomics  
High Density Storage  
Storage & Filing  
Facilities  
Technology Furniture  
Art & Engineering  
K-12 Education  
SAFE Collection Addendum

## Stainless Step-On Receptacles

Model #	Description	Model #	List Price Ea.	List Carton Price	Quantity Per Carton	Actual Weight	S-Parcel Billable Weight	Carton Cube	Freight Class
<b>Stainless Step-On Receptacles</b>									
	<b>9685SS</b> Stainless Step-On Receptacle 4 Gallon Capacity 10½"W x 11½"D x 20"H Finish: Stainless Steel-SS	9685SS	186.00	186.00	1	10	22	1.91	150
	<b>9686SS</b> Stainless Step-On Receptacle 7 Gallon Capacity 14½"W x 14"D x 20"H Finish: Stainless Steel-SS	9686SS	338.00	338.00	1	14	34	3.09	150
	<b>9687SS</b> Stainless Step-On Receptacle 10 Gallon Capacity 14½"W x 14"D x 25½"H Finish: Stainless Steel-SS	9687SS	395.00	395.00	1	20	47	4.23	150

## Dome Top Receptacles

<b>Dome Top Waste Receptacle</b>									
	<b>9636</b> Dome Top with Push Door 15 Gallon Capacity 15" Dia. x 35"H Finish: Black-BL, Putty-PT, White-WH	9636BL	512.00	512.00	1	20	73	6.56	250
	<b>9639</b> Dome Top with Open Top 15 Gallon Capacity 15" Dia. x 34"H Finish: Black-BL, Putty-PT, White-WH	9639BL 9639WH	470.00	470.00	1	25	62	6.04	150



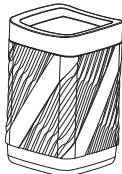

## Twist™ Indoor/Outdoor Waste Receptacles

<b>Twist™ Waste Receptacle</b>									
	<b>9371BL</b> Twist Can Closed Top 32 Gallon Capacity 18½"W x 18½"D x 30"H Finish: Black-BL	9371BL	358.00	358.00	1	19	97	8.91	250
	<b>9372BL</b> Twist Can Open Top 32 Gallon Capacity 18½"W x 18½"D x 30"H Finish: Black-BL	9372BL	323.00	323.00	1	15.6	78	6.93	250

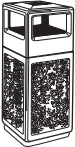
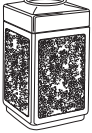

Office Suites  
Seating  
Tables & Desks  
Meeting Essentials  
Personal Organization  
Ergonomics  
High Density Storage  
Storage & Filing  
Facilities  
Technology Furniture  
Art & Engineering  
K-12 Education  
SAFE Collection Addendum

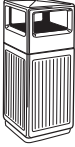
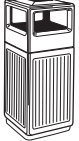
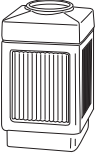
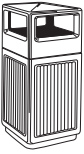
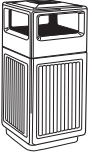
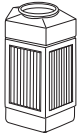
# Canmeleon™ Indoor/Outdoor Series

Safco® Products marketing materials are designed to be used as sales tools for our Dealer network.

Model #	Description	Model #	List Price Ea.	List Carton Price	Quantity Per Carton	Actual Weight	S-Parcel Billable Weight	Carton Cube	Freight Class
<b>Canmeleon™ Aggregate Series Receptacles</b>									
	<b>9470</b> Canmeleon™ Aggregate Panels, Side Open/Urn 15 Gallon Capacity 13 3/4" W x 13 3/4" D x 32 3/4" H <b>Finish:</b> Black-NC	9470NC	868.00	868.00	1	30	54	5.22	150
	<b>9471</b> Canmeleon™ Aggregate Panels, Top Open 38 Gallon Capacity 18 1/4" W x 18 1/4" D x 31 1/4" H <b>Finish:</b> Black-NC	9471NC	903.00	903.00	1	41	91	8.53	150
	<b>9472</b> Canmeleon™ Aggregate Panels, Side Open 38 Gallon Capacity 18 1/4" W x 18 1/4" D x 39 3/4" H <b>Finish:</b> Black-NC, Tan-TN	9472NC 9472TN	1,030.00	1,030.00	1	43	112	10.53	150
	<b>9473</b> Canmeleon™ Aggregate Panels, Side Open/Urn 38 Gallon Capacity 18 1/4" W x 18 1/4" D x 39 3/4" H <b>Finish:</b> Black-NC, Tan-TN	9473NC 9473TN	1,232.00	1,232.00	1	45	112	10.53	150
<b>Canmeleon™ Recessed Panel Series Receptacle</b>									
	<b>9478</b> Canmeleon™ Recessed Panels, Side Open 15 Gallon Capacity 13 3/4" W x 13 3/4" D x 32 3/4" H <b>Finish:</b> Black-BL	9478BL 9478TN	316.00	316.00	1	14	49	4.62	250
	<b>9474</b> Canmeleon™ Recessed Panels, Side Open/Urn 15 Gallon Capacity 13 3/4" W x 13 3/4" D x 32 3/4" H <b>Finish:</b> Black-BL, Tan-TN	9474BL 9474TN	393.00	393.00	1	14	49	4.62	250
	<b>9475</b> Canmeleon™ Recessed Panels, Top Open 38 Gallon Capacity 18 1/4" W x 18 1/4" D x 31 1/4" H <b>Finish:</b> Black-BL	9475BL	376.00	376.00	1	18	74	7.34	250
	<b>9476</b> Canmeleon™ Recessed Panels, Side Open 38 Gallon Capacity 18 1/4" W x 18 1/4" D x 39 3/4" H <b>Finish:</b> Black-BL, Tan-TN	9476BL 9476TN	522.00	522.00	1	21	94	9.0	250
	<b>9477</b> Canmeleon™ Recessed Panels, Side Open/Urn 38 Gallon Capacity 18 1/4" W x 18 1/4" D x 39 3/4" H <b>Finish:</b> Black-BL	9477BL	710.00	710.00	1	23	99	9.11	250
<b>Canmeleon™ Pentagon Indoor/Outdoor Series Receptacles</b>									
	<b>9485BL</b> Canmeleon™ Pentagon 30 Gallon Capacity 18" W x 18 1/2" D x 28 3/4" H <b>Finish:</b> Black-BL	9485BL	328.00	328.00	1	15	78	6.93	250
	<b>9486BL</b> Canmeleon™ Pentagon 45 Gallon Capacity 24" W x 23" D x 31 1/2" H <b>Finish:</b> Black-BL	9486BL	418.00	418.00	1	24	127	12.1	300

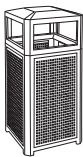
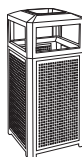
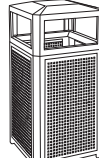
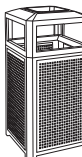
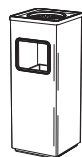
Office Suites  
Seating  
Tables & Desks  
Meeting Essentials  
Personal Organization  
Ergonomics  
High Density Storage  
Storage & Filing  
Facilities  
Technology Furniture  
Art & Engineering  
K-12 Education  
SAFE Collection Addendum

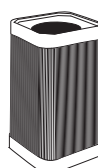
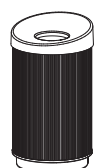
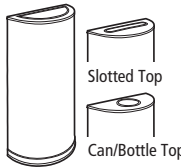
Model #	Description	Model #	List Price Ea.*	List Carton Price	Quantity Per Carton	Actual Weight	S-Parcel Billable Weight	Carton Cube	Freight Class
<b>Evos™ Series Indoor/Outdoor Steel Receptacles</b>									
	<b>9932BL</b> Evos™ Steel Perforated Panels, Side Open 15 Gallon Capacity 16"W x 16"D x 33¼"H <b>Finish:</b> Black-BL	9932BL	966.00	966.00	1	42	83	7.43	150
	<b>9933BL</b> Evos™ Steel Perforated Panels, Side Open/Urn 15 Gallon Capacity 16"W x 16"D x 33¼"H <b>Finish:</b> Black-BL	9933BL	1,088.00	1,088.00	1	42	81	7.38	150
	<b>9934BL</b> Evos™ Steel Perforated Panels, Side Open 38 Gallon Capacity 21"W x 21"D x 41"H <b>Finish:</b> Black-BL	9934BL	1,297.00	1,297.00	1	68	157	14.46	150
	<b>9935BL</b> Evos™ Steel Perforated Panels, Side Open/Urn 38 Gallon Capacity <b>Finish:</b> Black-BL	9935BL	1,427.00	1,427.00	1	68	157	14.46	150
<b>Smoker Receptacles</b>									
	<b>9696BL</b> Square Sandless Ash N' Trash Urn 3 Gallon Capacity 9¾"W x 9¾"D x 24¾"H <b>Finish:</b> Black-BL	9696BL	234.00	234.00	1	14	21	1.75	150
	<b>9698BL</b> Ash Urn 10"Dia. x 20"H <b>Finish:</b> Black-BL	9698BL	133.00	133.00	1	7	17	1.65	150
<b>Waste Receptacles</b>									
	<b>9790BL</b> At-Your-Disposal® Waste Receptacle 38 Gallon Capacity 18"W x 18"D x 32"H <b>Finish:</b> Black-BL	9790BL	207.00	207.00	1	15	37	3.65	150
	<b>9799BL</b> At-Your-Disposal® Vertex Receptacle 38 Gallon Capacity 20"Dia. x 36"H <b>Finish:</b> Black-BL	9799BL	434.00	434.00	1	16	47	4.29	250
<b>Half Round Receptacle</b>									
	<b>9940BL</b> Half Round Receptacle 15 Gallon Capacity 17½"W x 9"D x 32½"H 3 Tops included <b>Finish:</b> Black-BL	9940BL	400.00	400.00	1	10	47	4.28	250

Half-Round Top

Office Suites  
Seating  
Tables & Desks  
Meeting Essentials  
Personal Organization  
Ergonomics  
High Density Storage  
Storage & Filing  
Facilities  
Technology Furniture  
Art & Engineering  
K-12 Education  
SAFE Collection Addendum







# Waste Receptacles

Safco® Products marketing materials are designed to be used as sales tools for our Dealer network.

	Model #	Description	Model #	List Price Ea.*	List Carton Price	Quantity Per Carton	Actual Weight	S-Parcel Billable Weight	Carton Cube	Freight Class	
	<b>Onyx™ Mesh Waste Receptacles</b>										
		<b>9716BL</b> Onyx™ Mesh Small Round Waste Receptacle 3 Quart Capacity 7½" Dia. x 9"H <b>Finish:</b> Black-BL <b>* Only available to order by Carton.</b>	9716BL	23.00	69.00	3	4	8	0.76	150	
		<b>9717BL</b> Onyx™ Mesh Medium Round Waste Receptacle 5 Gallon Capacity 13½" Dia. x 14½"H <b>Finish:</b> Black-BL <b>* Only available to order by Carton.</b>	9717BL	46.00	138.00	3	8	26	2.5	250	
		<b>9718BL</b> Onyx™ Mesh Large Round Waste Receptacle 9 Gallon Capacity 13½" Dia. x 19½"H <b>Finish:</b> Black-BL <b>* Only available to order by Carton.</b>	9718BL	66.00	198.00	3	11	42	3.91	250	
	<b>Bubble Waste Receptacle</b>										
		<b>9740BL</b> Bubble Waste Receptacle 6 Gallon Capacity 11½" Dia. x 12½"H <b>Finish:</b> Black-BL <b>* Only available to order by Carton.</b>	9740BL	63.00	189.00	3	10	24	2.1	250	
	<b>Round Waste Receptacles</b>										
		<b>9604</b> Medium Round Waste Receptacle 23½ Quart Capacity 13" Dia. x 14"H <b>Finish:</b> Black-BL, Charcoal-CH <b>* Only available to order by Carton.</b>	9604BL 9604CH	44.00	264.00	6	26	34	2.9	85	
		<b>9610CH</b> Tall Round Waste Receptacle 80 Quart Capacity 15½" Dia. x 29½"H <b>Finish:</b> Charcoal-CH <b>* Only available to order by Carton.</b>	9610CH	120.00	360.00	3	27	67	6.17	150	
	<b>Rectangular Waste Receptacles</b>										
		<b>9616BL</b> Medium Rectangular Waste Receptacle 27½ Quart Capacity 16½"W x 9"D x 15"H <b>Finish:</b> Black-BL <b>* Only available to order by Carton.</b>	9616BL	112.00	336.00	3	15	30	2.56	150	
		<b>9618CH</b> Tall Rectangular Waste Receptacle 88 Quart Capacity 20¾"W x 11"D x 29½"H <b>Finish:</b> Charcoal-CH <b>* Only available to order by Carton.</b>	9618CH	228.00	684.00	3	42	67	6.08	150	

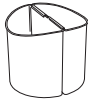
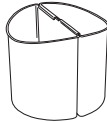
## Recycling Centers

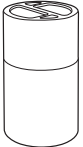
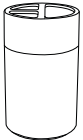
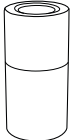
Model #	Description	Model #	List Price Ea.*	List Carton Price	Quantity Per Carton	Actual Weight	S-Parcel Billable Weight	Carton Cube	Freight Class
	<b>Tall Round Recycling Receptacle</b> <b>9632BU</b> Tall Round Recycling Receptacle/Can Lid 20 Gallon Capacity 16" Dia. x 30"H Finish: Blue-BU	9632BU	243.00	243.00	1	13	67	6.25	250
	<b>Paper Pitch</b> <b>2944BL</b> Paper Pitch 7 Quart Capacity 10 1/4"W x 6 1/4"D x 9"H Finish: Black-BL * Only available to order by Carton.	2944BL	15.00	180.00	12	9.4	13	1.22	125
	<b>Desk Side Receptacle</b> <b>9927BB</b> Desk Side Receptacle 3 Gallon Capacity Each 13"W x 8"D x 13 1/2"H Each Finish: Black/Blue-BB	9927BB	57.00	57.00	1	3	11	1.06	250
	<b>Desk Side Receptacle</b> <b>9928BB</b> Desk Side Receptacle 7 Gallon Capacity Each 17 1/2"W x 9 1/2"D x 16 1/2"H Each Finish: Black/Blue-BB	9928BB	77.00	77.00	1	5	22	2.0	250
	<b>Can Can™ Desk Side Recycling Receptacle</b> <b>9929BL</b> Can Can™ Desk Side Recycling Receptacle 5 Gallon Capacity, Recycle Bin Holds 100 Sheets 12 1/4"W x 13 3/4"D x 13"H Finish: Black-BL	9929BL	63.00	63.00	1	5	16	1.47	250
	<b>Dual Recycling Receptacle</b> <b>9931SS</b> Dual Recycling Receptacle 30 Gallon Capacity, 15 Gallon Each Side 17 1/2" Dia. x 32 1/2"H Finish: Brushed Aluminum-SS	9931SS	998.00	998.00	1	38	85	8.16	150
	<b>Triple Recycling Receptacle</b> <b>9941SS</b> Triple Recycling Receptacle 40 Gallon Capacity, 20 Gallon and two 10 Gallon 20" Dia. x 33"H Finish: Brushed Aluminum-SS	9941SS	1,440.00	1,440.00	1	44	110	10.5	250
	<b>Recycling Receptacle</b> <b>9942SS</b> Recycling Receptacle 20 Gallon Capacity 15" Dia. x 31"H Finish: Brushed Aluminum-SS	9942SS	622.00	622.00	1	19	65	6.1	150



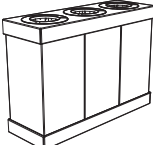





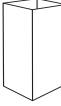

## At-Your-Disposal® Recycling Center

	<b>At-Your-Disposal® Recycling Center</b> <b>9794BL</b> At-Your-Disposal® Recycling Center, Double Bin 28 Gallon Capacity per Bin 31"W x 16"D x 33"H Finish: Black-BL	9794BL	321.00	321.00	1	16	59	5.18	250
	<b>At-Your-Disposal® Recycling Center</b> <b>9798BL</b> At-Your-Disposal® Recycling Center 28 Gallon Capacity per Bin 46"W x 16"D x 33"H Finish: Black-BL	9798BL	420.00	420.00	1	20	67	5.81	250

Office Suites  
Seating  
Tables & Desks  
Meeting Essentials  
Personal Organization  
Ergonomics  
High Density Storage  
Storage & Filing  
Facilities  
Technology Furniture  
Art & Engineering  
K-12 Education  
SAFE Collection Addendum

# Public Square® Recycling Receptacles

Safco® Products marketing materials are designed to be used as sales tools for our Dealer network.

Model #	Description	Model #	List Price Ea.	List Carton Price	Quantity Per Carton	Actual Weight	S-Parcel Billable Weight	Carton Cube	Freight Class
	<b>Public Square®</b> <b>2981</b> Public Square® Base - 26" 25 Gallon Capacity 15¼"W x 15¼"D x 26"H <b>Finish:</b> Black-BL, Green-GN	2981BL 2981GN	404.00	404.00	1	23	49	4.78	150
	<b>2982</b> Public Square® Base - 32" 31 Gallon Capacity 15¼"W x 15¼"D x 32"H <b>Finish:</b> Black-BL, Brown-BR	2982BL 2982BR	450.00	450.00	1	27	60	5.85	150
	<b>2983</b> Public Square® Base - 38" 37 Gallon Capacity 15¼"W x 15¼"D x 38"H <b>Finish:</b> Black-BL, Burgundy-BG	2983BL 2983BG	497.00	497.00	1	32	70	6.84	150
	<b>2984</b> Public Square® Base - 44" 42 Gallon Capacity 15¼"W x 15¼"D x 44"H <b>Finish:</b> Black-BL, Brown-BR	2984BL 2984BR	542.00	542.00	1	36	81	7.88	150
	<b>2987BL</b> Public Square® Lid, Paper Slot, 2 x 15" Slot <b>Finish:</b> Black-BL	2987BL	164.00	164.00	1	5	5	0.21	925
	<b>2988BL</b> Public Square® Lid, Cans/Glass Hole, 4" Dia. Opening <b>Finish:</b> Black-BL	2988BL	164.00	164.00	1	5	5	0.21	925
	<b>2989BL</b> Public Square® Lid, Waste Square, 8" Square Opening <b>Finish:</b> Black-BL	2989BL	164.00	164.00	1	5	5	0.21	925
	<b>2990CZ</b> Square-Fecta™ Cans Lid, 15½"sq. x 3"H <b>Finish:</b> Silver Powder coat	2990CZ	225.00	225.00	1	5.6	7	0.67	150
	<b>2990PA</b> Square-Fecta™ Paper Lid, 15½"sq. x 3"H <b>Finish:</b> Silver Powder coat	2990PA	225.00	225.00	1	5.6	7	0.67	150
	<b>2990PC</b> Square-Fecta™ Plastic Lid, 15½"sq. x 3"H <b>Finish:</b> Silver Powder coat	2990PC	225.00	225.00	1	5.6	7	0.67	150
	<b>2990RE</b> Square-Fecta™ Recycle Lid, 15½"sq. x 3"H <b>Finish:</b> Silver Powder coat	2990RE	225.00	225.00	1	5.6	7	0.67	150
	<b>2990WA</b> Square-Fecta™ Waste Lid, 15½"sq. x 3"H <b>Finish:</b> Silver Powder coat	2990WA	225.00	225.00	1	5.6	7	0.67	150

Contact [specials@safcoproducts.com](mailto:specials@safcoproducts.com) for customization.



These products are subject to California Proposition 65. Please visit the product detail page on our website for specific information.

Office Suites  
Seating  
Tables & Desks  
Meeting Essentials  
Personal Organization  
Ergonomics  
High Density Storage  
Storage & Filing  
Facilities  
Technology Furniture  
Art & Engineering  
K-12 Education  
SAFE Collection Addendum

Safco® Products marketing materials are designed to be used as sales tools for our Dealer network.

## Trifecta® Waste Receptacles

Model #	Description	Model #	List Price Ea.	Carton Price	Quantity Per Carton	Actual Weight	S-Parcel Billable Weight	Carton Cube	Freight Class
<b>Trifecta® Waste Receptacles</b>									
	<b>9550BL</b>	Trifecta® Waste Receptacle Base - 26"H 15 Gallon Capacity 19½", 3 Equal Sides <b>Finish: Black-BL</b>	9550BL	528.00	528.00	1	29	70	6.87 150
	<b>9551BL</b>	Trifecta® Waste Receptacle Base - 30"H 17 Gallon Capacity 19½", 3 Equal Sides <b>Finish: Black-BL</b>	9551BL	585.00	585.00	1	31	80	7.75 150
	<b>9552BL</b>	Trifecta® Waste Receptacle Base - 34"H 19 Gallon Capacity 19½", 3 Equal Sides <b>Finish: Black-BL</b>	9552BL	623.00	623.00	1	33	89	8.7 250
	<b>9553BL</b>	Trifecta® Waste Receptacle Base - 38"H 21 Gallon Capacity 19½", 3 Equal Sides <b>Finish: Black-BL</b>	9553BL	661.00	661.00	1	35	99	9.59 250
	<b>9560WA</b>	Trifecta® Waste Lid, 20", 3 Equal Sides, 3"H <b>Finish: Stainless Steel</b>	9560WA	275.00	275.00	1	5	11	0.92 250
	<b>9560CZ</b>	Trifecta® Cans Lid, 20", 3 Equal Sides, 3"H <b>Finish: Stainless Steel</b>	9560CZ	275.00	275.00	1	5	11	0.92 250
	<b>9560PA</b>	Trifecta® Paper Lid, 20", 3 Equal Sides, 3"H <b>Finish: Stainless Steel</b>	9560PA	275.00	275.00	1	5	11	0.92 250
	<b>9560PC</b>	Trifecta® Plastic Lid, 20", 3 Equal Sides, 3"H <b>Finish: Stainless Steel</b>	9560PC	275.00	275.00	1	5	11	0.92 250
	<b>9560RE</b>	Trifecta® Recycle Lid, 20", 3 Equal Sides, 3"H <b>Finish: Stainless Steel</b>	9560RE	275.00	275.00	1	5	11	0.92 250
	<b>9560BL</b>	Trifecta® Blank Lid, 20", 3 Equal Sides, 3"H <b>Finish: Stainless Steel</b>	9560BL	275.00	275.00	1	5	11	0.92 250

### Trifecta® Waste Receptacle Base Custom Designer Colors

Choose from the in-stock Black (BL) Base or the 19 additional special order colors. Candy Red (CD), Charcoal Gray (CG), Chestnut Brown (CN), Clay White (CW), Desert Sand (DS), Granite Speckle (GS), Ivory White (IW), Magnum Brown (MM), Midnight Blue (MT), Moss Green (MG), Pine Green (PN), Recycle Blue (RB), Shadow Gray (SH), Storm Gray (SM), Sunflower Yellow (SY), Timberwolf Gray (TG), White (WH), Wine Burgundy (WE).

Designer colors are available for the bases, along with custom laser inscription on the lid.

Please contact Safco® Customer Care at 888-971-6225 or [info@safcoproducts.com](mailto:info@safcoproducts.com) for pricing. Contact [specials@safcoproducts.com](mailto:specials@safcoproducts.com) for customization.

TO ORDER, PLEASE SPECIFY: \_\_\_\_\_ + \_\_\_\_\_ + 9 5 6 0 \_\_\_\_\_  
BASE # BASE COLOR LID

## Mixx™ Recycling Center

<b>Mixx™ Recycling Center – See website for custom vinyl decals</b>									
	<b>9447</b>	Mixx™ Half Round Receptacle 23 Gallon Capacity 10¼"W x 20¼"D x 32¼"H <b>Finish: Black-BL, Blue-BU, Green-GN</b>	9447BL 9447BU 9447GN 9447*	605.00	605.00	1	25.4	77	7.06 150
		Mixx™ Recycling Optional Vinyl Decals <b>*Visit Safco® website for ordering information: <a href="http://www.safcoproducts.com">www.safcoproducts.com</a></b>	Upcharge	73.00	73.00				
	<b>9448</b>	Mixx™ Rectangular Receptacle 29 Gallon Capacity 10¼"W x 20¼"D x 32¼"H <b>Finish: Black-BL, Blue-BU, Green-GN</b>	9448BL 9448BU 9448GN 9448*	605.00	605.00	1	25.4	77	7.06 150
		Mixx™ Recycling Optional Vinyl Decals <b>*Visit Safco® website for ordering information: <a href="http://www.safcoproducts.com">www.safcoproducts.com</a></b>	Upcharge	73.00	73.00				
	<b>9449</b>	Mixx™ Topper Lid 10"W x 20"D x 8¼"H <b>Finish: Black-BL, Blue-BU, Green-GN</b>	9449BL 9449BU 9449GN 9449*	180.00	180.00	1	6	21	1.97 150
		Mixx™ Recycling Optional Vinyl Decals <b>*Visit Safco® website for ordering information: <a href="http://www.safcoproducts.com">www.safcoproducts.com</a></b>	Upcharge	73.00	73.00				
	<b>9450</b>	Mixx™ Rectangular Lid 10"W x 20"D x ¾"H <b>Finish: Black-BL, Blue-BU, Green-GN</b>	9450BL 9450BU 9449GN	180.00	180.00	1	2.5	5	0.36 925
	<b>9651</b>	Mixx™ Half Round Plastic Liner 21 Gallon Capacity 8"W x 16¼"D x 30¾"H <b>Finish: Black-BL</b>	9651	124.00	124.00	1	5	26	2.37 300
	<b>9652</b>	Mixx™ Rectangular Plastic Liner 27 Gallon Capacity 8¼"W x 16¼"D x 30¾"H <b>Finish: Black-BL</b>	9652	124.00	124.00	1	6	26	2.37 300





These products are subject to California Proposition 65. Please visit the product detail page on our website for specific information.

Office Suites  
Seating  
Tables & Desks  
Meeting Essentials  
Personal Organization  
Ergonomics  
High Density Storage  
Storage & Filing  
Facilities  
Technology Furniture  
Art & Engineering  
Education  
SAFE Collection Addendum

# Archival & Boltless Shelving

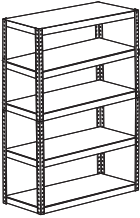
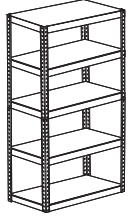
Safco® Products marketing materials are designed to be used as sales tools for our Dealer network.

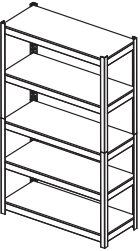
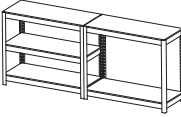

Model #	Description	Model #	List Price Ea.	List Carton Price	Quantity Per Carton	Actual Weight	S-Parcel Billable Weight	Carton Cube	Freight Class
<b>Archival &amp; Boltless Shelving</b>									
	<b>5244BL</b> Boltless Shelving - 48 x 24" Weight Capacity: 650 lbs./Shelf 48"W x 24"D x 72"H <b>Finish: Black-BL</b>	5244BL	518.00	518.00	1	89	89	2.53	70
	<b>5247BL</b> Boltless Shelving - 36 x 24" Weight Capacity: 750 lbs./Shelf 36"W x 24"D x 72"H <b>Finish: Black-BL</b>	5247BL	444.00	444.00	1	89	89	1.87	70
	<b>5245BL</b> Boltless Shelving - 36 x 18" Weight Capacity: 850 lbs./Shelf 36"W x 18"D x 72"H <b>Finish: Black-BL</b>	5245BL	379.00	379.00	1	72	72	1.62	70
	<b>5246BL</b> Boltless Shelving - 48 x 18" Weight Capacity: 750 lbs./Shelf 48"W x 18"D x 72"H <b>Finish: Black-BL</b>	5246BL	452.00	452.00	1	89	89	2.09	70
	<b>5260</b> Archival Shelving Steel Pack 69"W x 33"D x 84"H	5260	514.00	514.00	1	105	105	0.98	70
	<b>5261</b> Archival Shelving Particleboard Shelves Weight Capacity: 900 lbs./Shelf 69"W x 33"D x 1/2"H	5261	596.00	596.00	Set/4	116	LTL	3.42	70
<b>Archival Shelving Steel Pack and Particleboard Shelves sold separately. Please order both.</b>									
<b>Boltless Steel &amp; Particleboard Shelving</b>									
	<b>6244BL</b> Boltless Steel & Particleboard Shelving - 48 x 24" Weight Capacity: 750 lbs./Shelf 48"W x 24"D x 72"H <b>Finish: Black-BL</b>	6244BL	551.00	551.00	1	109	LTL	4.02	70
	<b>6245BL</b> Boltless Steel & Particleboard Shelving - 36 x 18" Weight Capacity: 950 lbs./Shelf 36"W x 18"D x 72"H <b>Finish: Black-BL</b>	6245BL	431.00	431.00	1	75	LTL	1.59	70
	<b>6246BL</b> Boltless Steel & Particleboard Shelving - 48 x 18" Weight Capacity: 850 lbs./Shelf 48"W x 18"D x 72"H <b>Finish: Black-BL</b>	6246BL	494.00	494.00	1	108	LTL	2.76	70
	<b>6247BL</b> Boltless Steel & Particleboard Shelving - 36 x 24" Weight Capacity: 850 lbs./Shelf 36"W x 24"D x 72"H <b>Finish: Black-BL</b>	6247BL	470.00	470.00	1	92	LTL	3.05	70
Also configures as a workbench									



These products are subject to California Proposition 65. Please visit the product detail page on our website for specific information.

Office Suites  
Seating  
Tables & Desks  
Meeting Essentials  
Personal Organization  
Ergonomics  
High Density Storage  
Storage & Filing  
Facilities  
Technology Furniture  
Art & Engineering  
K-12 Education  
SAFE Collection Addendum

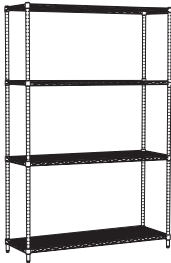
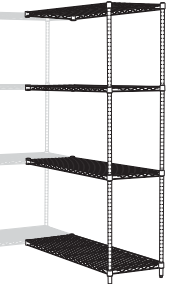
## Industrial Wire Shelving

Model #	Description	Model #	List Price Ea.	List Carton Price	Quantity Per Carton	Actual Weight	S-Parcel Billable Weight	Carton Cube	Freight Class
<b>Industrial Wire Shelving</b>									
	<b>5285</b> Industrial Shelving Starter Unit - 36 x 18" Weight Capacity: 1,250 lbs./Shelf 36"W x 18"D x 72"H Finish: Black-BL, Gray-GR	5285BL 5285GR	548.00	548.00	1	49	49	3.31	70
	<b>5291</b> Industrial Shelving Starter Unit - 48 x 18" Weight Capacity: 1,000 lbs./Shelf 48"W x 18"D x 72"H Finish: Black-BL, Gray-GR	5291BL 5291GR	578.00	578.00	1	62	62	3.7	70
	<b>5288</b> Industrial Shelving Starter Unit - 36 x 24" Weight Capacity: 1,000 lbs./Shelf 36"W x 24"D x 72"H Finish: Black-BL, Gray-GR	5288BL 5288GR	594.00	594.00	1	58	58	3.92	70
	<b>5294</b> Industrial Shelving Starter Unit - 48 x 24" Weight Capacity: 800 lbs./Shelf 48"W x 24"D x 72"H Finish: Black-BL, Gray-GR	5294BL 5294GR	624.00	624.00	1	68	68	5.19	70
	<b>5286</b> Industrial Add-On Unit - 36 x 18" Weight Capacity: 1,250 lbs./Shelf 36"W x 18"D x 72"H Finish: Black-BL, Gray-GR	5286BL 5286GR	518.00	518.00	1	44	44	2.83	70
	<b>5292</b> Industrial Add-On Unit - 48 x 18" Weight Capacity: 1,000 lbs./Shelf 48"W x 18"D x 72"H Finish: Black-BL, Gray-GR	5292BL 5292GR	556.00	556.00	1	55	55	3.66	70
	<b>5289</b> Industrial Add-On Unit - 36 x 24" Weight Capacity: 1,000 lbs./Shelf 36"W x 24"D x 72"H Finish: Black-BL, Gray-GR	5289BL 5289GR	578.00	578.00	1	51	52	3.87	70
	<b>5295</b> Industrial Add-On Unit - 48 x 24" Weight Capacity: 800 lbs./Shelf 48"W x 24"D x 72"H Finish: Black-BL, Gray-GR	5295BL 5295GR	617.00	617.00	1	62	62	5.09	70
	<b>5287</b> Industrial 2 Shelf Pack - 36 x 18" Weight Capacity: 1,250 lbs./Shelf 36"W x 18"D x 1 1/2"H Finish: Black-BL, Gray-GR	5287BL 5287GR	126.50	253.00	1	19	20	1.52	70
	<b>5293</b> Industrial 2 Shelf Pack - 48 x 18" Weight Capacity: 1,000 lbs./Shelf 48"W x 18"D x 1 1/2"H Finish: Black-BL, Gray-GR	5293BL 5293GR	131.00	262.00	1	22	24	2.18	70
	<b>5290</b> Industrial 2 Shelf Pack - 36 x 24" Weight Capacity: 1,000 lbs./Shelf 36"W x 24"D x 1 1/2"H Finish: Black-BL, Gray-GR	5290BL 5290GR	142.50	285.00	1	26	26	2.42	70
	<b>5296</b> Industrial 2 Shelf Pack - 48 x 24" Weight Capacity: 800 lbs./Shelf 48"W x 24"D x 1 1/2"H Finish: Black-BL, Gray-GR	5296BL 5296GR	153.00	306.00	1	28	31	2.74	70

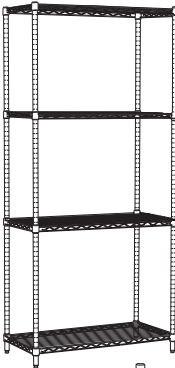

## Commercial Wire Shelving

Model #	Description	Model #	List Price Ea.	List Carton Price	Quantity Per Carton	Actual Weight	S-Parcel Billable Weight	Carton Cube	Freight Class
<b>Commercial Wire Shelving</b>									
	<b>5276BL</b> Commercial Shelving Starter Unit - 36 x 18" Weight Capacity: 500 lbs./Shelf 36"W x 18"D x 72"H Finish: Black-BL	5276BL	376.00	376.00	1	46	46	3.27	70
	<b>5241BL</b> Commercial Wire Shelving Starter Unit - 48 x 18" Weight Capacity: 500 lbs./Shelf 48"W x 18"D x 72"H Finish: Black-BL	5241BL	418.00	418.00	1	52	53	3.81	70
	<b>5242BL</b> Extra Commercial Wire Shelves (2 Pack) - 48 x 18" Weight Capacity: 500 lbs./Shelf 48"W x 18"D x 1"H Finish: Black-BL	5242BL	215.00	430.00	1	21	23	2.03	70
	<b>5243BL</b> Extra Commercial Wire Shelves (2 Pack) - 36 x 18" Weight Capacity: 500 lbs./Shelf 36"W x 18"D x 1"H Finish: Black-BL	5243BL	175.00	350.00	2	16	18	1.65	70
	<b>5283</b> Caster Kit 5" Dia.	5283	244.00	244.00	1	12	12	0.42	65



Office Suites  
Seating  
Tables & Desks  
Meeting Essentials  
Personal Organization  
Ergonomics  
High Density Storage  
Storage & Filing  
Facilities  
Technology Furniture  
Art & Engineering  
Education  
K-12  
SAFE Collection Addendum

# Steel Shelving

Safco® Products marketing materials are designed to be used as sales tools for our Dealer network.

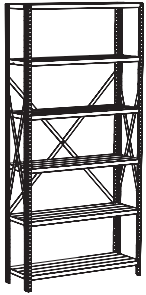
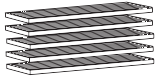
Model #	Description	Model #	List Price Ea.	List Carton Price	Quantity Per Carton	Actual Weight	S-Parcel Billable Weight	Carton Cube	Freight Class
<b>Commercial Steel Shelving - 75"H</b>  									
6265	Commercial Steel Shelving 36 x 12", 5 Shelf Kit Weight Capacity: 750 lbs./Shelf	6265	321.00	321.00	1	55	55	2.63	70
6266	Commercial Steel Shelving 36 x 18", 5 Shelf Kit Weight Capacity: 700 lbs./Shelf	6266	347.00	347.00	1	63	63	4.03	70
6267	Commercial Steel Shelving 36 x 24", 5 Shelf Kit Weight Capacity: 650 lbs./Shelf	6267	422.00	422.00	1	73	73	5.24	70
6268	Commercial Steel Shelving 36 x 12", 6 Shelf Kit Weight Capacity: 750 lbs./Shelf	6268	347.00	347.00	1	60	60	2.81	70
6269	Commercial Steel Shelving 36 x 18", 6 Shelf Kit Weight Capacity: 650 lbs./Shelf	6269	422.00	422.00	1	72	72	3.93	70
6270	Commercial Steel Shelving 36 x 24", 6 Shelf Kit Weight Capacity: 650 lbs./Shelf <b>Finish: Dark Gray</b>	6270	470.00	470.00	1	82	82	5.24	70





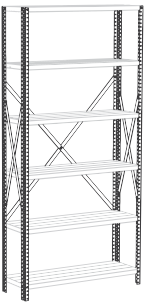

















<b>Industrial Steel Shelving</b>  									
6252	Industrial Steel Shelving 18 x 36", 6 Shelf Pack Weight Capacity: 1,200 lbs./Shelf	6252	338.00	338.00	1	62	62	3.15	70
6253	Industrial Steel Shelving 18 x 48", 6 Shelf Pack Weight Capacity: 950 lbs./Shelf	6253	470.00	470.00	1	79	79	4.36	70
6254	Industrial Steel Shelving 24 x 36", 6 Shelf Pack Weight Capacity: 1,150 lbs./Shelf	6254	411.00	411.00	1	75	75	4.16	70
6255	Industrial Steel Shelving 24 x 48", 6 Shelf Pack Weight Capacity: 900 lbs./Shelf <b>Finish: Dark Gray</b>	6255	535.00	535.00	1	99	99	5.49	70
6256	Industrial Post Kit 1 1/2"W x 1 1/2"D x 85"H <b>Finish: Dark Gray</b> Post Kit includes four 85" high posts.	6256	211.00	211.00	1	22	23	0.38	70







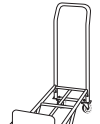

**Industrial Steel Shelving Pack and Industrial Post Kit are shipped separately. Please order both.**

Office Suites  
Seating  
Tables & Desks  
Meeting Essentials  
Personal Organization  
Ergonomics  
High Density Storage  
Storage & Filing  
Facilities  
Technology Furniture  
Art & Engineering  
K-12 Education  
SAFE Collection Addendum

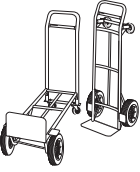

	Model #	Description	Model #	List Price Ea.	List Carton Price	Quantity Per Carton	Actual Weight	S-Parcel Billable Weight	Carton Cube	Freight Class
	<b>4055NC</b>  	STOW AWAY® Heavy-Duty Hand Truck Capacity: 500 lbs. Size Extended: 23"W x 24"D x 50"H Size Collapsed: 23"W x 3"D x 39½"H Toe Plate: 23"W x 15½"D 8"Dia. solid rubber tires	4055NC	659.00	659.00	1	34	34	2.6	85
	<b>4062</b>  	STOW AWAY® Hand Truck Capacity: 275 lbs. Size Extended: 19"W x 17¾"D x 38¾"H Size Collapsed: 19"W x 2¾"D x 28¾"H Toe Plate: 19"W x 11"D 7"Dia. solid rubber tires	4062	333.00	333.00	1	17	18	1.63	925
	<b>4049NC</b>  	Stow and Go Cart™ Capacity: 110 lbs. Size Extended: 15¾"W x 16¾"D x 39½"H Size Collapsed: 15¾"W x 2½"D x 25"H Toe Plate: 15¾"W x 11"D 5"Dia. solid rubber retractable wheels	4049NC	209.00	209.00	1	8	8	0.82	100
	<b>4061</b>  	Hide-Away® Aluminum Hand Truck Capacity: 250 lbs. Size Extended: 15½"W x 16¾"D x 43¾"H Size Collapsed: 15½"W x 8"D x 29"H Toe Plate: 14"W x 9"D 6"Dia. rubber tires on steel hub	4061	211.00	211.00	1	15	24	2.19	125
	<b>4054BL</b>  	STOW AWAY® Crate Capacity: 50 lbs. Size Extended: 16½"W x 14¾"D x 39"H Size Collapsed: 16½"W x 3¾"D x 18"H Finish: Black-BL	4054BL	103.00	103.00	1	10	10	0.78	85
	<b>4050</b>  	Hide-Away® Convertible Hand Truck Capacity: 250 lbs./2 wheel 400 lbs./4 wheel Size Extended: 15½"W x 43"D x 36"H Size Collapsed: 15½"W x 9"D x 28¾"H Toe Plate: 14"W x 9"D Two 6" solid rubber wheels & two 3" solid rubber casters	4050	458.00	458.00	1	21	29	2.78	125
	<b>4086R</b>  	Heavy-Duty Convertible Handle Truck Capacity: 500 lbs./2 wheel 600 lbs./4 wheel Size: 18"W x 16"D x 51"H Toe Plate: 14"W x 8"D Tire Size: 10 x 2¾"	4086R	857.00	857.00	1	35	92	8.96	250

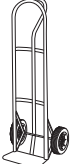
Economy Hand Trucks



	<b>4069</b>  	Economy C-Loop Steel Hand Truck Capacity: 400 lbs. Size: 19½"W x 14½"D x 45½"H Toe Plate: 14"W x 7"D Tire Size: 8 x 1¾"	4069	269.00	269.00	1	23	85	7.82	250
	<b>4070</b>  	Economy Convertible Steel Hand Truck Capacity: 400 lbs./2 wheel 500 lbs./4 wheel Size: 18¾"W x 12"D x 52"H Toe Plate: 14"W x 7"D Tire Size: 8 x 1¾"	4070	303.00	303.00	1	28	83	7.63	250
	<b>4071</b>  	Economy P-Handle Steel Hand Truck Capacity: 400 lbs. Size: 16"W x 16¾"D x 51½"H Toe Plate: 14"W x 7"D Tire Size: 8 x 1¾"	4071	251.00	251.00	1	20	81	7.74	250

Office Suites  
Seating  
Tables & Desks  
Meeting Essentials  
Personal Organization  
Ergonomics  
High Density Storage  
Storage & Filing  
Facilities  
Technology Furniture  
Art & Engineering  
K-12 Education  
SAFE Collection Addendum







# Platform Trucks

Safco® Products marketing materials are designed to be used as sales tools for our Dealer network.







	Model #	Description	Model #	List Price Ea.	List Carton Price	Quantity Per Carton	Actual Weight	S-Parcel Billable Weight	Carton Cube	Freight Class
	<b>4053NC</b>	STOW AWAY® Platform Truck Capacity: 1,000 lbs. Size: 24"W x 39"D x 40"H Platform Size: 24"W x 39"D Tire Size: 7"Dia.	4053NC	906.00	906.00	1	52	54	5.08	925
	<b>4063</b>	Large Economy Platform Truck Capacity: 500 lbs. Size: 24"W x 36"D x 34"H Platform Size: 24"W x 36"D Tire Size: 4 x 1"	4063	341.00	341.00	1	42	42	3.38	85
	<b>4072</b>	Small Economy Platform Truck Capacity: 400 lbs. Size: 18"W x 29"D x 33½"H Platform Size: 18"W x 29"D Tire Size: 4 x 1"	4072	229.00	229.00	1	22	22	2.01	925

# Mailroom Carts



	<b>5235GR</b>	Wire Mail Cart - 24" Holds 75 legal folders Weight Capacity: 200 lbs./Shelf 26½"W x 18½"D x 38½"H Finish: Gray-GR	5235GR	580.00	580.00	1	40	40	2.46	70
	<b>5236GR</b>	Wire Mail Cart - 36" Holds 150 legal folders Weight Capacity: 200 lbs./Shelf 39"W x 18½"D x 38½"H Finish: Gray-GR	5236GR	716.00	716.00	1	47	47	3.8	70
	<b>5238BL</b>	Scoot™ Steel Mail Cart - 20" Holds 75 legal folders Weight Capacity: 300 lbs. 22"W x 27"D x 40½"H Finish: Black-BL	5238BL	613.00	613.00	1	44	44	3.7	925
	<b>5239BL</b>	Scoot™ Steel Mail Cart - 32" Holds 150 legal folders Weight Capacity: 300 lbs. 22½"W x 39½"D x 40½"H Finish: Black-BL	5239BL	854.00	854.00	1	55	55	3.82	85



Office Suites  
Seating  
Tables & Desks  
Meeting Essentials  
Personal Organization  
Ergonomics  
High Density Storage  
Storage & Filing  
Facilities  
Technology Furniture  
Art & Engineering  
K-12 Education  
SAFE Collection Addendum

Model #	Description	Model #	List Price Ea.	List Carton Price	Quantity Per Carton	Actual Weight	S-Parcel Billable Weight	Carton Cube	Freight Class
<b>Mailroom</b>									
 <b>7749</b>	Sorting Table Base/Shelf 60"W x 30"D x 28-36"H Finish: Black-BL, Gray-GR	7749BL 7749GR	1,183.00	1,183.00	1	59	59	2.34	100
 <b>7750</b>	Sorting Tabletop 60"W x 30"D x 1"H Finish: Gray-GR	7750GR	494.00	494.00	1	64	64	2.02	70
 <b>7751</b>	Sorter Module 57½"W x 13"D x 14¼"H Finish: Black-BL, Gray-GR	7751BL 7751GR	818.00	818.00	1	57	57	2.77	100
 <b>7752</b>	Riser 57½"W x 13"D x 14"H Finish: Black-BL, Gray-GR	7752BL 7752GR	480.00	480.00	1	28	28	1.43	100
 <b>7753</b>	Additional Mail Trays 11"W x 12½"D x ½"H Finish: Black-BL, Gray-GR	7753BL 7753GR	106.00	106.00	5/Pack	4	6	0.5	70
 <b>7756</b>	Satellite Mail Station Base 57½"W x 18¼"D x 14" to 19"H Finish: Black-BL, Gray-GR	7756BL 7756GR	811.00	811.00	1	30	30	1.54	100

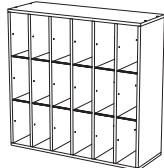
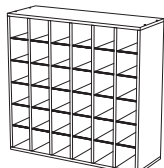
**Mail Sorters**

Model #	Description	Model #	List Price Ea.	List Carton Price	Quantity Per Carton	Actual Weight	S-Parcel Billable Weight	Carton Cube	Freight Class
<b>Mail Sorters</b>									
 <b>7765</b>	Mail Sorter - 18 Compartment 33¾"W x 12"D x 32¾"H Finish: Black-BL	7765BL	393.00	393.00	1	63	63	1.91	85
 <b>7766</b>	Mail Sorter - 36 Compartment 33¾"W x 12"D x 32¾"H Finish: Black-BL	7766BL	443.00	443.00	1	62	62	1.9	85
 <b>7770</b>	Onyx™ Mail Sorter - 20 Compartment 56¾"W x 12¾"D x 32½"H Finish: Black-BL	7770BL	509.00	509.00	1	62	62	9.89	70

Office Suites  
Seating  
Tables & Desks  
Meeting Essentials  
Personal Organization  
Ergonomics  
High Density Storage  
Storage & Filing  
Facilities  
Technology Furniture  
Art & Engineering  
K-12 Education  
SAFE Collection Addendum

# Mailflow Systems® - Closed-Back Sorters

Safco® Products marketing materials are designed to be used as sales tools for our Dealer network.

- All sorters are 15" deep
- 50 lb. weight capacity per shelf
- Shelves adjustable on .5" increments
- Available in Safco® Corporate Colors see page 10 or go to [Safcoproducts.com](http://Safcoproducts.com) for more information
- For assistance with custom Mailflow Systems configuration contact Safco Sales Rep Group

Closed-Back Sorter (SC7233G)

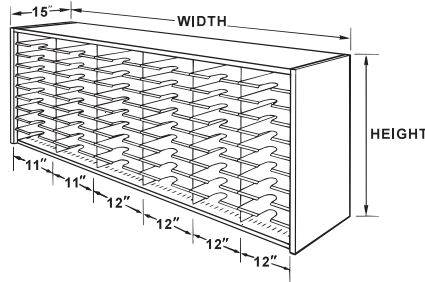



SC2424G

Model #	Description	Model #	List Price Ea.	List Carton Price	Quantity Per Carton	Actual Weight	S-Parcel Billable Weight	Carton Cube	Freight Class
SC2424	Mailflow System® Closed-Back Sorter Shelf Capacity: 14 2 columns of 11"W Shelves Size: 24"W x 15"D x 24"H Size (Inside): 22"W x 15"D x 21"H 14 Sorting Pockets 15"D without Plexi Doors - G	SC2424G	2,172.00	2,172.00	1	80	-	-	-
SC2433	Mailflow System® Closed-Back Sorter Shelf Capacity: 20 2 columns of 11"W Shelves Size: 24"W x 15"D x 33"H Size (Inside): 22"W x 15"D x 30"H 20 Sorting Pockets 15"D without Plexi Doors - G	SC2433G	2,694.00	2,694.00	1	106	-	-	-
SC2441	Mailflow System® Closed-Back Sorter Shelf Capacity: 24 2 columns of 11"W Shelves Size: 24"W x 15"D x 41"H Size (Inside): 22"W x 15"D x 38"H 24 Sorting Pockets 15"D without Plexi Doors - G	SC2441G	3,025.00	3,025.00	1	127	-	-	-
SC2448	Mailflow System® Closed-Back Sorter Shelf Capacity: 30 2 columns of 11"W Shelves Size: 24"W x 15"D x 48"H Size (Inside): 22"W x 15"D x 45"H 30 Sorting Pockets 15"D without Plexi Doors - G	SC2448G	3,316.00	3,316.00	1	152	-	-	-

**Note:** All preconfigured models are standard with two columns of 11" wide shelves and the remaining columns with 12" wide shelves. You may receive extra shelves with preconfigured sorters.

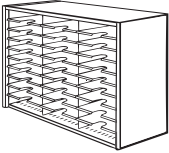
Office Suites  
Seating  
Tables & Desks  
Meeting Essentials  
Personal Organization  
Ergonomics  
High Density Storage  
Storage & Filing  
Facilities  
Technology Furniture  
Art & Engineering  
K-12 Education  
SAFE Collection Addendum

Model #	Description	Model #	List Price Ea.	List Carton Price	Quantity Per Carton	Actual Weight	S-Parcel Billable Weight	Carton Cube	Freight Class
 <p>SC3624G</p>	<b>SC3624</b> Mailflow System® Closed-Back Sorter Shelf Capacity: 21 2 columns of 11"W & 1 column 12"W Shelves Size: 36"W x 15"D x 24"H Size (Inside): 34"W x 15"D x 21"H 21 Sorting Pockets 15"D without Plexi Doors - G	SC3624G	2,276.00	2,276.00	1	115	-	-	-
	<b>SC3633</b> Mailflow System® Closed-Back Sorter Shelf Capacity: 30 2 columns of 11"W & 1 column 12"W Shelves Size: 36"W x 15"D x 33"H Size (Inside): 34"W x 15"D x 30"H 30 Sorting Pockets 15"D without Plexi Doors - G	SC3633G	2,995.00	2,995.00	1	152	-	-	-
	<b>SC3641</b> Mailflow System® Closed-Back Sorter Shelf Capacity: 36 2 columns of 11"W & 1 column 12"W Shelves Size: 36"W x 15"D x 41"H Size (Inside): 34"W x 15"D x 38"H 36 Sorting Pockets 15"D without Plexi Doors - G	SC3641G	3,168.00	3,168.00	1	181	-	-	-
	<b>SC3648</b> Mailflow System® Closed-Back Sorter Shelf Capacity: 45 2 columns of 11"W & 1 column 12"W Shelves Size: 36"W x 15"D x 48"H Size (Inside): 34"W x 15"D x 45"H 45 Sorting Pockets 15"D without Plexi Doors - G	SC3648G	3,662.00	3,662.00	1	218	-	-	-
	<b>SC4824</b> Mailflow System® Closed-Back Sorter Shelf Capacity: 28 2 columns of 11"W & 2 column 12"W Shelves Size: 48"W x 15"D x 24"H Size (Inside): 46"W x 15"D x 21"H 28 Sorting Pockets 15"D without Plexi Doors - G	SC4824G	3,282.00	3,282.00	1	150	-	-	-
 <p>SC4824G</p>	<b>SC4833</b> Mailflow System® Closed-Back Sorter Shelf Capacity: 40 2 columns of 11"W & 2 column 12"W Shelves Size: 48"W x 15"D x 33"H Size (Inside): 46"W x 15"D x 30"H 40 Sorting Pockets 15"D without Plexi Doors - G	SC4833G	3,991.00	3,991.00	1	198	-	-	-
	<b>SC4841</b> Mailflow System® Closed-Back Sorter Shelf Capacity: 48 2 columns of 11"W & 2 column 12"W Shelves Size: 48"W x 15"D x 41"H Size (Inside): 46"W x 15"D x 38"H 48 Sorting Pockets 15"D without Plexi Doors - G	SC4841G	4,493.00	4,493.00	1	235	-	-	-
	<b>SC4848</b> Mailflow System® Closed-Back Sorter Shelf Capacity: 60 2 columns of 11"W & 2 column 12"W Shelves Size: 48"W x 15"D x 48"H Size (Inside): 46"W x 15"D x 45"H 60 Sorting Pockets 15"D without Plexi Doors - G	SC4848G	5,514.00	5,514.00	1	283	-	-	-

Note: All preconfigured models are standard with two columns of 11" wide shelves and the remaining columns with 12" wide shelves. You may receive extra shelves with preconfigured sorters.

Office Suites  
Seating  
Tables & Desks  
Meeting Essentials  
Personal Organization  
Ergonomics  
High Density Storage  
Storage & Filing  
Facilities  
Technology Furniture  
Art & Engineering  
K-12 Education  
SAFE Collection Addendum

# Mailflow Systems® - Closed-Back Sorters

Safco® Products marketing materials are designed to be used as sales tools for our Dealer network.

Model #	Description	Model #	List Price Ea.	List Carton Price	Quantity Per Carton	Actual Weight	S-Parcel Billable Weight	Carton Cube	Freight Class
<b>SC6024</b>	Mailflow System® Closed-Back Sorter Shelf Capacity: 35 2 columns of 11"W & 3 column 12"W Shelves Size: 60"W x 15"D x 24"H Size (Inside): 58"W x 15"D x 21"H 35 Sorting Pockets 15"D without Plexi Doors - G	SC6024G	3,752.00	3,752.00	1	185	-	-	-
<b>SC6033</b>	Mailflow System® Closed-Back Sorter Shelf Capacity: 50 2 columns of 11"W & 3 column 12"W Shelves Size: 60"W x 15"D x 33"H Size (Inside): 58"W x 15"D x 30"H 50 Sorting Pockets 15"D without Plexi Doors - G	SC6033G	4,725.00	4,725.00	1	230	-	-	-
<b>SC6041</b>	Mailflow System® Closed-Back Sorter Shelf Capacity: 60 2 columns of 11"W & 3 column 12"W Shelves Size: 60"W x 15"D x 41"H Size (Inside): 58"W x 15"D x 38"H 60 Sorting Pockets 15"D without Plexi Doors - G	SC6041G	5,433.00	5,433.00	1	261	-	-	-
<b>SC6048</b>	Mailflow System® Closed-Back Sorter Shelf Capacity: 75 2 columns of 11"W & 3 column 12"W Shelves Size: 60"W x 15"D x 48"H Size (Inside): 58"W x 15"D x 45"H 75 Sorting Pockets 15"D without Plexi Doors - G	SC6048G	6,386.00	6,386.00	1	306	-	-	-
<b>SC7224</b>	Mailflow System® Closed-Back Sorter Shelf Capacity: 42 2 columns of 11"W & 4 column 12"W Shelves Size: 72"W x 15"D x 24"H Size (Inside): 70"W x 15"D x 21"H 42 Sorting Pockets 15"D without Plexi Doors - G	SC7224G	4,451.00	4,451.00	1	214	-	-	-
<b>SC7233</b>	Mailflow System® Closed-Back Sorter Shelf Capacity: 60 2 columns of 11"W & 4 column 12"W Shelves Size: 72"W x 15"D x 33"H Size (Inside): 70"W x 15"D x 30"H 60 Sorting Pockets 15"D without Plexi Doors - G	SC7233G	5,585.00	5,585.00	1	269	-	-	-
<b>SC7241</b>	Mailflow System® Closed-Back Sorter Shelf Capacity: 72 2 columns of 11"W & 4 column 12"W Shelves Size: 72"W x 15"D x 41"H Size (Inside): 70"W x 15"D x 38"H 72 Sorting Pockets 15"D without Plexi Doors - G	SC7241G	6,351.00	6,351.00	1	309	-	-	-
<b>SC7248</b>	Mailflow System® Closed-Back Sorter Shelf Capacity: 90 2 columns of 11"W & 4 column 12"W Shelves Size: 72"W x 15"D x 48"H Size (Inside): 70"W x 15"D x 45"H 90 Sorting Pockets 15"D without Plexi Doors - G	SC7248G	7,502.00	7,502.00	1	364	-	-	-

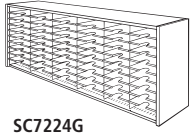

**Note:** All preconfigured models are standard with two columns of 11" wide shelves and the remaining columns with 12" wide shelves. You may receive extra shelves with sorters.

Office Suites  
Seating  
Tables & Desks  
Meeting Essentials  
Personal Organization  
Ergonomics  
High Density Storage  
Storage & Filing  
Facilities  
Technology Furniture  
Art & Engineering  
K-12 Education  
SAFE Collection Addendum

- All sorters are 15" deep
- Sorting shelves are 12", 14" or 15" deep. Adjust on 1/2" H increments
- Preconfigured models available, or build-your-own and adding components on page 233-235.
- Pricing below is for sorters without locking doors
- Available in Safco® Corporate Colors see page 10 or go to [Safcoproducts.com](http://Safcoproducts.com) for more information

**Elevated Closed-Back Sorter (SC4833GH)**

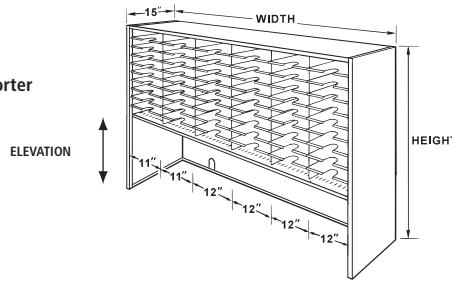

Model #	Description	Model #	List Price Ea.	List Carton Price	Quantity Per Carton	Actual Weight	S-Parcel Billable Weight	Carton Cube	Freight Class
SC2433	Mailflow System® Elevated 9"H Closed-Back Sorter Shelf Capacity: 14 2 columns of 11"W Shelves Size: 24"W x 15"D x 33"H Size (Inside): 22"W x 15"D x 21"H 14 Sorting Pockets 15"D without Plexi Doors - GL	SC2433GL	2,392.00	2,392.00	1	95	-	-	-
SC2441	Mailflow System® Elevated 8"H Closed-Back Sorter Shelf Capacity: 20 2 columns of 11"W Shelves Size: 24"W x 15"D x 41"H Size (Inside): 22"W x 15"D x 30"H 20 Sorting Pockets 15"D without Plexi Doors - GL	SC2441GL	2,903.00	2,903.00	1	111	-	-	-
SC2441GH	Mailflow System® Elevated 17"H Closed-Back Sorter Shelf Capacity: 14 2 columns of 11"W Shelves Size: 24"W x 15"D x 41"H Size (Inside): 22"W x 15"D x 21"H 14 Sorting Pockets 15"D without Plexi Doors - GH	SC2441GH	2,695.00	2,695.00	1	105	-	-	-
SC2448	Mailflow System® Elevated 7"H Closed-Back Sorter Shelf Capacity: 24 2 columns of 11"W Shelves Size: 24"W x 15"D x 48"H Size (Inside): 22"W x 15"D x 38"H 24 Sorting Pockets 15"D without Plexi Doors - GL	SC2448GL	3,219.00	3,219.00	1	132	-	-	-
SC2448GH	Mailflow System® Elevated 15"H Closed-Back Sorter Shelf Capacity: 20 2 columns of 11"W Shelves Size: 24"W x 15"D x 48"H Size (Inside): 22"W x 15"D x 30"H 20 Sorting Pockets 15"D without Plexi Doors - GH	SC2448GH	3,180.00	3,180.00	1	132	-	-	-

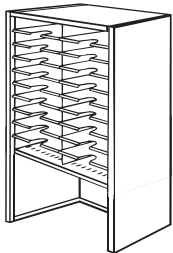

SC2433GL

**Note:** All preconfigured models are standard with two columns of 11" wide shelves and the remaining columns with 12" wide shelves. You may receive extra shelves with sorters.

Office Suites  
Seating  
Tables & Desks  
Meeting Essentials  
Personal Organization  
Ergonomics  
High Density Storage  
Storage & Filing  
Facilities  
Technology Furniture  
Art & Engineering  
K-12 Education  
SAFE Collection Addendum

# Mailflow Systems® - Elevated Closed-Back Sorters

Safco® Products marketing materials are designed to be used as sales tools for our Dealer network.

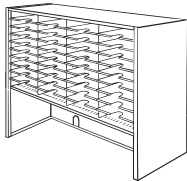
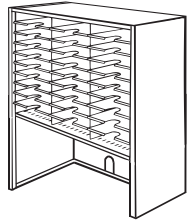

Model #	Description	Model #	List Price Ea.	List Carton Price	Quantity Per Carton	Actual Weight	S-Parcel Billable Weight	Carton Cube	Freight Class
SC3633GL	<b>SC3633</b> Mailflow System® Elevated 9"H Closed-Back Sorter Shelf Capacity: 21 2 columns of 11"W & 1 column 12"W Shelves Size: 36"W x 15"D x 33"H Size (Inside): 34"W x 15"D x 21"H 21 Sorting Pockets 15"D without Plexi Doors - GL	SC3633GL	2,679.00	2,679.00	1	128	-	-	-
	<b>SC3641</b> Mailflow System® Elevated 8"H Closed-Back Sorter Shelf Capacity: 30 2 columns of 11"W & 1 column 12"W Shelves Size: 36"W x 15"D x 41"H Size (Inside): 34"W x 15"D x 30"H 30 Sorting Pockets 15"D without Plexi Doors - GL	SC3641GL	3,457.00	3,457.00	1	168	-	-	-
	Mailflow System® Elevated 17"H Closed-Back Sorter Shelf Capacity: 21 2 columns of 11"W & 1 column 12"W Shelves Size: 36"W x 15"D x 41"H Size (Inside): 34"W x 15"D x 21"H 21 Sorting Pockets 15"D without Plexi Doors - GH	SC3641GH	2,879.00	2,879.00	1	149	-	-	-
SC3648GL	<b>SC3648</b> Mailflow System® Elevated 7"H Closed-Back Sorter Shelf Capacity: 36 2 columns of 11"W & 1 column 12"W Shelves Size: 36"W x 15"D x 48"H Size (Inside): 34"W x 15"D x 38"H 36 Sorting Pockets 15"D without Plexi Doors - GL	SC3648GL	3,889.00	3,889.00	1	198	-	-	-
	Mailflow System® Elevated 15"H Closed-Back Sorter Shelf Capacity: 20 2 columns of 11"W & 1 column 12"W Shelves Size: 36"W x 15"D x 48"H Size (Inside): 34"W x 15"D x 30"H 20 Sorting Pockets 15"D without Plexi Doors - GH	SC3648GH	3,755.00	3,755.00	1	187	-	-	-
	<b>SC4833</b> Mailflow System® Elevated 9"H Closed-Back Sorter Shelf Capacity: 28 2 columns of 11"W & 2 column 12"W Shelves Size: 48"W x 15"D x 33"H Size (Inside): 46"W x 15"D x 21"H 28 Sorting Pockets 15"D without Plexi Doors - GL	SC4833GL	3,386.00	3,386.00	1	160	-	-	-
SC4841GL	<b>SC4841</b> Mailflow System® Elevated 8"H Closed-Back Sorter Shelf Capacity: 40 2 columns of 11"W & 2 column 12"W Shelves Size: 48"W x 15"D x 41"H Size (Inside): 46"W x 15"D x 30"H 40 Sorting Pockets 15"D without Plexi Doors - GL	SC4841GL	4,307.00	4,307.00	1	224	-	-	-
	Mailflow System® Elevated 17"H Closed-Back Sorter Shelf Capacity: 28 2 columns of 11"W & 2 column 12"W Shelves Size: 48"W x 15"D x 41"H Size (Inside): 46"W x 15"D x 21"H 28 Sorting Pockets 15"D without Plexi Doors - GH	SC4841GH	3,588.00	3,588.00	1	193	-	-	-



**Note:** All preconfigured models are standard with two columns of 11" wide shelves and the remaining columns with 12" wide shelves. You may receive extra shelves with sorters.

Office Suites  
Seating  
Tables & Desks  
Meeting Essentials  
Personal Organization  
Ergonomics  
High Density Storage  
Storage & Filing  
Facilities  
Technology Furniture  
Art & Engineering  
K-12 Education  
SAFE Collection Addendum

## Mailflow Systems® - Elevated Closed-Back Sorters

Model #	Description	Model #	List Price Ea.	List Carton Price	Quantity Per Carton	Actual Weight	S-Parcel Billable Weight	Carton Cube	Freight Class
 SC4848GL	<b>SC4848</b> Mailflow System® Elevated 7" H Closed-Back Sorter Shelf Capacity: 48 2 columns of 11" W & 2 column 12" W Shelves Size: 48" W x 15" D x 48" H Size (Inside): 46" W x 15" D x 38" H 48 Sorting Pockets 15" D without Plexi Doors - GL	SC4848GL	5,255.00	5,255.00	1	263	-	-	-
	Mailflow System® Elevated 15" H Closed-Back Sorter Shelf Capacity: 40 2 columns of 11" W & 2 column 12" W Shelves Size: 48" W x 15" D x 48" H Size (Inside): 46" W x 15" D x 30" H 40 Sorting Pockets 15" D without Plexi Doors - GH	SC4848GH	4,613.00	4,613.00	1	241	-	-	-
 SC6033GL	<b>SC6033</b> Mailflow System® Elevated 9" H Closed-Back Sorter Shelf Capacity: 35 2 columns of 11" W & 3 column 12" W Shelves Size: 60" W x 15" D x 33" H Size (Inside): 58" W x 15" D x 21" H 35 Sorting Pockets 15" D without Plexi Doors - GL	SC6033GL	3,972.00	3,972.00	1	203	-	-	-
	<b>SC6041</b> Mailflow System® Elevated 8" H Closed-Back Sorter Shelf Capacity: 50 2 columns of 11" W & 3 column 12" W Shelves Size: 60" W x 15" D x 41" H Size (Inside): 58" W x 15" D x 30" H 50 Sorting Pockets 15" D without Plexi Doors - GL	SC6041GL	5,040.00	5,040.00	1	248	-	-	-
	Mailflow System® Elevated 17" H Closed-Back Sorter Shelf Capacity: 35 2 columns of 11" W & 3 column 12" W Shelves Size: 60" W x 15" D x 41" H Size (Inside): 58" W x 15" D x 21" H 35 Sorting Pockets 15" D without Plexi Doors - GH	SC6041GH	4,275.00	4,275.00	1	208	-	-	-
	<b>SC6048</b> Mailflow System® Elevated 7" H Closed-Back Sorter Shelf Capacity: 60 2 columns of 11" W & 3 column 12" W Shelves Size: 60" W x 15" D x 48" H Size (Inside): 58" W x 15" D x 38" H 60 Sorting Pockets 15" D without Plexi Doors - GL	SC6048GL	5,855.00	5,855.00	1	275	-	-	-
	Mailflow System® Elevated 15" H Closed-Back Sorter Shelf Capacity: 50 2 columns of 11" W & 3 column 12" W Shelves Size: 60" W x 15" D x 48" H Size (Inside): 58" W x 15" D x 30" H 50 Sorting Pockets 15" D without Plexi Doors - GH	SC6048GH	5,350.00	5,350.00	1	233	-	-	-

**Note:** All preconfigured models are standard with two columns of 11" wide shelves and the remaining columns with 12" wide shelves. You may receive extra shelves with sorters.

Office Suites  
Seating  
Tables & Desks  
Meeting Essentials  
Personal Organization  
Ergonomics  
High Density Storage  
Storage & Filing  
Facilities  
Technology Furniture  
Art & Engineering  
K-12 Education  
SAFE Collection Addendum



# Mailflow Systems® - Elevated Closed-Back Sorters

Safco® Products marketing materials are designed to be used as sales tools for our Dealer network.

Model #	Description	Model #	List Price Ea.	List Carton Price	Quantity Per Carton	Actual Weight	S-Parcel Billable Weight	Carton Cube	Freight Class
<b>SC7233</b>	Mailflow System® Elevated 9"H Closed-Back Sorter Shelf Capacity: 42 2 columns of 11"W & 4 column 12"W Shelves Size: 72"W x 15"D x 33"H Size (Inside): 70"W x 15"D x 21"H 42 Sorting Pockets 15"D without Plexi Doors - GL	SC7233GL	4,631.00	4,631.00	1	237	-	-	-
<b>SC7241</b>	Mailflow System® Elevated 8"H Closed-Back Sorter Shelf Capacity: 60 2 columns of 11"W & 4 column 12"W Shelves Size: 72"W x 15"D x 41"H Size (Inside): 70"W x 15"D x 30"H 60 Sorting Pockets 15"D without Plexi Doors - GL	SC7241GL	6,075.00	6,075.00	1	292	-	-	-
<b>SC7233GL</b>	Mailflow System® Elevated 17"H Closed-Back Sorter Shelf Capacity: 42 2 columns of 11"W & 4 column 12"W Shelves Size: 72"W x 15"D x 41"H Size (Inside): 70"W x 15"D x 21"H 42 Sorting Pockets 15"D without Plexi Doors - GH	SC7241GH	5,103.00	5,103.00	1	245	-	-	-
<b>SC7248</b>	Mailflow System® Elevated 7"H Closed-Back Sorter Shelf Capacity: 72 2 columns of 11"W & 4 column 12"W Shelves Size: 72"W x 15"D x 48"H Size (Inside): 70"W x 15"D x 38"H 72 Sorting Pockets 15"D without Plexi Doors - GL	SC7248GL	6,545.00	6,545.00	1	332	-	-	-
	Mailflow System® Elevated 15"H Closed-Back Sorter Shelf Capacity: 60 2 columns of 11"W & 4 column 12"W Shelves Size: 72"W x 15"D x 48"H Size (Inside): 70"W x 15"D x 30"H 60 Sorting Pockets 15"D without Plexi Doors - GH	SC7248GH	6,290.00	6,290.00	1	300	-	-	-

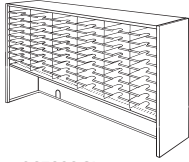

**Note:** All preconfigured models are standard with two columns of 11" wide shelves and the remaining columns with 12" wide shelves. You may receive extra shelves with sorters.

Office Suites  
Seating  
Tables & Desks  
Meeting Essentials  
Personal Organization  
Ergonomics  
High Density Storage  
Storage & Filing  
Facilities  
Technology Furniture  
Art & Engineering  
K-12 Education  
SAFE Collection Addendum

## Open-Back Sorters

Open-Back Sorters are typically used where mail is passed through – sorted on one side and collected by the recipient on the other.

- All sorters are 15" deep with 14" deep sorting shelves. Adjust on 1/2"H increments
- Preconfigured models, designated by the letter "C" are available, or build-your-own and adding components on pages 233-235
- Pricing below is for sorters without doors
- Available in Safco® Corporate Colors see page 10 or go to [Safcoproducts.com](http://Safcoproducts.com) for more information

- For assistance with custom Mailflow Systems configuration contact your local Safco Sales Rep Group.

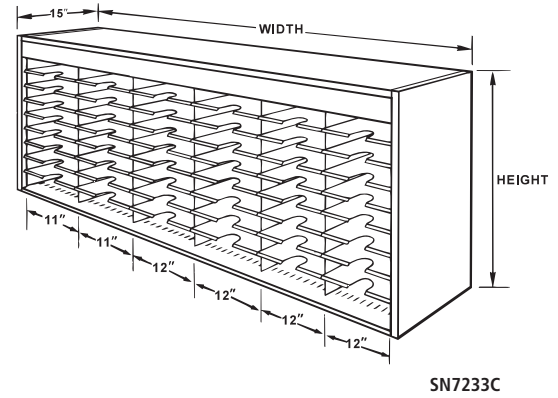

SN7233C

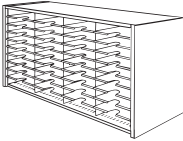
Model #	Description	Model #	List Price Ea.	List Carton Price	Quantity Per Carton	Actual Weight	S-Parcel Billable Weight	Carton Cube	Freight Class
 <p>SN4833C</p>	<b>SN4833</b> Mailflow System® Open-Back Sorter Shelf Capacity: 36 2 columns of 11"W & 2 column 12"W Shelves Size: 48"W x 15"D x 33"H Size (Inside): 46"W x 15"D x 27"H 36 Sorting Pockets 15"D without Plexi Doors - C	SN4833C	3,715.00	3,715.00	1	149	-	-	-
	<b>SN4841</b> Mailflow System® Open-Back Sorter Shelf Capacity: 44 2 columns of 11"W & 2 column 12"W Shelves Size: 48"W x 15"D x 41"H Size (Inside): 49"W x 15"D x 35"H 44 Sorting Pockets 15"D without Plexi Doors - C	SN4841C	4,321.00	4,321.00	1	181	-	-	-
	<b>SN4848</b> Mailflow System® Open-Back Sorter Shelf Capacity: 56 2 columns of 11"W & 2 column 12"W Shelves Size: 48"W x 15"D x 48"H Size (Inside): 46"W x 15"D x 42"H 56 Sorting Pockets 15"D without Plexi Doors - C	SN4848C	5,060.00	5,060.00	1	213	-	-	-

**Note:** All preconfigured models are standard with two columns of 11" wide shelves and the remaining columns with 12" wide shelves. You may receive extra shelves with sorters.

# Mailflow Systems® - Open-Back Sorters

Safco® Products marketing materials are designed to be used as sales tools for our Dealer network.

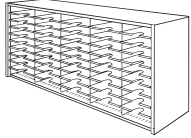
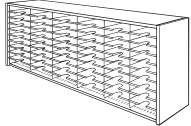
Model #	Description	Model #	List Price Ea.	List Carton Price	Quantity Per Carton	Actual Weight	S-Parcel Billable Weight	Carton Cube	Freight Class
 SN6033C	<b>SN6033</b> Mailflow System® Open-Back Sorter Shelf Capacity: 45 2 columns of 11"W & 3 column 12"W Shelves Size: 60"W x 15"D x 33"H Size (Inside): 58"W x 15"D x 27"H 45 Sorting Pockets 15"D without Plexi Doors- C	SN6033C	4,386.00	4,386.00	1	188	-	-	-
	<b>SN6041</b> Mailflow System® Open-Back Sorter Shelf Capacity: 55 2 columns of 11"W & 3 column 12"W Shelves Size: 60"W x 15"D x 41"H Size (Inside): 58"W x 15"D x 35"H 55 Sorting Pockets 15"D without Plexi Doors- C	SN6041C	4,932.00	4,932.00	1	238	-	-	-
	<b>SN6048</b> Mailflow System® Open-Back Sorter Shelf Capacity: 70 2 columns of 11"W & 3 column 12"W Shelves Size: 60"W x 15"D x 48"H Size (Inside): 58"W x 15"D x 42"H 70 Sorting Pockets 15"D without Plexi Doors- C	SN6048C	6,031.00	6,031.00	1	285	-	-	-
 SN7233C	<b>SN7233</b> Mailflow System® Open-Back Sorter Shelf Capacity: 54 2 columns of 11"W & 4 column 12"W Shelves Size: 72"W x 15"D x 33"H Size (Inside): 70"W x 15"D x 27"H 54 Sorting Pockets 15"D without Plexi Doors- C	SN7233C	4,919.00	4,919.00	1	232	-	-	-
	<b>SN7241</b> Mailflow System® Open-Back Sorter Shelf Capacity: 66 2 columns of 11"W & 4 column 12"W Shelves Size: 72"W x 15"D x 41"H Size (Inside): 70"W x 15"D x 35"H 66 Sorting Pockets 15"D without Plexi Doors- C	SN7241C	5,791.00	5,791.00	1	282	-	-	-
	<b>SN7248</b> Mailflow System® Open-Back Sorter Shelf Capacity: 84 2 columns of 11"W & 4 column 12"W Shelves Size: 72"W x 15"D x 48"H Size (Inside): 70"W x 15"D x 42"H 84 Sorting Pockets 15"D without Plexi Doors- C	SN7248C	6,924.00	6,924.00	1	331	-	-	-

**Note:** All preconfigured models are standard with two columns of 11" wide shelves and the remaining columns with 12" wide shelves. You may receive extra shelves with sorters.

Open-Back Sorters are typically used where mail is passed through – sorted on one side and collected by the recipient on the other

- All sorters are 15" deep with 14" deep sorting shelves. Adjust on 1/2"H increments
  - Preconfigured models, designated by the letter "C" are available, or build-your-own and adding components on pages 233-235
  - Elevated sorters offer more workspace, by raising the sorter off the work area
  - Pricing below is for sorters without doors
  - Available in Safco® Corporate Colors see page 10 or go to [Safcoproducts.com](http://Safcoproducts.com) for more information
- For assistance with custom Mailflow Systems configuration contact your local Safco Sales Rep Group.

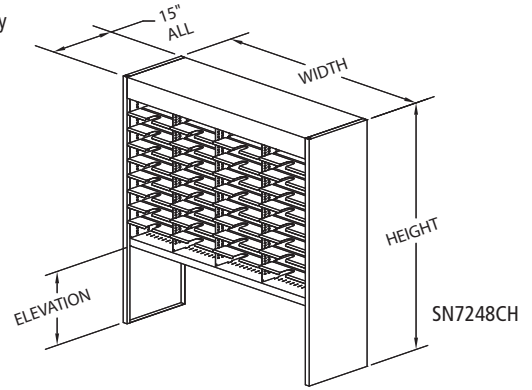

Model #	Description	Model #	List Price Ea.	List Carton Price	Quantity Per Carton	Actual Weight	S-Parcel Billable Weight	Carton Cube	Freight Class
<b>SN4833</b>	Mailflow System® Elevated 9"H Open-Back Sorter Shelf Capacity: 24 2 columns of 11"W & 2 column 12"W Shelves Size: 48"W x 15"D x 33"H Size (Inside): 46"W x 15"D x 18"H 24 Sorting Pockets 15"D without Plexi Doors- CL	SN4833CL	3,280.00	3,280.00	1	103	-	-	-
<b>SN4841</b>	Mailflow System® Elevated 8"H Open-Back Sorter Shelf Capacity: 36 2 columns of 11"W & 2 column 12"W Shelves Size: 48"W x 15"D x 41"H Size (Inside): 46"W x 15"D x 27"H 36 Sorting Pockets 15"D without Plexi Doors- CL	SN4841CL	3,958.00	3,958.00	1	132	-	-	-
<b>SN4841CH</b>	Mailflow System® Elevated 17"H Open-Back Sorter Shelf Capacity: 24 2 columns of 11"W & 2 column 12"W Shelves Size: 48"W x 15"D x 41"H Size (Inside): 46"W x 15"D x 18"H 24 Sorting Pockets 15"D without Plexi Doors- CH	SN4841CH	3,707.00	3,707.00	1	108	-	-	-
<b>SN4848</b>	Mailflow System® Elevated 7"H Open-Back Sorter Shelf Capacity: 44 2 columns of 11"W & 2 column 12"W Shelves Size: 48"W x 15"D x 48"H Size (Inside): 46"W x 15"D x 35"H 44 Sorting Pockets 15"D without Plexi Doors- C	SN4848CL	4,748.00	4,748.00	1	153	-	-	-
<b>SN4848CH</b>	Mailflow System® Elevated 15"H Open-Back Sorter Shelf Capacity: 36 2 columns of 11"W & 2 column 12"W Shelves Size: 48"W x 15"D x 48"H Size (Inside): 46"W x 15"D x 27"H 36 Sorting Pockets 15"D without Plexi Doors- CH	SN4848CH	4,243.00	4,243.00	1	137	-	-	-



**Note:** All preconfigured models are standard with two columns of 11" wide shelves and the remaining columns with 12" wide shelves. You may receive extra shelves with sorters.

Office Suites  
Seating  
Tables & Desks  
Meeting Essentials  
Personal Organization  
Ergonomics  
High Density Storage  
Storage & Filing  
Facilities  
Technology Furniture  
Art & Engineering  
K-12 Education  
SAFE Collection Addendum

# Mailflow Systems® - Elevated Open-Back Sorters

Safco® Products marketing materials are designed to be used as sales tools for our Dealer network.

Model #	Description	Model #	List Price Ea.	List Carton Price	Quantity Per Carton	Actual Weight	S-Parcel Billable Weight	Carton Cube	Freight Class
<b>SN6033</b>	Mailflow System® Elevated 9"H Open-Back Sorter Shelf Capacity: 30 2 columns of 11"W & 3 column 12"W Shelves Size: 60"W x 15"D x 33"H Size (Inside): 58"W x 15"D x 18"H 30 Sorting Pockets 15"D without Plexi Doors- CL	SN6033CL	3,727.00	3,727.00	1	135	-	-	-
<b>SN6041</b>	Mailflow System® Elevated 8"H Open-Back Sorter Shelf Capacity: 45 2 columns of 11"W & 3 column 12"W Shelves Size: 60"W x 15"D x 41"H Size (Inside): 58"W x 15"D x 27"H 45 Sorting Pockets 15"D without Plexi Doors- CL	SN6041CL	4,650.00	4,650.00	1	170	-	-	-
<b>SN6033CL</b>	Mailflow System® Elevated 17"H Open-Back Sorter Shelf Capacity: 30 2 columns of 11"W & 3 column 12"W Shelves Size: 60"W x 15"D x 41"H Size (Inside): 58"W x 15"D x 18"H 30 Sorting Pockets 15"D without Plexi Doors- CH	SN6041CH	4,171.00	4,171.00	1	140	-	-	-
<b>SN6048</b>	Mailflow System® Elevated 7"H Open-Back Sorter Shelf Capacity: 55 2 columns of 11"W & 3 column 12"W Shelves Size: 60"W x 15"D x 48"H Size (Inside): 58"W x 15"D x 35"H 55 Sorting Pockets 15"D without Plexi Doors- CL	SN6048CL	5,103.00	5,103.00	1	195	-	-	-
	Mailflow System® Elevated 15"H Open-Back Sorter Shelf Capacity: 45 2 columns of 11"W & 3 column 12"W Shelves Size: 60"W x 15"D x 48"H Size (Inside): 58"W x 15"D x 27"H 45 Sorting Pockets 15"D without Plexi Doors- CH	SN6048CH	5,182.00	5,182.00	1	175	-	-	-
<b>SN7233</b>	Mailflow System® Elevated 9"H Open-Back Sorter Shelf Capacity: 36 2 columns of 11"W & 4 column 12"W Shelves Size: 72"W x 15"D x 33"H Size (Inside): 70"W x 15"D x 18"H 36 Sorting Pockets 15"D without Plexi Doors- CL	SN7233CL	4,401.00	4,401.00	1	164	-	-	-
<b>SN7241</b>	Mailflow System® Elevated 8"H Open-Back Sorter Shelf Capacity: 54 2 columns of 11"W & 4 column 12"W Shelves Size: 72"W x 15"D x 41"H Size (Inside): 70"W x 15"D x 27"H 54 Sorting Pockets 15"D without Plexi Doors- CL	SN7241CL	5,484.00	5,484.00	1	213	-	-	-
	Mailflow System® Elevated 17"H Open-Back Sorter Shelf Capacity: 36 2 columns of 11"W & 4 column 12"W Shelves Size: 72"W x 15"D x 41"H Size (Inside): 70"W x 15"D x 18"H 36 Sorting Pockets 15"D without Plexi Doors- CH	SN7241CH	4,960.00	4,960.00	1	177	-	-	-

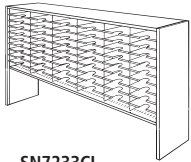

**Note:** All preconfigured models are standard with two columns of 11" wide shelves and the remaining columns with 12" wide shelves. You may receive extra shelves with sorters.

## Mailflow Systems® - Elevated Open-Back Sorters

Model #	Description	Model #	List Price Ea.	List Carton Price	Quantity Per Carton	Actual Weight	S-Parcel Billable Weight	Carton Cube	Freight Class
SN7248	Mailflow System® Elevated 7"H Open-Back Sorter Shelf Capacity: 66 2 columns of 11"W & 4 column 12"W Shelves Size: 72"W x 15"D x 48"H Size (Inside): 70"W x 15"D x 35"H 66 Sorting Pockets 15"D without Plexi Doors- CL	SN7248CL	5,859.00	5,859.00	1	247	-	-	-
	Mailflow System® Elevated 15"H Open-Back Sorter Shelf Capacity: 54 2 columns of 11"W & 4 column 12"W Shelves Size: 72"W x 15"D x 48"H Size (Inside): 70"W x 15"D x 27"H 54 Sorting Pockets 15"D without Plexi Doors- CH	SN7248CH	5,640.00	5,640.00	1	223	-	-	-

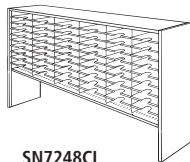

SN7248CL

**Note:** All preconfigured models are standard with two columns of 11" wide shelves and the remaining columns with 12" wide shelves. You may receive extra shelves with sorters.

## Work Surface Finishes – High Pressure Laminate

Designer White  
Biltmore Cherry  
Columbian Walnut  
Fashion Gray

Fusion Maple  
Black  
Asian Night  
Asian Sand

## High-Pressure Laminate Edge Band Colors

Black, Designer White, Ice Gray

## Safco® Corporate Color Program – Powder Coat Paint Finishes

Black  
Blue Medium  
Desert Sage

Mist  
Navy  
Tech Silver

White  
Textured Graphite  
Textured Gray

Textured Black

## Custom Request Form see page 11

All requests for customization of product, sizes and finishes must have prior approval. Please email [specials@safcoproducts.com](mailto:specials@safcoproducts.com)

Contact your local Safco Sales Rep Group to discuss space planning specific application, obtain prior approval and quote.

### TO ORDER, PLEASE SPECIFY:

Example: **S A 3 6 8 0 G 1** + **B L A C K** + **B L A C K** + **D E S E R T S A G E**

MODEL HIGH PRESSURE LAMINATE COLOR EDGE BAND COLOR CABINET POWDER COAT FINISH

WHEN ORDERING HIGH PRESSURE LAMINATE ADD SUFFIX "LAM"

Model #	Description	Laminates	List Price Ea.	Carton Price	Quantity Per Carton	Actual Weight	S-Parcel Billable Weight	Carton Cube	Freight Class
	<ul style="list-style-type: none"> <li>Steel back panel has one 3" diameter cable management cutout</li> <li>Shelves and work surface adjust on 1/2" H increments</li> </ul>								
	<ul style="list-style-type: none"> <li>All-welded steel cabinet construction</li> </ul>								
<b>Satellite Sorter - 36"W x 80"H x 16"D</b>									
<b>SA3680G1</b>	Satellite Sorter, Shelf: 15"D, 30 Pocket 2 columns of 11"W & 1 column 12"W Shelves Work Surface: 33 1/2"W x 27"D x 1"H	SA3680G1LAM -	6,216.00	6,216.00	1	240	-	-	-
<b>SA3680L1</b>	Satellite Sorter, Shelf: 12"D, 30 Pocket 2 columns of 11"W & 1 column 12"W Shelves Work Surface: 33 1/2"W x 27"D x 1"H	SA3680L1LAM	5,881.00	5,881.00	1	222	-	-	-

## Mailflow Systems® - Specialized Freestanding Sorters

- Preconfigured models come standard with 3" H pockets in either letter (12"D) or legal (15"D) depths. Adjust on 1/2" H increments
- All-welded steel cabinet construction

### Specialized Freestanding Sorters - 36"W, 2 columns of 11"W & 1 column 12"W Shelves

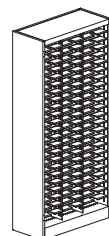
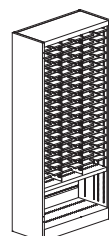
	<b>SF3665B</b>	Mailflow System® Freestanding Sorter Shelf Capacity: 57 Size: 36"W x 12"D x 64 1/2"H - Letter-Size - BL1 Size: 36"W x 15"D x 64 1/2"H - Legal-Size - BG1	SF3665BL1 SF3665BG1	5,431.00 5,988.00	5,431.00 5,988.00	1 1	292 273	- -	- -	- -
	<b>SF3680B</b>	Mailflow System® Freestanding Sorter Shelf Capacity: 72 Size: 36"W x 12"D x 80"H - Letter-Size - BL1 Size: 36"W x 15"D x 80"H - Legal-Size - BG1	SF3680BL1 SF3680BG1	6,358.00 6,873.00	6,358.00 6,873.00	1 1	414 444	- -	- -	- -
	<b>SF3665D</b>	Mailflow System® Freestanding Sorter Shelf Capacity: 45 Size: 36"W x 12"D x 64 1/2"H - Letter-Size-DL1 Size: 36"W x 15"D x 64 1/2"H - Legal-Size-DG1	SF3665DL1 SF3665DG1	5,057.00 5,517.00	5,057.00 5,517.00	1 1	292 273	- -	- -	- -
	<b>SF3680D</b>	Mailflow System® Freestanding Sorter Shelf Capacity: 57 Size: 36"W x 12"D x 80"H - Letter-Size - DL1 Size: 36"W x 15"D x 80"H - Legal-Size - DG1	SF3680DL1 SF3680DG1	6,016.00 6,427.00	6,016.00 6,427.00	1 1	414 444	- -	- -	- -

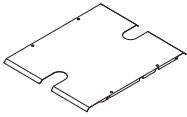
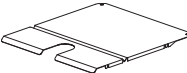
Model #	Description	Model #	List Price Ea.	Carton Price	Quantity Per Carton	Actual Weight	S-Parcel Billable Weight	Carton Cube	Freight Class
<ul style="list-style-type: none"> <li>• All shelves lock in place and won't pull out when retrieving mail</li> <li>• Shelves can be removed for easy height adjustment on 1/2" increments</li> <li>• Shelves have centered thumb cut for quick, one-handed retrieval</li> </ul>		<ul style="list-style-type: none"> <li>• Front edge of shelves has a 45° beveled labeling flange for easy reading of labels and allows mail from pocket below to pass under above shelf without hanging up</li> <li>• Heavy-duty, 20-gauge shelves with V-groove hold up to 75 lbs. per pocket</li> </ul>							
		<b>Kwik-Shelf™ Shelving System for Open-Back Sorters, Plexi Door Units</b>							
1114P06	Shelf for Open-Back Sorter Shelf: 11"W x 14 1/2"D	1114P06	255.00	255.00	6	2	-	-	-
1214P06	Shelf for Open-Back Sorter Shelf: 12"W x 14 1/2"D	1214P06	259.00	259.00	6	2.5	-	-	-
		<b>Kwik-Shelf™ Shelving System for Non-Plexi Door, Closed-Back Sorters</b>							
0412P06	Shelf for Closed-Back Sorter Shelf: 4"W x 12"D	0412P06	139.00	139.00	6	0.5	-	-	-
0512P06	Shelf for Closed-Back Sorter Shelf: 5"W x 12"D	0512P06	149.00	149.00	6	0.75	-	-	-
0515P06	Shelf for Closed-Back Sorter Shelf: 5"W x 15"D	0515P06	155.00	155.00	6	1	-	-	-
0612P06	Shelf for Closed-Back Sorter Shelf: 6"W x 12"D	0612P06	154.00	154.00	6	0.75	-	-	-
0712P06	Shelf for Closed-Back Sorter Shelf: 7"W x 12"D	0712P06	162.00	162.00	6	1	-	-	-
0812P06	Shelf for Closed-Back Sorter Shelf: 8"W x 12"D	0812P06	191.00	191.00	6	1.05	-	-	-
0912P06	Shelf for Closed-Back Sorter Shelf: 9"W x 12"D	0912P06	210.00	210.00	6	1.05	-	-	-
0915P06	Shelf for Closed-Back Sorter Shelf: 9"W x 15"D	0915P06	238.00	238.00	6	2	-	-	-
1012P06	Shelf for Closed-Back Sorter Shelf: 10"W x 12"D	1012P06	222.00	222.00	6	1.15	-	-	-
1015P06	Shelf for Closed-Back Sorter Shelf: 10"W x 15"D	1015P06	254.00	254.00	6	1.5	-	-	-
1112P06	Shelf for Closed-Back Sorter Shelf: 11"W x 12"D	1112P06	235.00	235.00	6	1.25	-	-	-
1115P06	Shelf for Closed-Back Sorter Shelf: 11"W x 15"D	1115P06	255.00	255.00	6	1.75	-	-	-
1212P06	Shelf for Closed-Back Sorter Shelf: 12"W x 12"D	1212P06	238.00	238.00	6	1.4	-	-	-
1215P06	Shelf for Closed-Back Sorter Shelf: 12"W x 15"D	1215P06	267.00	267.00	6	1.75	-	-	-
1412P06	Shelf for Closed-Back Sorter Shelf: 14"W x 12"D	1412P06	326.00	326.00	6	2.3	-	-	-
1415P06	Shelf for Closed-Back Sorter Shelf: 14"W x 15"D	1415P06	353.00	353.00	6	2.75	-	-	-
1515P06	Shelf for Closed-Back Sorter Shelf: 15"W x 15"D	1515P06	394.00	394.00	6	2.9	-	-	-
1612P06	Shelf for Closed-Back Sorter Shelf: 16"W x 12"D	1612P06	376.00	376.00	6	2.8	-	-	-
1615P06	Shelf for Closed-Back Sorter Shelf: 16"W x 15"D	1615P06	412.00	412.00	6	3	-	-	-

Office Suites  
Seating  
Tables & Desks  
Meeting Essentials  
Personal Organization  
Ergonomics  
High Density Storage  
Storage & Filing  
Facilities  
Technology Furniture  
Art & Engineering  
K-12 Education  
SAFE Collection Addendum



# Mailflow Systems® - Shelf Support

Safco® Products marketing materials are designed to be used as sales tools for our Dealer network.

Model #	Description	Model #	List Price Ea.	Carton Price	Quantity Per Carton	Actual Weight	S-Parcel Billable Weight	Carton Cube	Freight Class
---------	-------------	---------	----------------	--------------	---------------------	---------------	--------------------------	-------------	---------------

Shelf Supports divide a sorter into columns and support the shelves within each column.

- Shelf supports are adjustable in 1" horizontal increments to fit various shelf widths
- Each support is slotted at 1/2" vertical increments for shelf adjustment
- Shelf support models are based on sorter type, height and shelf depth
- When ordering, remember that the two end shelf supports are included with each sorter

### Shelf Support - Closed-Back Sorters

	<b>SS24LM0</b> Shelf Support - 21"H Size: 12"W x 21"H	SS24LM01	81.00	81.00	1 Unit	5.4	-	-	-
		SS24LM02	160.00	160.00	2 Unit	5.4	-	-	-
		SS24LM03	243.00	243.00	3 Unit	5.4	-	-	-
		SS24LM04	321.00	321.00	4 Unit	5.4	-	-	-
		SS24LM05	407.00	407.00	5 Unit	5.4	-	-	-
	<b>SS24GM0</b> Shelf Support - 21"H Size: 15"W x 21"H	SS24GM01	99.00	99.00	1 Unit	8.4	-	-	-
		SS24GM02	194.00	194.00	2 Unit	8.4	-	-	-
		SS24GM03	298.00	298.00	3 Unit	8.4	-	-	-
		SS24GM04	404.00	404.00	4 Unit	8.4	-	-	-
		SS24GM05	498.00	498.00	5 Unit	8.4	-	-	-
	<b>SS33LM0</b> Shelf Support - 30"H Size: 12"W x 30"H	SS33LM01	91.00	91.00	1 Unit	8.0	-	-	-
		SS33LM02	189.00	189.00	2 Unit	8.0	-	-	-
		SS33LM03	291.00	291.00	3 Unit	8.0	-	-	-
		SS33LM04	393.00	393.00	4 Unit	8.0	-	-	-
		SS33LM05	480.00	480.00	5 Unit	8.0	-	-	-
<b>SS33GM0</b> Shelf Support - 30"H Size: 15"W x 30"H	SS33GM01	117.00	117.00	1 Unit	10.5	-	-	-	
	SS33GM02	235.00	235.00	2 Unit	10.5	-	-	-	
	SS33GM03	340.00	340.00	3 Unit	10.5	-	-	-	
	SS33GM04	455.00	455.00	4 Unit	10.5	-	-	-	
	SS33GM05	560.00	560.00	5 Unit	10.5	-	-	-	
<b>SS41LM0</b> Shelf Support - 38"H Size: 12"W x 38"H	SS41LM01	113.00	113.00	1 Unit	9.5	-	-	-	
	SS41LM02	229.00	229.00	2 Unit	9.5	-	-	-	
	SS41LM03	340.00	340.00	3 Unit	9.5	-	-	-	
	SS41LM04	469.00	469.00	4 Unit	9.5	-	-	-	
	SS41LM05	577.00	577.00	5 Unit	9.5	-	-	-	
<b>SS41GM0</b> Shelf Support - 38"H Size: 15"W x 38"H	SS41GM01	131.00	131.00	1 Unit	12.6	-	-	-	
	SS41GM02	271.00	271.00	2 Unit	12.6	-	-	-	
	SS41GM03	395.00	395.00	3 Unit	12.6	-	-	-	
	SS41GM04	538.00	538.00	4 Unit	12.6	-	-	-	
	SS41GM05	678.00	678.00	5 Unit	12.6	-	-	-	
<b>SS48LM0</b> Shelf Support - 45"H Size: 12"W x 45"H	SS48LM01	131.00	131.00	1 Unit	11.0	-	-	-	
	SS48LM02	279.00	279.00	2 Unit	11.0	-	-	-	
	SS48LM03	407.00	407.00	3 Unit	11.0	-	-	-	
	SS48LM04	522.00	522.00	4 Unit	11.0	-	-	-	
	SS48LM05	678.00	678.00	5 Unit	11.0	-	-	-	
<b>SS48GM0</b> Shelf Support - 45"H Size: 15"W x 45"H	SS48GM01	159.00	159.00	1 Unit	14.8	-	-	-	
	SS48GM02	301.00	301.00	2 Unit	14.8	-	-	-	
	SS48GM03	469.00	469.00	3 Unit	14.8	-	-	-	
	SS48GM04	619.00	619.00	4 Unit	14.8	-	-	-	
	SS48GM05	771.00	771.00	5 Unit	14.8	-	-	-	

### Shelf Support - Open-Back and Plexi Back Sorters

	<b>SS24N0</b> Shelf Support - 21"H Size: 14 1/2"D x 21"H	SS24N01	96.00	96.00	1 Unit	8.0	-	-	-
		SS24N02	200.00	200.00	2 Unit	8.0	-	-	-
		SS24N03	298.00	298.00	3 Unit	8.0	-	-	-
		SS24N04	404.00	404.00	4 Unit	8.0	-	-	-
		SS24N05	498.00	498.00	5 Unit	8.0	-	-	-
	<b>SS33N0</b> Shelf Support - 30"H Size: 14 1/2"D x 30"H	SS33N01	113.00	113.00	1 Unit	10.0	-	-	-
		SS33N02	235.00	235.00	2 Unit	10.0	-	-	-
		SS33N03	340.00	340.00	3 Unit	10.0	-	-	-
		SS33N04	469.00	469.00	4 Unit	10.0	-	-	-
		SS33N05	577.00	577.00	5 Unit	10.0	-	-	-
	<b>SS41N0</b> Shelf Support - 38"H Size: 14 1/2"D x 38"H	SS41N01	131.00	131.00	1 Unit	12.0	-	-	-
		SS41N02	279.00	279.00	2 Unit	12.0	-	-	-
		SS41N03	407.00	407.00	3 Unit	12.0	-	-	-
		SS41N04	538.00	538.00	4 Unit	12.0	-	-	-
		SS41N05	678.00	678.00	5 Unit	12.0	-	-	-
<b>SS48N0</b> Shelf Support - 45"H Size: 14 1/2"D x 45"H	SS48N01	160.00	160.00	1 Unit	14.0	-	-	-	
	SS48N02	325.00	325.00	2 Unit	14.0	-	-	-	
	SS48N03	469.00	469.00	3 Unit	14.0	-	-	-	
	SS48N04	636.00	636.00	4 Unit	14.0	-	-	-	
	SS48N05	795.00	795.00	5 Unit	14.0	-	-	-	

Office Suites  
Seating  
Tables & Desks  
Meeting Essentials  
Personal Organization  
Ergonomics  
High Density Storage  
Storage & Filing  
Facilities  
Technology Furniture  
Art & Engineering  
K-12 Education  
SAFE Collection Addendum

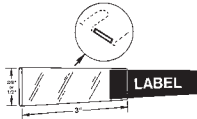
Model #	Description	Model #	List Price Ea.	Carton Price	Quantity Per Carton	Actual Weight	S-Parcel Billable Weight	Carton Cube	Freight Class
<b>Label Holders</b>									
<ul style="list-style-type: none"> <li>• Transparent label holders fit securely on beveled shelf front</li> <li>• Blank, white label inserts with four sides are included</li> </ul>									
90145	Label Holder, Adhesive - 3"W x 3/8"H	90145	49.00	-	20	1 oz.	-	-	-
911785	Label Holder, Magnetic - 3"W x 1/2"H	911785	73.00	-	20	3 oz.	-	-	-
922VEL	Label Holder, Velcro® - 3"W x 1/2"H	922VEL	4.00	-	20	3 oz.	-	-	-
									
90155	Label, Adhesive - Colored - 3"W x 3/8"H	90155	8.40	-	84/set	1 oz.	-	-	-
90154	Label, Adhesive - White - 3"W x 3/8"H	90154	8.40	-					
911884	Label, Magnetic - White - 3"W x 1/2"H	911884	6.00	-					

**90155 - Set of label inserts in six colors** (White, Orange, Blue, Yellow, Pink and Green), in microperforated, 8 1/2" x 11" sheets. 14 four-sided blank label inserts per color, 84 per set. Fit in label holders (above). Use with PC and ink jet or laser printer.

**Work Surface Finishes – High Pressure Laminate**

- |                  |              |
|------------------|--------------|
| Designer White   | Fusion Maple |
| Biltmore Cherry  | Black        |
| Columbian Walnut | Asian Night  |
| Fashion Gray     | Asian Sand   |

**Grommet**

For additional wire management select a grommet. Grommets are located towards the rear and positioned in the center of the table (Black only).

Model #	Suffix	List Price
G	Multi Use Grommet (Black)	28.00

**High Pressure Laminate Edge Band Colors**

Black, Designer White, Ice Gray

**Safco® Corporate Color Program – Powder Coat Paint Finishes**

- |             |             |                   |                |
|-------------|-------------|-------------------|----------------|
| Black       | Mist        | White             | Textured Black |
| Blue Medium | Navy        | Textured Graphite |                |
| Desert Sage | Tech Silver | Textured Gray     |                |

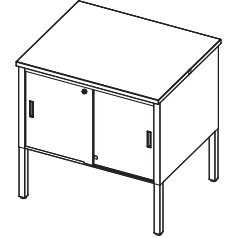

**Custom Request Form see page 11**

All requests for customization of product, sizes and finishes must have prior approval. Please email [specials@safcoproducts.com](mailto:specials@safcoproducts.com)



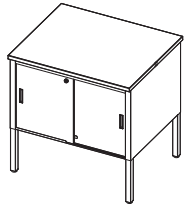

**Order Example: T S A 3 6 3 0 H G + B L A C K + B L A C K + T E C H S I L V E R**  
MODEL LAMINATE FINISH EDGE BAND COLOR CABINET POWDER COAT FINISH

Model #	Description	Laminates	Model #	List Price Ea.	Quantity Carton Price	Per Carton	S-Parcel Actual Weight	Billable Weight	Carton Cube	Freight Class
<b>Storage Tables - No Master Key Available</b> 										
TSA3630H	Storage Table 36"W x 30"D x 24" to 36"H	High Pressure	TSA3630H	3,175.00	3,175.00	1	129	-	-	-
TSA3630DH	Storage Table with Locking Doors 36"W x 30"D x 24" to 36"H	High Pressure	TSA3630DH	3,923.00	3,923.00	1	146	-	-	-
TSA4830H	Storage Table 48"W x 30"D x 24" to 36"H	High Pressure	TSA4830H	3,471.00	3,471.00	1	155	-	-	-
TSA4830DH	Storage Table with Locking Doors 48"W x 30"D x 24" to 36"H	High Pressure	TSA4830DH	4,356.00	4,356.00	1	172	-	-	-
TSA6030H	Storage Table 60"W x 30"D x 24" to 36"H	High Pressure	TSA6030H	3,905.00	3,905.00	1	180	-	-	-
TSA6030DH	Storage Table with Locking Doors 60"W x 30"D x 24" to 36"H	High Pressure	TSA6030DH	4,835.00	4,835.00	1	198	-	-	-
TSA7230H	Storage Table 72"W x 30"D x 24" to 36"H	High Pressure	TSA7230H	4,366.00	4,366.00	1	230	-	-	-
TSA7230DH	Storage Table with Locking Doors 72"W x 30"D x 24" to 36"H	High Pressure	TSA7230DH	5,349.00	5,349.00	1	250	-	-	-

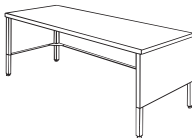

Office Suites  
Seating  
Tables & Desks  
Meeting Essentials  
Personal Organization  
Ergonomics  
High Density Storage  
Storage & Filing  
Facilities  
Technology Furniture  
Art & Engineering  
K-12 Education  
SAFE Collection Addendum

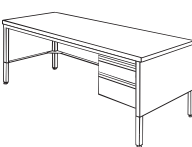
## Mailflow Systems® - Tables & Storage Tables

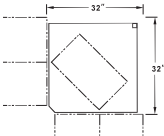
Model #	Description	Laminates	Model #	List Price Ea.	Quantity Carton Price	Per Carton	S-Parcel Actual Weight	Billable Weight	Carton Cube	Freight Class
<b>Work Tables</b>										
	<b>TW30LAM</b> Work Table 30"W x 30"D x 24" to 36"H	High Pressure	TW30LAM	2,151.00	2,151.00	1	66	-	-	-
	<b>TW36LAM</b> Work Table 36"W x 30"D x 24" to 36"H	High Pressure	TW36LAM	2,551.00	2,551.00	1	76	-	-	-
	<b>TW48LAM</b> Work Table 48"W x 30"D x 24" to 36"H	High Pressure	TW48LAM	2,776.00	2,776.00	1	94	-	-	-
	<b>TW72LAM</b> Work Table 72"W x 30"D x 24" to 36"H	 High Pressure	TW72LAM	3,621.00	3,621.00	1	150	-	-	-
<b>Pedestal Tables</b>										
	<b>TP48LAM</b> Pedestal Table 48"W x 30"D x 24" to 36"H	High Pressure	TP48LAM	4,118.00	4,118.00	1	138	-	-	-
	<b>TP60LAM</b> Pedestal Table 60"W x 30"D x 24" to 36"H	High Pressure	TP60LAM	4,658.00	4,658.00	1	166	-	-	-
	<b>TP72LAM</b> Pedestal Table 72"W x 30"D x 24" to 36"H	High Pressure	TP72LAM	5,653.00	5,653.00	1	194	-	-	-
	<b>APED1</b> Suspended Pedestal 1 Box and 1 File Drawer 15 1/4"W x 21 3/4"D x 19 3/4"H		APED1	1,505.00	1,505.00	1	48	-	-	-
	<b>Corner Platform</b> <b>Only can use on Work Tables</b> <b>TCNRLAM</b> Corner Platform 30"W x 30"D x 24" to 36"H (Fits in 32"W x 32"D Space)	High Pressure	TCNRLAM	1,780.00	1,780.00	1	40	-	-	-

## Mailflow Systems® - Storage Consoles

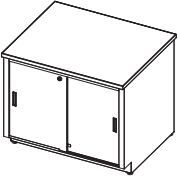
<b>Storage Consoles - No Master Key Available</b>										
	<b>MC363030H</b> Storage Console 36"W x 30"D x 30"H	High Pressure	MC363030H	3,283.00	3,283.00	1	126	-	-	-
	<b>MC363030DH</b> Storage Console with Locking Doors 36"W x 30"D x 30"H	High Pressure	MC363030DH	4,157.00	4,157.00	1	141	-	-	-
	<b>MC483030H</b> Storage Console 48"W x 30"D x 30"H	High Pressure	MC483030H	3,752.00	3,752.00	1	155	-	-	-
	<b>MC483030DH</b> Storage Console with Locking Doors 48"W x 30"D x 30"H	High Pressure	MC483030DH	4,702.00	4,702.00	1	172	-	-	-
	<b>MC603030H</b> Storage Console 60"W x 30"D x 30"H	High Pressure	MC603030H	3,874.00	3,874.00	1	184	-	-	-
	<b>MC603030DH</b> Storage Console with Locking Doors 60"W x 30"D x 30"H	High Pressure	MC603030DH	4,977.00	4,977.00	1	203	-	-	-
	<b>MC723030H</b> Storage Console 72"W x 30"D x 30"H	High Pressure	MC723030H	4,321.00	4,321.00	1	213	-	-	-
	<b>MC723030DH</b> Storage Console with Locking Doors 72"W x 30"D x 30"H	High Pressure	MC723030DH	5,513.00	5,513.00	1	234	-	-	-

Office Suites  
Seating  
Tables & Desks  
Meeting Essentials  
Personal Organization  
Ergonomics  
High Density Storage  
Storage & Filing  
Facilities  
Technology Furniture  
Art & Engineering  
K-12 Education  
SAFE Collection Addendum

# Mailflow Systems® - Adjustable Shelf Kits

Safco® Products marketing materials are designed to be used as sales tools for our Dealer network.

## Work Surface Finishes – High Pressure Laminate

Designer White	Fusion Maple
Biltmore Cherry	Black
Columbian Walnut	Asian Night
Fashion Gray	Asian Sand

### Grommet

For additional wire management select a grommet. Grommets are located towards the rear and positioned in the center of the table (Black only).

Model #	Suffix	List Price
G	Multi-Use Grommet (Black)	28.00

## High Pressure Laminate Edge Band Colors

Black, Designer White, Ice Gray

## Safco® Corporate Color Program – Powder Coat Paint Finishes

Black	Mist	White	Textured Black
Blue Medium	Navy	Textured Graphite	
Desert Sage	Tech Silver	Textured Gray	

## Custom Request Form see page 11

All requests for customization of product, sizes and finishes must have prior approval. Please email [specials@safcoproducts.com](mailto:specials@safcoproducts.com)

**Order Example: C L 4 8 T L A M G + B L A C K + B L A C K + T E C H S I L V E R**



MODEL
LAMINATE FINISH
EDGE BAND COLOR
POWDER COAT FINISH

WHEN ORDERING HIGH PRESSURE LAMINATE ADD SUFFIX "LAM"

Model #	Description	Laminates	Model #	List Price Ea.	Carton Price	Quantity Per Carton	S-Parcel Actual Weight	Billable Weight	Carton Cube	Freight Class
<b>Storage Table &amp; Console Adjustable Shelf Kit</b>										
	<b>TSK3630</b> Adjustable Shelf Kit, 32 $\frac{1}{2}$ "W x 24"D, Graphite	TSK3630		411.00	411.00	1	20	--	--	--
	<b>TSK4830</b> Adjustable Shelf Kit, 44 $\frac{1}{2}$ "W x 24"D, Graphite	TSK4830		449.00	449.00	1	27	--	--	--
	<b>TSK6030</b> Adjustable Shelf Kit, 56 $\frac{1}{2}$ "W x 24"D, Graphite	TSK6030		475.00	475.00	1	33	--	--	--
	<b>TSK7230</b> Adjustable Shelf Kit, 68 $\frac{1}{2}$ "W x 24"D, Graphite	TSK7230		504.00	504.00	1	40	--	--	--

Note: 24"D shelf can only be used with the 30"D Storage Table and Sliding Door Console.

## Mailflow Systems® - Mailroom Table Accessories

Model #	Description	Laminates	Model #	List Price Ea.	Carton Price	Quantity Per Carton	S-Parcel Actual Weight	Billable Weight	Carton Cube	Freight Class
	<b>Pencil Drawer</b> - Store pencils, other small objects. Mounts to any table without doors; field installed. Black only.									
<b>1218</b>	Pencil Drawer 24"W x 16"D x 1 $\frac{3}{4}$ "H		1218	226.00	226.00	1	7	--	--	--
	<b>Table Casters</b> - Heavy-duty Casters with braking action; add mobility to any mail room table.									
<b>ACASTK</b>	6"H Table Casters, Set of 4, field-installed Weight rating 500 lbs. per set of four		ACASTK	617.00	617.00	1	6.5	--	--	--

Build-your-own shipping system with individual frames, shelves, work surfaces and accessories.

- Frames are heavy-duty 11-gauge welded tubular steel
- Frames are slotted on 1" vertical increments allowing components to connect without tools
- Frames can be bolted together as your needs expand. 800 lbs. maximum load per frame
- Shelves are 14-gauge steel with welded attachment brackets
- Work surfaces are of 1" thick thermally-fused low-pressure laminate with medium density wood cores
- Standard finishes: Mist or Sand powder coat paint finish with Birch thermally-fused laminate work surface

Model #	Description	Model #	List Price Ea.	Carton Price	Quantity Per Carton	Actual Weight	S-Parcel Billable Weight	Carton Cube	Freight Class
<b>Steel Frames - 800 lbs. Maximum Load Per Frame</b>									
3202460	Steel Frame, 24"W x 60"H	3202460	942.00	942.00	1	36	-	-	-
3202472	Steel Frame, 24"W x 72"H	3202472	1,011.00	1,011.00	1	40	-	-	-
3202484	Steel Frame, 24"W x 84"H	3202484	1,111.00	1,111.00	1	44	-	-	-
3203060	Steel Frame, 30"W x 60"H	3203060	971.00	971.00	1	39	-	-	-
3203072	Steel Frame, 30"W x 72"H	3203072	1,032.00	1,032.00	1	43	-	-	-
3203084	Steel Frame, 30"W x 84"H	3203084	1,135.00	1,135.00	1	48	-	-	-
3203660	Steel Frame, 24"W x 60"H	3203660	1,004.00	1,004.00	1	40	-	-	-
3203672	Steel Frame, 24"W x 72"H	3203672	1,050.00	1,050.00	1	47	-	-	-
3203684	Steel Frame, 24"W x 84"H	3203684	1,153.00	1,153.00	1	48	-	-	-
<b>Standard finishes:</b> Mist or Sand powder coat paint finish, please specify when ordering									
<b>Leg Options</b>									
350212	Foot, Center Support	350212	143.00	143.00	1	2	-	-	-
350213R	Leg, Single Right	350213R	470.00	470.00	1	13	-	-	-
350213L	Leg, Single Left	350213L	470.00	470.00	1	13	-	-	-
350214	Leg, Double-Sided (Universal)	350214	585.00	585.00	1	11	-	-	-
350215	Casters for Frame (Pair; 1 Locks)	350215	228.00	228.00	1	4	-	-	-
<b>Standard finishes:</b> Mist or Sand powder coat paint finish, please specify when ordering									
<b>Horizontal Mounting Shelf, Steel (Includes Mounting Brackets)</b>									
3302416	Steel Frame, 24"W x 16"D	3302416	343.00	343.00	1	16	-	-	-
3303016	Steel Frame, 30"W x 16"D	3303016	418.00	418.00	1	19	-	-	-
3303616	Steel Frame, 36"W x 16"D	3303616	537.00	537.00	1	20	-	-	-
3304816	Steel Frame, 48"W x 16"D	3304816	780.00	780.00	1	27	-	-	-
3305416	Steel Frame, 54"W x 16"D	3305416	824.00	824.00	1	24	-	-	-
3306016	Steel Frame, 60"W x 16"D	3306016	873.00	873.00	1	32	-	-	-
<b>Standard finishes:</b> Mist or Sand powder coat paint finish, please specify when ordering									
<b>Desk Worksurface (Includes Mounting Brackets)</b>									
3402430	Work Surface, 24"W x 30"D	3402430	808.00	808.00	1	24	-	-	-
3403030	Work Surface, 30"W x 30"D	3403030	916.00	916.00	1	30	-	-	-
3403630	Work Surface, 36"W x 30"D	3403630	1,011.00	1,011.00	1	34	-	-	-
3404830	Work Surface, 48"W x 30"D	3404830	1,209.00	1,209.00	1	45	-	-	-
3406030	Work Surface, 60"W x 30"D	3406030	1,577.00	1,577.00	1	56	-	-	-
3407230	Work Surface, 72"W x 30"D	3407230	1,718.00	1,718.00	1	78	-	-	-
3409030	Work Surface, 90"W x 30"D	3409030	2,177.00	2,177.00	1	96	-	-	-
350220	Adjustable Front Support Leg	350220	304.00	304.00	1	4	-	-	-
<b>Finish:</b> Birch Thermally-Fused laminate work surface									

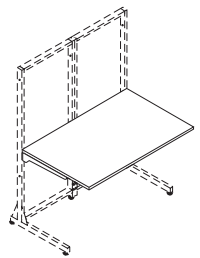
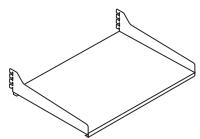
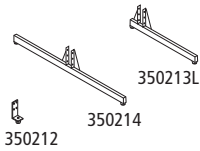
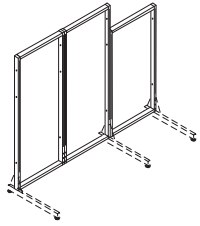

## Mailflow Systems® - Mailroom Accessories

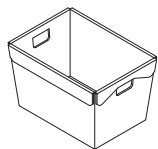

Totes	Description	Model #	List Price Ea.	Carton Price	Quantity Per Carton	Actual Weight	S-Parcel Billable Weight	Carton Cube	Freight Class
90225	Totes, Pack of 3 13¼"W x 18¼"D x 11½"H	90225	294.00	294.00	3	8	-	-	-

Totes of lightweight, high-density polyethylene with 3/8" dia. galvanized wire rod reinforcement at top. Available in packages of 3

# Mailflow-To-Go™ - Work Tables

Safco® Products marketing materials are designed to be used as sales tools for our Dealer network.

The perfect solution for smaller organizations needing economical and functional mail center furniture.

- Rugged steel frame construction with 1" thick thermally-fused low-pressure laminate work surfaces
- 500 lb. weight capacity
- Ready to assemble

## Work Table

- Choice of either a 48"W or a 60"W rectangular table with attaching 30"W corner table
- Corner table has two legs and must be installed adjacent to work table
- Legs are 1½" square, 16-gauge brushed chrome tubular steel
- Tables adjust from 29" - 36" H on 1" increments
- Standard Finishes: Pebble Gray paint with Birch TFL laminate work surface
- Work surfaces have 3mm PVC edge
- 48"W and 60"W table has optional Shelf for under surface storage
- SLF48 and SLF60 each have 75 lb. capacity

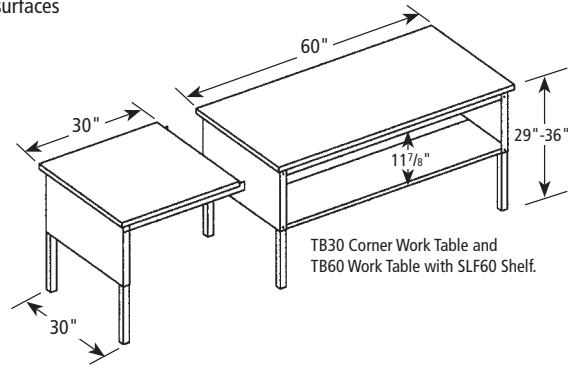

Model #	Description	Model #	List Price Ea.	Carton Price	Quantity Per Carton	Actual Weight	S-Parcel Billable Weight	Carton Cube	Freight Class
<b>Work Tables</b>									
<b>TB48</b>	48"W Work Table 48"W x 30"D x 29-36"H	TB48	1,322.00	1,322.00	1	90	-	-	-
<b>SLF48</b>	Shelf for 48"W Work Table 44"W x 25½"D x 1"H	SLF48	310.00	310.00	1	20	-	-	-
<b>TB60</b>	60"W Work Table 60"W x 30"D x 29-36"H	TB60	1,750.00	1,750.00	1	112	-	-	-
<b>SLF60</b>	Shelf for 60"W Work Table 56"W x 25½"D x 1"H	SLF60	333.00	333.00	1	25	-	-	-
<b>TB30</b>	30"W Corner Work Table 30"W x 30"D x 29-36"H	TB30	1,257.00	1,257.00	1	53	-	-	-
<b>1219</b>	Pencil Tray (Black Only) 21"W x 16"D x 1¼"H	1219	226.00	226.00	1	-	-	-	-

# Mailflow-To-Go™ - Sorters

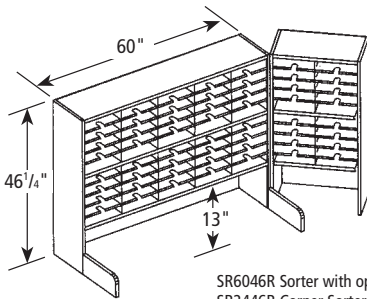

## Sorters

- Standard pocket dimension: 11½"W x 2½"H x 13¼"D. Shelves are fixed
- Pockets sized to accommodate commonly used 10 x 13" flat envelopes
- 48"W and 60"W sorters available in multiple heights, with or without elevated riser
- 24"W sorter available in a two-tier with riser configuration only
- Optional side dump rails and label holders
- Durable steel construction, ready to assemble
- Pebble Gray only

Model #	Description	Model #	List Price Ea.	Carton Price	Quantity Per Carton	Actual Weight	S-Parcel Billable Weight	Carton Cube	Freight Class
<b>Sorters</b>									
<b>SR4833R</b>	1-Tier Riser, 48"W x 13¼"D x 33¼"H - 20 Pockets	SR4833R	1,524.00	1,524.00	1	91	-	-	-
<b>SR4833</b>	2-Tier No Riser, 48"W x 13¼"D x 33¼"H - 40 Pockets	SR4833	1,912.00	1,912.00	1	133	-	-	-
<b>SR4846R</b>	2-Tier Riser, 48"W x 13¼"D x 46¼"H - 40 Pockets	SR4846R	2,366.00	2,366.00	1	146	-	-	-
<b>SR6033R</b>	1-Tier Riser, 60"W x 13¼"D x 33¼"H - 25 Pockets	SR6033R	1,550.00	1,550.00	1	113	-	-	-
<b>SR6033</b>	2-Tier No Riser, 60"W x 13¼"D x 33¼"H - 50 Pockets	SR6033	2,011.00	2,011.00	1	166	-	-	-
<b>SR6046R</b>	2-Tier Riser, 60"W x 13¼"D x 46¼"H - 50 Pockets	SR6046R	2,509.00	2,509.00	1	182	-	-	-
<b>SR2446R</b>	Corner Sorter, 24"W x 13¼"D x 46¼"H - 20 Pockets	SR2446R	1,518.00	1,518.00	1	85	-	-	-
<b>90145</b>	Label Holder (Set of 20) - Adhesive	90145	49.00	-	20	1 oz.	-	-	-
<b>911785</b>	Label Holder (Set of 20) - Magnetic	911785	73.00	-	20	3 oz.	-	-	-
<b>922VEL</b>	Label Holder (Set of 20) - Velcro®	922VEL	4.00	-	20	3 oz.	-	-	-

### Mailflow-To-Go™ Cabinets

These reconfigurable Mailflow-to-Go™ cabinets are a perfect addition to any mail or storage room. Their clever design uses one standard cabinet with any of three internal configurations creating a mail sort station, literature organizer or a standard shelving unit for bulk storage.

- Cabinet measures 42" W x 80" H x 16" D
- Weight capacity 50 lbs. per shelf
- Three unique configurations (Mail, Literature or Bulk Storage)
- Easy to assemble, no hardware required
- Available in Pebble Gray only

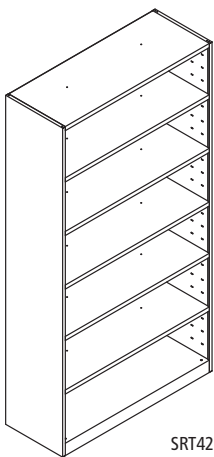

SRT4280A  
(Bulk Storage)

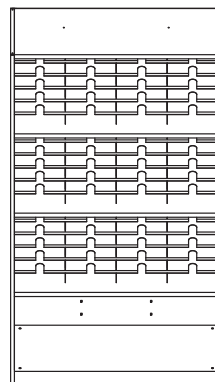

SRT4280B  
(Literature/Form Storage)

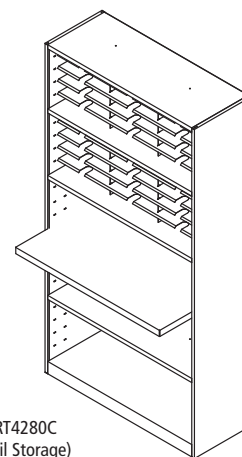

SRT4280C  
(Mail Storage)  
(Note: Reference Shelf 25" D)

Model #	Description	Model #	List Price Ea.	Carton Price	Quantity Per Carton	Actual Weight	S-Parcel Billable Weight	Carton Cube	Freight Class
<b>Cabinets</b>									
SRT4280A	Bulk Storage Cabinet, 5 Adjustable Shelves 42"W x 16"D x 80"H	SRT4280A	2,461.00	2,461.00	1	154	-	-	-
SRT4280B	Storage Cabinet, Literature/Forms, 72 Pockets 42"W x 16"D x 80"H, Pocket Size: 10 1/2"W x 12 3/4"D x 2 1/4"H	SRT4280B	3,890.00	3,890.00	1	234	-	-	-
SRT4280C	Mail Storage Cabinet, 30 Pockets 42"W x 16"D x 80"H, Pocket Size: 13 1/2"W x 12 3/4"D x 2 1/4"H	SRT4280C	3,522.00	3,522.00	1	202	-	-	-

Office Suites  
Seating  
Tables & Desks  
Meeting Essentials  
Personal Organization  
Ergonomics  
High Density Storage  
Storage & Filing  
Facilities  
Technology Furniture  
Art & Engineering  
K-12 Education  
SAFE Collection Addendum



- **Frames:** Heavy-duty 1" x 2" 11-gauge welded steel, slotted on both sides in 1" increments. Frames can be bolted together as needs expand. 800 lb. maximum load per frame. **Note:** Frame heights are for frame only. Must add 3" for foot and 6" for caster and foot. **Note:** Add frame braces #350325 R (RH) and #350325L (LH) for structural rigidity on 72" and 84" height frames
  - **Shelves:** 14-gauge steel with integral attachment brackets. Available either horizontal or with 13° tilt. Floor shelf for CPU requires either glide or caster kit. 300 lb. maximum load per shelf
  - **Work Surface:** 1" Thermally-Fused Fog Gray laminate with T-mold edge standard. Also available in 1/8" high pressure laminate or ESD laminate with T-mold edge (does not include grounding wire) Support brackets included. Additional front support leg suggested for loads over 150 lbs. Support leg included with 36" deep work surfaces
  - **Keyboard supports:** Available in four variations — single wire holder or double wire holder for mounting under steel shelves; retractable platform or keyboard drawer for mounting under work surface
- Available in Safco® Corporate Colors see page 10 or go to [Safcoproducts.com](http://Safcoproducts.com) for more information

## PRECONFIGURED MATRIX® LAN STATION: TYPICALS

Safco offers three preconfigured Maytrix LAN stations to meet a variety of systems needs. **Each ships in a single carton.**  
**Color:** Gray powder coat paint finish, with Fog Gray low pressure laminate surfaces only for preconfigured units.

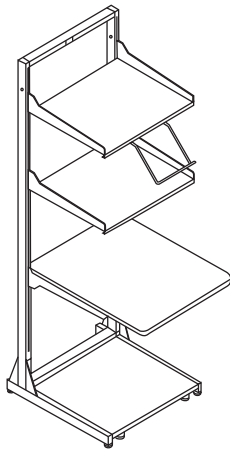

31124

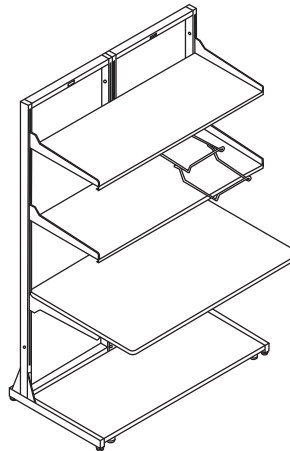

31148

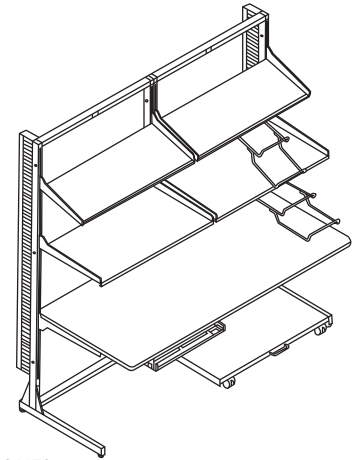

31172

Model No.	Description	Weight	List Price
31124	<b>24" Basic Maytrix</b> (1) 24" x 72" Frame; (2) Single-Sided Legs; (2) 24" x 16" Horizontal Shelves; (1) Single Wire Keyboard Holder; (1) 24" x 30" Work Surface; (1) 18" x 21" Floor Shelf; (1) Floor Shelf Glide Kit	119	3,901.00
31148	<b>48" Maytrix Console</b> (2) 24" x 72" Frames; (2) Single-Sided Legs; (1) Center Support Foot; (2) 48" x 16" Horizontal Shelves; (1) Double Wire Keyboard Holder; (1) 48" x 30" Work Surface; (1) 42" x 21" Floor Shelf; (1) Floor Shelf Glide Kit	211	6,609.00
31172	<b>72" Deluxe Maytrix</b> (2) 36" x 72" frames; (2) Single-Sided Legs; (1) Center Support Foot; (2) 36" x 16" Tilt Shelves; (2) 36" x 16" Horizontal Shelves; (2) Double Wire Keyboard Holders; (1) 72" x 30" Work Surface; (1) Under Surface Keyboard Drawer; (1) 30" x 21" Floor Shelf; (1) Floor Shelf Caster Kit; (2) 6 ft. Slotted Cable Management Channels	270	9,774.00

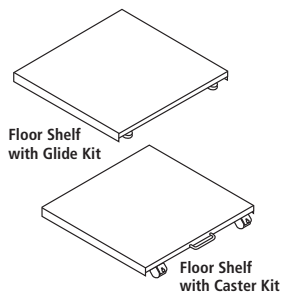
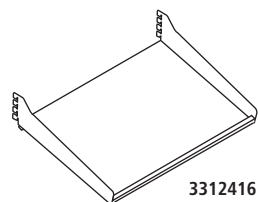
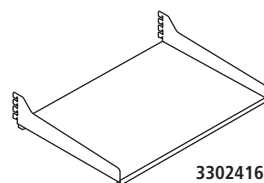
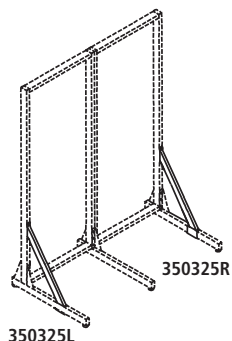
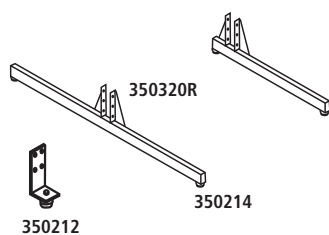
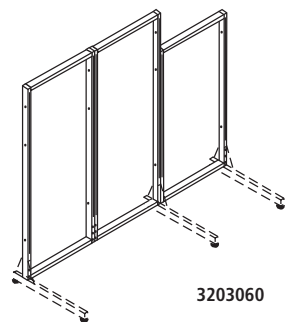

Model No.	Description	Weight	List Price
<b>Maytrix Steel Frames</b>			
3202460	Frame, 24"W x 60"H	36	942.00
3202472	Frame, 24"W x 72"H	40	1,011.00
3202484	Frame, 24"W x 84"H	44	1,111.00
3203060	Frame, 30"W x 60"H	39	971.00
3203072	Frame, 30"W x 72"H	43	1,032.00
3203084	Frame, 30"W x 84"H	48	1,135.00
3203660	Frame, 36"W x 60"H	40	1,004.00
3203672	Frame, 36"W x 72"H	47	1,050.00
3203684	Frame, 36"W x 84"H	48	1,153.00

Model No.	Description	Weight	List Price
<b>Maytrix Leg Options</b>			
350212	Foot, Center Support	2	143.00
350213R	Leg, Single Right (for use with 30" deep work surfaces)	7	470.00
350213L	Leg, Single Left (for use with 30" deep work surfaces)	7	470.00
350320R	Leg, Single Right (for use with 36" deep work surfaces)	7	470.00
350320L	Leg, Single Left (for use with 36" deep work surfaces)	7	470.00
350214	Leg, Double-Sided (universal fits L or R)	11	585.00
350215	Casters for Frame (pair-1 lock, 1 non-lock)	4	228.00
350325R	Frame Brace, Right	4	232.00
350325L	Frame Brace, Left	4	232.00

Model No.	Description	Weight	List Price	Model No.	Description	Weight	List Price
<b>Maytrix Horizontal Mounting Shelf, steel (includes mounting brackets)</b>							
3302416	24"W x 16"D	16	343.00	3302420	24"W x 20"D	16	400.00
3303016	30"W x 16"D	19	418.00	3303020	30"W x 20"D	16	496.00
3303616	36"W x 16"D	20	537.00	3303620	36"W x 20"D	24	564.00
3304816	48"W x 16"D	27	780.00	3304820	48"W x 20"D	27	811.00
3305416	54"W x 16"D	27	824.00	3305420	54"W x 20"D	27	859.00
3306016	60"W x 16"D	32	873.00	3306020	60"W x 20"D	38	920.00
350318	Replacement Center Mounting Bracket (48", 60" only)						161.00

Model No.	Description	Weight	List Price	Model No.	Description	Weight	List Price
<b>Maytrix 13° Tilt Shelf, steel (includes mounting brackets)</b>							
3312416	24"W x 16"D	16	506.00	3312420	24"W x 20"D	19	526.00
3313016	30"W x 16"D	19	593.00	3313020	30"W x 20"D	19	617.00
3313616	36"W x 16"D	21	666.00	3313620	36"W x 20"D	19	695.00

Model No.	Description	Weight	List Price
<b>Maytrix Floor Shelf, steel</b>			
3322421	Floor Shelf, 18"W x 21"D, Fits 24"W Frame	14	596.00
3323021	Floor Shelf, 24"W x 21"D, Fits 30"W Frame	16	593.00
3323621	Floor Shelf, 30"W x 21"D, Fits 36"W Frame	19	604.00
3324821	Floor Shelf, 42"W x 21"D, Fits 48"W Frame	26	649.00
3326021	Floor Shelf, 54"W x 21"D, Fits 60"W Frame	30	697.00
350218	Floor Shelf Caster Kit (2 lock, 2 non-lock) + Handle	2	77.00
350216	Floor Shelf Glide Kit (set of 4)	1	89.00

Office Suites  
Seating  
Tables & Desks  
Meeting Essentials  
Personal Organization  
Ergonomics  
High Density Storage  
Storage & Filing  
Facilities  
Technology Furniture  
Art & Engineering  
K-12 Education  
SAFE Collection Addendum

## MAYTRIX DESK WORK SURFACE

- Includes mounting brackets
- 36" D surfaces include adjustable front support legs

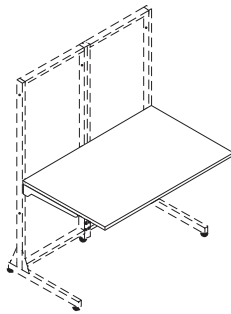

Model No.	Description	Weight	TFL	HPL	ESD
			Laminate List Price	Laminate List Price	Laminate List Price
			"L" Suffix	"LE" Suffix	
3402430	Work Surface, 24"W x 30"D	24	808.00	1,050.00	1,491.00
3403030	Work Surface, 30"W x 30"D	30	916.00	1,196.00	1,644.00
3403630	Work Surface, 36"W x 30"D	34	1,011.00	1,312.00	1,776.00
3404830	Work Surface, 48"W x 30"D	45	1,209.00	1,598.00	2,088.00
3405430	Work Surface, 54"W x 30"D	45	1,385.00	1,807.00	2,379.00
3406030	Work Surface, 60"W x 30"D	56	1,577.00	2,006.00	2,538.00
3407230	Work Surface, 72"W x 30"D	78	1,718.00	2,177.00	2,736.00
3409030	Work Surface, 90"W x 30"D	96	2,177.00	2,806.00	3,415.00
3402436	Work Surface, 24"W x 36"D	29	1,091.00	1,240.00	1,628.00
3403036	Work Surface, 30"W x 36"D	33	1,166.00	1,593.00	1,776.00
3403636	Work Surface, 36"W x 36"D	42	1,295.00	1,549.00	2,042.00
3404836	Work Surface, 48"W x 36"D	64	1,453.00	1,879.00	2,486.00
3405436	Work Surface, 54"W x 36"D	66	1,809.00	2,120.00	2,796.00
3406036	Work Surface, 60"W x 36"D	67	1,812.00	2,357.00	3,106.00
3407236	Work Surface, 72"W x 36"D	75	2,051.00	2,568.00	3,392.00
3409036	Work Surface, 90"W x 36"D	90	2,537.00	3,291.00	4,359.00

Note: TFL = Low Pressure Laminate as standard.

## MAYTRIX PENINSULA

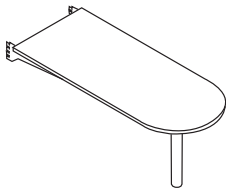

Model No.	Description	Weight	TFL	HPL	ESD
			Laminate List Price	Laminate List Price	Laminate List Price
			"L" Suffix	"LE" Suffix	
<b>Maytrix Peninsula (includes mounting brackets - hooks onto Maytrix™ frame)</b>					
3407130	71" L x 30"W with T-mold Edge	83	1,733.00	2,213.00	2,510.00

Note: Post-formed edge not available on peninsula surface. Surface height must be set nominally at 29".

## MAYTRIX 90° CORNER WORK SURFACES

Model No.	Description	Weight	List Price
<b>Maytrix Corner Components - Shelves</b>			
3332416	90° Steel Corner Shelf, 24"W x 16"D (requires two 24" frames)	20	532.00
3332420	90° Steel Corner Shelf, 24"W x 20"D (requires two 24" frames)	22	543.00
3333016	90° Steel Corner Shelf, 30"W x 16"D (requires two 30" frames)	22	549.00
3333616	90° Steel Corner Shelf, 36"W x 16"D (requires two 36" frames)	25	573.00
3333020	90° Steel Corner Shelf, 30"W x 20"D (requires two 30" frames)	25	573.00
3333620	90° Steel Corner Shelf, 36"W x 20"D (requires two 36" frames)	28	591.00

**MAYTRIX® 90° CORNER WORK SURFACES**

Model No.	Description	TFL Laminate List Price	HPL Laminate List Price	ESD Laminate List Price
			"L" Suffix	"LE" Suffix
<b>3403030</b> (requires two 30" frames; 350213L/350213R legs recommended).	30"W x 30"D	916.00	1,196.00	1,644.00
<b>3403636</b> (requires two 36" frames; 350213L/350213R legs recommended)	36"W x 36"D	1,295.00	1,549.00	2,042.00
<b>3434830</b> (requires four 24" frames)	48"W x 30"D	1,765.00	2,148.00	2,510.00
<b>3434836</b> (requires four 24" frames)	48"W x 36"D	1,962.00	2,346.00	2,668.00

Model No.	Description	List Price	List Price
<b>350217</b> (foot and hardware required for 90° corner configuration)	Corner Connector Kit	236.00	236.00

**HOW TO SPECIFY**

Start with base model number for work surfaces or peninsula and **SELECT ONE CODE FROM EACH OF THE OPTIONS** to complete your final model number for ordering:

Select MODEL NUMBER (ie., 3403030)	Option 1 Thermally-Fused Laminate No suffix	Option 2 High Pressure Laminate L = HPL Laminate	Option 3 ESD Laminate LE = ESD Laminate
------------------------------------	--	---	--

The final model number for a surface with the base model number of 3403030 with the ESD Laminate option would be 3403030LE.

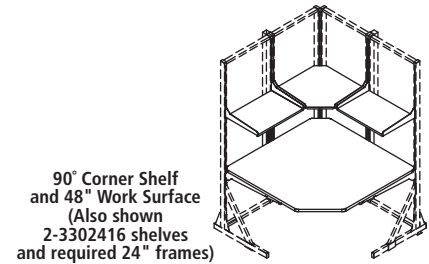
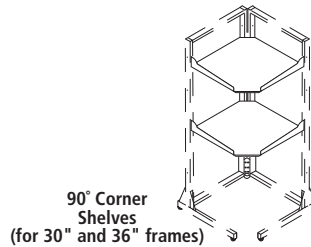
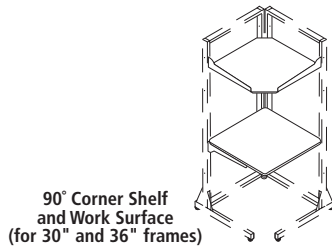

**STORAGE BINS**

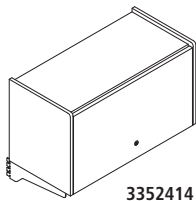

Model No.	Description	Internal Dimensions	Weight	TFL Laminate List Price	HPL Laminate List Price
					"L" Suffix
<b>3352414</b>	24"W Storage Bin	13"H x 21¼"W x 13¼"D	40	1,641.00	1,737.00
<b>3353014</b>	30"W Storage Bin	13"H x 27¼"W x 13¼"D	4	1,667.00	1,764.00
<b>3353614</b>	36"W Storage Bin	13"H x 33¼"W x 13¼"D	51	1,716.00	1,838.00

**ESD ACCESSORIES**

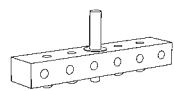

- Must be wired in compliance with local electrical codes
- Grounding Bar provides common grounding point for managing multiple ground wires
- Wrist Strap must be used with Grounding Jack for proper grounding
- Grounding Jack accommodates 4 standard banana jacks (on the end of wrist straps)

Model No.	Description	Weight	List Price
<b>787</b>	ESD Wrist Strap	2	145.00
<b>788</b>	ESD Grounding Jack	3	159.00
<b>789</b>	ESD Grounding Bar	.5	248.00

Office Suites  
Seating  
Tables & Desks  
Meeting Essentials  
Personal Organization  
Ergonomics  
High Density Storage  
Storage & Filing  
Facilities  
Technology Furniture  
Art & Education  
SAFE Collection Addendum

## MAYTRIX LAN RACKING SYSTEM

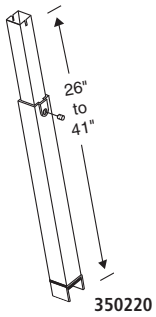

Model No.	Description	Weight	List Price
350220	Adjustable Front Support Leg - All Work Surfaces	4	304.00
350321R	Replacement Top Bracket (right) - 30"D and 36"D Work Surfaces	4	161.00
350321L	Replacement Top Bracket (left) - 30"D and 36"D Work Surfaces	4	161.00
350327R	Replacement Top Bracket (right) - All 24"D Work Surfaces	4	172.00
350327L	Replacement Top Bracket (left) - All 24"D Work Surfaces	4	172.00

**Note:** Adjustable front support leg recommended for all corner and 36" deep work surfaces.

### Maytrix Power Accessories

Model No.	Description	Weight	List Price
350181	72" L, 24 Outlet Power Strip, 15 amp, 15' Cord	4.5	579.00
350173	Power Strip, 4 ft. (10 outlets) with Surge Suppressor, 15 amp - 450 joules	5	702.00
A7737	Hardware Bags for mounting		17.00

### Maytrix Keyboard Accessories

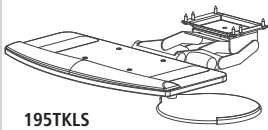

Model No.	Description	Weight	List Price
195TKLS	Trackless Keyboard/Mouse Platform 19"W x 9 1/4"D, 9" Dia. Mouse Platform Available in Black or White.	14	859.00

### Maytrix Cable Management System

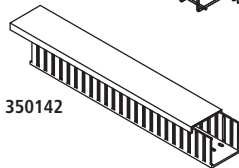
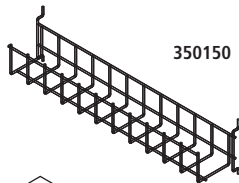

Model No.	Description	Weight	List Price
350142	2"W x 2"D, Channel (slotted), 6 ft. - Black only	3	338.00
350117	Pop Rivets - Pkg. of 25 (to attach cable channels)	1	30.00
350150	24"W, Wire Cable Trough	1	224.00
350151	30"W, Wire Cable Trough	2	288.00
350152	36"W, Wire Cable Trough	2.5	386.00

**MAYTRIX FABRIC SCREEN**

- Installs between Maytrix steel frame sections to create a private work environment

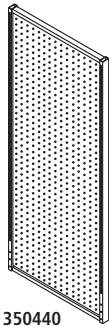

350440

Model No.	Dimensions	Weight	List Price
350440	24"W x 72"H x 1¼"D	58	1,416.00
350445	30"W x 72"H x 1¼"D	75	1,806.00
350450	36"W x 72"H x 1¼"D	92	1,901.00
350460	24"W x 60"H x 1¼"D	48	1,282.00
350465	30"W x 60"H x 1¼"D	62	1,668.00
350470	36"W x 60"H x 1¼"D	76	1,759.00
350480	24"W x 84"H x 1¼"D	68	1,598.00
350485	30"W x 84"H x 1¼"D	88	1,989.00
350490	36"W x 84"H x 1¼"D	107	2,078.00

**HOW TO ORDER MAYTRIX® FABRIC SCREENS**

**FABRIC SCREEN OPTIONS**

When ordering fabric screens, use the code at right to indicate your fabric option:

Product Code	Fabric Option
3 5 0 4 4 0	S T Y

**Fabric Color Options**

Fabric Color	Order Code
<b>Spinel</b>	
Tiger Eye	STY
Sand Stone	SSS
Guilden	SGL
<b>Lido</b>	
Balboa	LBB
Heartland	LHL
Bryce Canyon	LBC
<b>Mingle</b>	
Crystal	MCT
Khaki	MHK
Biscuit	MBT
<b>Cross Town</b>	
Buff	CBF
Ray	CRA
Fieldstone	CFS
<b>Anchorage</b>	
Goose	AGS
<b>Bailey</b>	
Khaki	BKH

Contact Customer Care at 1-888-971-6225 or email [info@safcoproducts.com](mailto:info@safcoproducts.com) for assistance.

**S/E Cabinet**

**S/E CABINET**

- The S/E Cabinet comes fully assembled, just add shelves at the spacings desired
- 3 shelves included (standard on DSP models) and adjust on 1" increments
- Optional single shelf kit available to add additional shelves to cabinet
- Empty cabinet version available (no shelves)
- Perforated locking doors with 4 hinges each
- 30" D cabinet with steel back panel and two 3" dia. pop-outs
- Tamper-proof hinges inside cabinet, not accessible from outside
- Hinge will hold doors open or keep closed without engaging the lock
- Great for storing electrical equipment due to the ventilated design and pop-outs at rear of cabinet for power purposes
- Available in Black, Graphite and Desert Sage

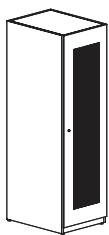

2480DSP

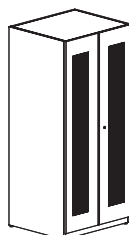

3680DSP

Model No.	Description	Dimensions	Weight	List Price
3680DSP	36"W, Double-Door Cabinet, includes 3 Shelves	36"W x 31"D x 80"H	307	9,785.00
2480DSP	24"W, Single-Door Cabinet, includes 3 Shelves	24"W x 31"D x 80"H	279	7,588.00
36801S	36"W, Single Shelf Kit for 36"W Cabinet	34"W x 28¾"D x 1"H	17	453.00
24801S	24"W, Single Shelf Kit for 24"W Cabinet	22"W x 28¾"D x 1"H	14	383.00

Model #	Description	Model #	List Price Ea.	List Carton Price	Number of Cartons	Actual Weight	S-Parcel Billable Weight	Carton Cube	Freight Class
---------	-------------	---------	----------------	-------------------	-------------------	---------------	--------------------------	-------------	---------------

**Drawing Boards:** Thermally fused 1" thick tables with low-pressure laminate surface with steel end cleats only, six top sizes

**Top Height:** 37" from floor

**Tilt Angle:** 50° from horizontal

**Available Options**

**Tool Drawer:** Comes with insert tray and lock with two keys

**Shallow Plan Drawer:** Convenient storage for papers and reference materials.

**Table is shipped KD**

Drawer Dimensions:	Height	Width	Depth
<b>Tool Drawer</b>	3 3/8"	10 3/8"	27 3/8"
<b>Shallow Drawer</b>			
<b>Table 7734B</b>	1 5/8"	24 1/4"	27 3/8"
<b>Table 7736B</b>	1 5/8"	36 1/4"	27 3/8"
<b>All other tables</b>	1 5/8"	48 1/4"	27 3/8"

**Ranger® Steel 4-Post Drawing Tables only. No Drawers.**

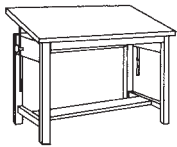

7732	Ranger® Steel 4-Post Table 42"W x 30"D x 37"H	7732	2,223.00	2,223.00	2	108	LTL	-	85
7734	Ranger® Steel 4-Post Table 48"W x 37 1/2"D x 37"H	7734	2,382.00	2,382.00	2	118	LTL	-	85
7736	Ranger® Steel 4-Post Table 60"W x 37 1/2"D x 37"H	7736	2,510.00	2,510.00	2	157	LTL	-	85
7737	Ranger® Steel 4-Post Table 72"W x 37 1/2"D x 37"H	7737	3,041.00	3,041.00	2	167	LTL	-	85
7739	Ranger® Steel 4-Post Table 84"W x 43 1/2"D x 37"H	7739	3,706.00	3,706.00	2	185	LTL	-	85

**Ranger Steel 4-Post A Combination Table with tool drawer only.**

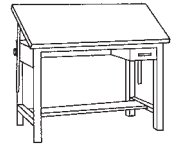

7732A	Ranger® Steel 4-Post A Combination with Tool Drawer 42"W x 30"D x 37"H	7732A	2,585.00	2,585.00	2	134	LTL	-	85
7734A	Ranger® Steel 4-Post A Combination with Tool Drawer 48"W x 37 1/2"D x 37"H	7734A	2,770.00	2,770.00	2	146	LTL	-	85
7736A	Ranger® Steel 4-Post A Combination with Tool Drawer 60"W x 37 1/2"D x 37"H	7736A	2,840.00	2,840.00	2	160	LTL	-	85
7737A	Ranger® Steel 4-Post A Combination with Tool Drawer 72"W x 37 1/2"D x 37"H	7737A	3,137.00	3,137.00	2	177	LTL	-	85
7739A	Ranger® Steel 4-Post A Combination with Tool Drawer 84"W x 43 1/2"D x 37"H	7739A	3,839.00	3,839.00	2	195	LTL	-	85

**Ranger Steel 4-Post A Combination Table with tool and shallow drawers.**

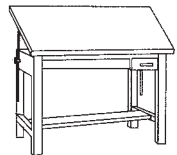

7734B	Ranger® Steel 4-Post B Combination with Tool and Shallow Drawers 48"W x 37 1/2"D x 37"H	7734B	3,015.00	3,015.00	2	156	LTL	-	85
7736B	Ranger® Steel 4-Post B Combination with Tool and Shallow Drawers 60"W x 37 1/2"D x 37"H	7736B	3,196.00	3,196.00	2	172	LTL	-	85
7737B	Ranger® Steel 4-Post B Combination with Tool and Shallow Drawers 72"W x 37 1/2"D x 37"H	7737B	3,438.00	3,438.00	2	194	LTL	-	85
7739B	Ranger® Steel 4-Post B Combination with Tool and Shallow Drawers 84"W x 43 1/2"D x 37"H	7739B	4,249.00	4,249.00	2	212	LTL	-	85

**Thermal-Fused Laminates:** Black (Black) Speckled Gray (Speckled Gray) Fog Gray (Fog Gray) Ice Gray (Ice Gray) Folkstone (Folkstone) Mahogany (Black) Bleach Birch (Bleach Birch) Cherry (Black) Mocha (Black) Anthracite (Black)

The color in (parenthesis) represents the edge band color. Example: Mahogany (Black) means the Thermally Fused Laminate is Mahogany with a Black edge band.

**Powder Coat Paint Finish:** Black-BLCK, Tech Silver-0242, White-WHIT, Mist-MIST, Navy-NAVY, Blue Medium-BLMD, Desert Sage-DESA, Textured Black-TBLK, Textured Graphite-TGHR and Textured Gray-GRAY

Office Suites  
Seating  
Tables & Desks  
Meeting Essentials  
Personal Organization  
Ergonomics  
High Density Storage  
Storage & Filing  
Facilities  
Technology Furniture  
Art & Engineering  
K-12 Education  
SAFE Collection Addendum



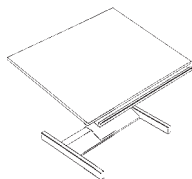



Model #	Description	Model #	List Price Ea.	List Carton Price	Number of Cartons	Actual Weight	S-Parcel Billable Weight	Carton Cube	Freight Class
<p><b>Drawing Boards:</b> Thermally-fused laminate surface, four top sizes.  <b>Top Height Range:</b> 18" travel range, 30" to 48" adjustment  <b>Tilt Angle:</b> Horizontal tilt to 89°</p>		<p><b>Electrical System:</b> 110V, 60 Hz, 24V DC motor. Draws 1.2 amps under full load.  <b>FM T/C Drive System:</b> 250 lbs. of lifting capacity and 150 foot pounds of tilting torque. All gear drive. No belts or pulleys.</p>							
<b>Futur-Matic® Drawing Tables</b>									
8693B	Futur-Matic® Drawing Tables 42"W x 30"D x 30-48"H	8693B	9,062.00	9,062.00	2	160	LTL	-	85
8694B	Futur-Matic® Drawing Tables 48"W x 37½"D x 30-48"H	8694B	9,720.00	9,720.00	2	180	LTL	-	85
8696B	Futur-Matic® Drawing Tables 60"W x 37½"D x 30-48"H	8696B	9,954.00	9,954.00	2	190	LTL	-	85
8697B	Futur-Matic® Drawing Tables 70"W x 37½"D x 30-48"H	8697B	10,220.00	10,220.00	2	242	LTL	-	85



**Thermal-Fused Laminates:** Black (Black) Speckled Gray (Speckled Gray) Fog Gray (Fog Gray) Ice Gray (Ice Gray) Folkstone (Folkstone) Mahogany (Black) Bleach Birch (Bleach Birch) Cherry (Black) Mocha (Black) Anthracite (Black)

**Powder Coat Paint Finish:** Black-BLCK, Tech Silver-0242, White-WHIT, Mist-MIST, Navy-NAVY, Blue Medium-BLMD, Desert Sage-DESA, Textured Black-TBLK, Textured Graphite-TGHR and Textured Gray-GRAY

**Drafting Tables**

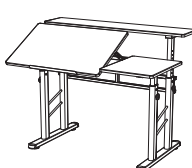









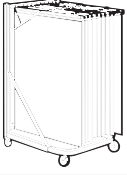

Model #	Description	Model #	List Price Ea.	List Carton Price	Number of Cartons	Actual Weight	S-Parcel Billable Weight	Carton Cube	Freight Class
3962GR	 Precision 4-Post Table Base 56½"W x 30½"D x 35½"H Finish: Gray-GR	3962GR	1,475.00	1,475.00	1	99	LTL	12.15	100
3952	 Drafting Tabletop for Precision (3962) 60"W x 37½"D x 1"H Finish: Green	3952	670.00	670.00	1	77	LTL	2.3	70
3953	 Drafting Tabletop for Precision (3962) 72"W x 37½"D x 1"H Finish: Green	3953	889.00	889.00	1	95	LTL	2.62	70
3957	 PlanMaster Drafting Table Base 43"W x 33"D x 29½" to 37½"H Finish: Black	3957	1,077.00	1,077.00	1	67	LTL	6.66	85
3948	 Drafting Tabletop for PlanMaster (3957), 37 x 60" 60"W x 37½"D x ¾"H Finish: White	3948	407.00	407.00	1	46	LTL	2.26	70
3951	 Drafting Tabletop for PlanMaster (3957), 36 x 48" 47½"W x 35½"D x ¾"H Finish: White	3951	319.00	319.00	1	34	LTL	1.7	70
3965MO	 Height-Adjustable Split-Level Drafting Table 47½"W x 29¾"D x 26"-37¾"H Finish: Medium Oak-MO	3965MO	885.00	885.00	1	75	75	3.82	85

Office Suites  
Seating  
Tables & Desks  
Meeting Essentials  
Personal Organization  
Ergonomics  
High Density Storage  
Storage & Filing  
Facilities  
Technology Furniture  
Art & Engineering  
K-12 Education  
SAFE Collection Addendum





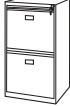

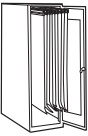

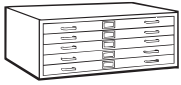
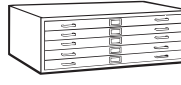

# Vertical Hanging Files

Safco® Products marketing materials are designed to be used as sales tools for our Dealer network.

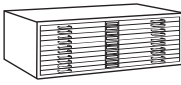
Model #	Description	Model #	List Price Ea.*	List Carton Price	Quantity Per Carton	Actual Weight	S-Parcel Billable Weight	Carton Cube	Freight Class
<b>Vertical Filing Systems</b>									
	<b>5026</b> Mobile Stand with 12 Pivot Brackets 27"W x 27½" - 37½"D x 43½" - 61½"H Finish: Tropic Sand	5026	1,495.00	1,495.00	1	47	47	2.72	70
	<b>5056</b> Data File & Extension 26½"W x 12½"D x 8"H Finish: Tropic Sand	5056	764.00	764.00	1	36	36	1.97	85
	<b>5060</b> Mobile Plan Center 25¾" - 43¾"W x 20½"D x 51"H Finish: Tropic Sand	5060	1,123.00	1,123.00	1	34	34	2.31	85
	<b>5059</b> Mobile Vertical Stand 27½" - 39¾"W x 16"D x 40" - 52"H Finish: Tropic Sand	5059	816.00	816.00	1	26	26	1.97	85
	<b>5038</b> Hanging File Folders, 18 x 14" (25/Pack)	5038	262.00	262.00	1	9	9	0.44	55
	<b>50016</b> 18" Hanging Clamp	50016	75.00	450.00	6	5	5	0.17	65
	<b>50026</b> 24" Hanging Clamp	50026	82.00	492.00	6	6	6	0.22	65
	<b>50036</b> 30" Hanging Clamp	50036	94.00	564.00	6	7	7	0.27	65
	<b>50046</b> 36" Hanging Clamp	50046	99.00	594.00	6	9	9	0.32	65
	<b>50056</b> 42" Hanging Clamp	50056	103.00	618.00	6	10	10	0.37	65
	* Only available to order by Carton.								
	<b>4311</b> Wing Knobs for Clamps - Replacement (Qty. 12)	4311	11.00	132.00	12	.08	1	0.03	70
	<b>4312</b> T-Bolts for Clamps - Replacement (Qty. 12)	4312	8.00	96.00	12	.08	1	0.03	70
	<b>5030</b> Drop/Lift Wall Rack Extends less than 12" from wall Finish: Tropic Sand	5030	136.00	136.00	1	2	2	0.15	85
	<b>5016</b> Pivot Wall Rack with 12 Pivot Brackets 24"W x 14¾"D x 9¾"H Finish: Tropic Sand	5016	650.00	650.00	1	18	18	0.88	70
	<b>5006</b> Pivot Brackets (12 Pack) 14½"W x 1¾"D x 9¾"H Finish: Gray * Only available to order by Carton.	5006	44.00	528.00	12	11	11	0.52	70
	<b>5010</b> Pivot Wall Rack 24"W x 1¾"D x 9¾"H Finish: Tropic Sand	5010	113.00	113.00	1	7	7	0.36	70
	<b>5039</b> Vertical File Cabinet 23¾"W x 24"D x 40½"H Finish: Tropic Sand	5039	2,004.00	2,004.00	1	153	LTL	16.66	100
	<b>5040</b> Small Vertical Filing Cabinet 16"W x 27"D x 42½"H	5040	1,734.00	1,734.00	1	102	LTL	18.24	100
	<b>5041</b> Large Vertical Filing Cabinet 16"W x 39"D x 54¾"H	5041	2,196.00	2,196.00	1	137	LTL	26.0	100

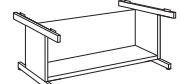
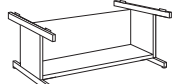
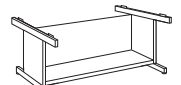

Office Suites  
Seating  
Tables & Desks  
Meeting Essentials  
Personal Organization  
Ergonomics  
High Density Storage  
Storage & Filing  
Facilities  
Technology Furniture  
Art & Engineering  
K-12 Education  
SAFE Collection Addendum

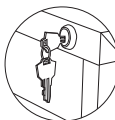
Model #	Description	Model #	List Price Ea.*	List Carton Price	Quantity Per Carton	Actual Weight	S-Parcel Billable Weight	Carton Cube	Freight Class
<b>Flat Files</b>									
	<b>4994</b> 5 Drawer Steel Flat File 36 x 24" 40 1/2" W x 29 1/2" D x 16 1/2" H <b>Finish:</b> Black-BLR, Gray-GRR, Tropic Sand-TSR, White-WHR	4994BLR 4994GRR 4994TSR 4994WHR	2,940.00	2,940.00	1	160	LTL	16.88	100
	<b>4996</b> 5 Drawer Steel Flat File 42 x 30" 46 1/2" W x 35 1/2" D x 16 1/2" H <b>Finish:</b> Black-BLR, Gray-GRR Tropic Sand-TSR, White-WHR	4996BLR 4996GRR 4996TSR 4996WHR	3,398.00	3,398.00	1	195	LTL	21.86	100
	<b>4998</b> 5 Drawer Steel Flat File 48 x 36" 53 1/2" W x 41 1/2" D x 16 1/2" H <b>Finish:</b> Black-BLR, Gray-GRR Tropic Sand-TSR, White-WHR	4998BLR 4998GRR 4998TSR 4998WHR	4,024.00	4,024.00	1	250	LTL	29.57	100
	<b>4986</b> 10 Drawer Steel Flat File 42 x 30" 46 1/2" W x 35 1/2" D x 16 1/2" H <b>Finish:</b> Black-BL, Gray-GR, Tropic Sand-TS, White-WH	4986BL 4986GR 4986TS 4986WH	6,005.00	6,005.00	1	278	LTL	19.33	100
	<b>4995</b> Closed Base 6" H for 4994 40 1/2" W x 26 1/2" D x 6" H <b>Finish:</b> Black-BLR, Gray-GRR, Tropic Sand-TSR, White-WHR	4995BLR 4995GRR 4995TSR 4995WHR	514.00	514.00	1	22	22	0.87	85
	<b>4997</b> Closed Base 6" H for 4986 & 4996 46 1/2" W x 32 1/2" D x 6" H <b>Finish:</b> Black-BLR, Gray-GRR, Tropic Sand-TSR, White-WHR	4997BLR 4997GRR 4997TSR 4997WHR	551.00	551.00	1	26	26	0.98	85
	<b>4999</b> Closed Base 6" H for 4998 53 1/2" W x 38 1/2" D x 6" H <b>Finish:</b> Black-BLR, Gray-GRR, Tropic Sand-TSR, White-WHR	4999BLR 4999GRR 4999TSR 4999WHR	690.00	690.00	1	30	30	1.12	100
	<b>4975</b> Open Base 20" H for 4994 40 1/2" W x 29 1/2" D x 20" H <b>Finish:</b> Black-BL, Gray-GR, Tropic Sand-TS, White-WH	4975BL 4975GR 4975TS 4975WH	1,128.00	1,128.00	1	37	37	1.97	85
	<b>4977</b> Open Base 20" H for 4986 & 4996 46 1/2" W x 35 1/2" D x 20" H <b>Finish:</b> Black-BL, Gray-GR, Tropic Sand-TS, White-WH	4977BL 4977GR 4977TS 4977WH	1,201.00	1,201.00	1	42	42	2.61	85
	<b>4979</b> Open Base 20" H for 4998 53 1/2" W x 41 1/2" D x 20" H <b>Finish:</b> Black-BL, Gray-GR, Tropic Sand-TS, White-WH	4979BL 4979GR 4979TS 4979WH	1,252.00	1,252.00	1	47	47	2.57	85
<b>Dividers &amp; Lock Accessories</b>									
	<b>4980</b> Flat File Dividers for 5 Drawer Steel Flat Files 1 1/2" H x 11" L	4980	193.00	193.00	1	2	2	0.13	70
	<b>4981</b> Lock Kit for 5 Drawer Steel Flat Files	4981	174.00	174.00	1	1	1	0.9	70
	<b>4983</b> Lock Kit for 10 Drawer Steel Flat Files	4983	174.00	174.00	1	1	1	0.9	70

Office Suites  
Seating  
Tables & Desks  
Meeting Essentials  
Personal Organization  
Ergonomics  
High Density Storage  
Storage & Filing  
Facilities  
Technology Furniture  
Art & Engineering  
K-12 Education  
SAFE Collection Addendum

## To order, please specify:

Series (File/Base) + Color

### Designer Color Choices:

- |                  |                     |                     |                 |
|------------------|---------------------|---------------------|-----------------|
| Baby Wheat-BW    | Calm Shore-CS       | Indigo Root-IR      | Deep Quarry-DQ  |
| Pot of Gold-PG   | Lobster Trap-LB     | Bermuda Triangle-BT | Sweet Cream-SC  |
| Cool Cucumber-CC | Taste of Tuscany-TT | Chai Tea-CT         | Pepper Stone-PS |
| Arabian Sky-AS   | Wild Wood Pine-WP   | Sand Dunes-SD       | Sweet Pea-SW    |

Example:

**STEP 1**

• 4998 5 Drawer

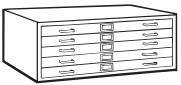

**4 9 9 8**

+





**STEP 2**

• Pot of Gold





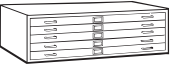
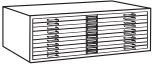
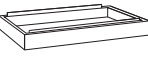

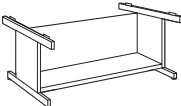
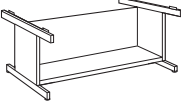
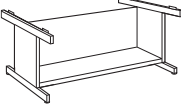
**P G**

Flat files and bases can also be ordered in customer specified colors for an upcharge. Fill out the Custom Request form on page 11 or email [specials@safcoproducts.com](mailto:specials@safcoproducts.com).



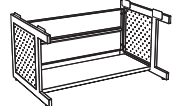

Model #	Description	Model #	List Price Ea.	List Carton Price	Quantity Per Carton	Actual Weight	S-Parcel Billable Weight	Carton Cube	Freight Class
<b>Flat Files - Custom Designer Colors</b>									
	<b>4994 Series</b> 5 Drawer Steel Flat File, 36 x 24" 40 1/2"W x 29 1/2"D x 16 1/2"H	Designer Colors	4994	2,940.00	2,940.00	1	160	LTL	16.88 100
	<b>4996 Series</b> 5 Drawer Steel Flat File, 42 x 30" 46 1/2"W x 35 1/2"D x 16 1/2"H	Designer Colors	4996	3,400.00	3,400.00	1	195	LTL	21.86 100
	<b>4998 Series</b> 5 Drawer Steel Flat File, 48 x 36" 53 1/2"W x 41 1/2"D x 16 1/2"H	Designer Colors	4998	4,025.00	4,025.00	1	250	LTL	29.57 100
	<b>4986 Series</b> 10 Drawer Steel Flat File, 42 x 30" 46 1/2"W x 35 1/2"D x 16 1/2"H	Designer Colors	4986	6,009.00	6,009.00	1	278	LTL	19.33 100
	<b>4995 Series</b> Closed Base 6"H for 4994 40 1/2"W x 26 1/2"D x 6"H	Designer Colors	4995	514.00	514.00	1	22	22	0.87 85
	<b>4997 Series</b> Closed Base 6"H for 4986 & 4996 46 1/2"W x 32 1/2"D x 6"H	Designer Colors	4997	551.00	551.00	1	26	26	0.98 85
	<b>4999 Series</b> Closed Base 6"H for 4998 53 1/2"W x 38 1/2"D x 6"H	Designer Colors	4999	690.00	690.00	1	30	30	1.12 85
	<b>4975 Series</b> Open Base 20"H for 4994 40 1/2"W x 29 1/2"D x 20"H	Designer Colors	4975	1,128.00	1,128.00	1	37	37	1.97 85
	<b>4977 Series</b> Open Base 20"H for 4986 & 4996 46 1/2"W x 35 1/2"D x 20"H	Designer Colors	4977	1,201.00	1,201.00	1	42	42	2.61 85
	<b>4979 Series</b> Open Base 20"H for 4998 53 1/2"W x 41 1/2"D x 20"H	Designer Colors	4979	1,252.00	1,252.00	1	47	47	2.57 85

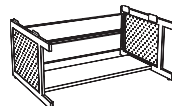
Office Suites Seating Tables & Desks Meeting Essentials Personal Organization Ergonomics High Density Storage Storage & Filing Facilities Technology Furniture Art & Engineering K-12 Education SAFE Collection Addendum

## Facil Flat Files

Model #	Description	Model #	List Price Ea.	List Carton Price	Quantity Per Carton	Actual Weight	S-Parcel Billable Weight	Carton Cube	Freight Class
<b>Facil Flat Files</b>									
	<b>4969LG</b> Facil 5 Drawer Flat File - Small 40¼"W x 26"D x 16½"H Finish: Light Gray-LG	4969LG	1,668.00	1,668.00	1	118	LTL	14.85	100
	<b>4970LG</b> Facil Closed Base for 4969LG 40¼"W x 24"D x 4¾"H Finish: Light Gray-LG	4970LG	233.00	233.00	1	13	13	0.56	85
	<b>4971LG</b> Facil High Base for 4969LG 40¼"W x 25¾"D x 20¾"H Finish: Light Gray-LG	4971LG	578.00	578.00	1	38	38	1.7	85
	<b>4972LG</b> Facil 5 Drawer Flat File - Medium 46¼"W x 32"D x 16½"H Finish: Light Gray-LG	4972LG	2,066.00	2,066.00	1	150	LTL	20.71	100
	<b>4973LG</b> Facil Closed Base for 4972LG 46¼"W x 30"D x 4¾"H Finish: Light Gray-LG	4973LG	252.00	252.00	1	16	16	0.71	85
	<b>4974LG</b> Facil High Base for 4972LG 46¼"W x 31¾"D x 20¾"H Finish: Light Gray-LG	4974LG	649.00	649.00	1	44	44	1.97	85



## MasterFile 2

Model #	Description	Model #	List Price Ea.	List Carton Price	Quantity Per Carton	Actual Weight	S-Parcel Billable Weight	Carton Cube	Freight Class
	<b>5023AH</b> MasterFile 2 Fits Sheet Size 24 x 36" 32"W x 21½"D x 45"H Finish: Autumn Haze-AH	5023AH	8,271.00	8,271.00	1	252	LTL	27.23	100
	<b>6551</b> MasterFile 2 Carrier Strips Laminite, 2¼"W x 217"L	6551	276.00	276.00	1	3	3	0.14	55
	<b>6552</b> MasterFile 2 Carrier Strips Polyester, 2¼"W x 217"L	6552	296.00	296.00	1	3	3	0.14	55
	<b>6553</b> MasterFile 2 Carrier Strips Polyester, 2½"W x 216"L	6553	276.00	276.00	1	3	3	0.14	55

Office Suites  
Seating  
Tables & Desks  
Meeting Essentials  
Personal Organization  
Ergonomics  
High Density Storage  
Storage & Filing  
Facilities  
Technology Furniture  
Art & Engineering  
K-12 Education  
SAFE Collection Addendum

# Economy Art Storage

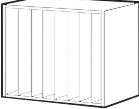

Safco® Products marketing materials are designed to be used as sales tools for our Dealer network.

Model #	Description	Model #	List Price Ea.*	List Carton Price	Quantity Per Carton	Actual Weight	S-Parcel Billable Weight	Carton Cube	Freight Class
 	<b>4897</b> Giant Stack Tray, 36 x 24" 39"W x 26"D x 3"H Finish: White <b>* Only available to order by Carton.</b>	4897	179.00	358.00	2	23	48	4.09	200
	<b>4899</b> Giant Stack Tray, 42 x 30" 45 1/4"W x 34"D x 3"H Finish: White <b>* Only available to order by Carton.</b>	4899	213.00	426.00	2	32	70	6.27	200
	<b>3030</b> Art Rack 36"W x 24 1/4"D x 29"H Finish: Textured Putty	3030	705.00	705.00	1	88	88	3.16	70

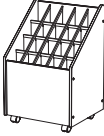
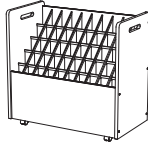

# Roll Filing Systems

Model #	Description	Model #	List Price Ea.*	List Carton Price	Quantity Per Carton	Actual Weight	S-Parcel Billable Weight	Carton Cube	Freight Class
 	<b>3084</b> Wire Roll File - 4 Compartment 16 1/4"W x 16 1/2"D x 30 1/2"H Finish: White	3084	286.00	286.00	1	15	15	0.79	70
	<b>3088</b> Tiered Wire Roll File - 24 Compartment 21"W x 14 1/4"D x 31 1/4"H Finish: White	3088	305.00	305.00	1	14	14	1.23	925
	<b>3090</b> Tubular Steel Wire Roll File - 12 Compartment 18"W x 12 3/4"D x 24 1/2"H	3090	230.00	230.00	1	8	8	0.66	925
	<b>3091</b> Tubular Steel Wire Roll File - 20 Compartment 18"W x 12 3/4"D x 24 1/2"H	3091	232.00	232.00	1	8	9	0.71	925
	<b>3079</b> Upright Roll File - 12 Compartment 15"W x 12"D x 22"H Finish: Walnut	3079	127.00	127.00	1	4	7	0.52	85
	<b>3081</b> Upright Roll File - 20 Compartment 15"W x 12"D x 22"H Finish: Walnut	3081	139.00	139.00	1	4	7	0.51	85

Office Suites  
Seating  
Tables & Desks  
Meeting Essentials  
Personal Organization  
Ergonomics  
High Density Storage  
Storage & Filing  
Facilities  
Technology Furniture  
Art & Engineering  
K-12 Education  
SAFE Collection Addendum

Model #	Description	Model #	List Price Ea.	List Carton Price	Quantity Per Carton	Actual Weight	S-Parcel Billable Weight	Carton Cube	Freight Class
 <b>3043</b>	Wood Mobile Roll File - 21 Compartment 30 1/4" W x 15 1/4" D x 29 1/4" H <b>Finish: Putty</b>	3043	700.00	700.00	1	52	52	1.8	100
 <b>3082</b>	Wood Mobile Roll File - 20 Compartment 15 1/4" W x 13 1/4" D x 23 1/4" H <b>Finish: Putty</b>	3082	420.00	420.00	1	20	21	0.7	100
 <b>3083</b>	Wood Mobile Roll File - 50 Compartment 30 1/4" W x 15 1/4" D x 29 1/4" H <b>Finish: Putty</b>	3083	753.00	753.00	1	52	52	1.83	100
 <b>3045</b>	Wood Mobile Roll File - 8 Compartment 30 1/4" W x 15 1/4" D x 29 1/4" H <b>Finish: Putty</b>	3045	682.00	682.00	1	46	46	1.84	100

Media Storage

Model #	Description	Model #	List Price Ea.	List Carton Price	Quantity Per Carton	Actual Weight	S-Parcel Billable Weight	Carton Cube	Freight Class
 <b>4935LG</b>	AV Storage Cabinet 37" W x 17 1/2" D x 27 3/4" H <b>Finish: Light Gray-LG</b>	4935LG	2,231.00	2,231.00	1	113	LTL	14.67	100
 <b>4931LG</b>	AV Cabinet Base 37" W x 17 1/2" D x 5 1/4" H <b>Finish: Light Gray-LG</b>	4931LG	256.00	256.00	1	14	14	0.61	85

Office Suites  
Seating  
Tables & Desks  
Meeting Essentials  
Personal Organization  
Ergonomics  
High Density Storage  
Storage & Filing  
Facilities  
Technology Furniture  
Art & Engineering  
K-12 Education  
SAFE Collection Addendum

Model #	Description	Model #	List Price Ea.	List Carton Price	Quantity Per Carton	Actual Weight	S-Parcel Billable Weight	Carton Cube	Freight Class
---------	-------------	---------	----------------	-------------------	---------------------	---------------	--------------------------	-------------	---------------

This section includes some favorite education-focused products, perfect for schools, universities or any learning spaces.

- Dry Erase Back standard on all storage units
- Accepts a variety of storage accessories including Whiffle totes, shelves and wardrobe bar. Whiffle totes, shelves and wardrobe bar sold separately, see page 253
- Totes held in place by pair of glides - glides included with totes
- Standard 3" 360° swivel casters, units include 4 casters (2 locking, 2 non locking), 3908 includes 5 casters (2 locking, 3 non-locking)
- 48"H and 60"H units accept wardrobe bar, 27¼"H units do not
- Double column units: middle divider is optional, can be removed upon assembly
- Triple column units: choose either one or two divider columns during assembly
- Horizontal surfaces and doors come standard in Maple wood laminate
- Order all doors separately as upcharge. See page 253 for configuring doors
- All locks are keyed-alike and feature removable cores for installing keyed different locks after market
- Side Panel Colors: Electric Blue-EBU, Green-GRN, Gray-GRY, Orange-ORG, Red-RED, Spectrum Blue-SBU
- Button Color: Electric Blue-EBU, Green-GRN, Gray-GRY, Orange-ORG, Red-RED, Spectrum Blue-SBU
- See Unit Capacity Guide on page 253

**Whiffle Mobile Storage Units**

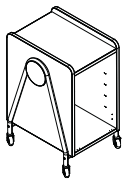

**3901** Mobile Single Column Storage Unit - 27¼"H, No Doors  
1 Grommet Hole for Cable Management  
Overall Size: 16½"W x 19¼"D x 27¼"H  
Overall Depth with door: 20½"D

3901 1,186.00 1,186.00 1 55 LTL - 85

**Doors**

No Doors - NODR  
Left Single Door - SDLT  
Right Single Door - SDRT

**Upcharge**

	N/C	N/C		
Left Single Door - SDLT	106.00	106.00	1	6
Right Single Door - SDRT	106.00	106.00	1	6

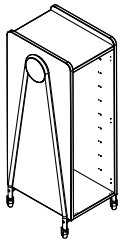

**3902** Mobile Single Column Storage Unit - 48"H, No Doors  
1 Grommet Hole for Cable Management  
Overall Size: 16½"W x 19¼"D x 48"H  
Overall Depth with door: 20½"D

3902 1,431.00 1,431.00 1 85 LTL - 85

**Doors**

No Doors - NODR  
Left Single Door - SDLT  
Right Single Door - SDRT

**Upcharge**

	N/C	N/C		
Left Single Door - SDLT	146.00	146.00	1	10.5
Right Single Door - SDRT	146.00	146.00	1	10.5

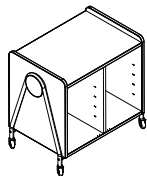

**3903** Mobile Double Column Storage Unit - 27¼"H, No Doors  
2 Grommet Holes for Cable Management  
Overall Size: 30"W x 19¼"D x 27¼"H  
Overall Depth with door: 20½"D

3903 1,254.00 1,254.00 1 86 LTL - 70

**Doors**

No Doors - NODR  
Left Double Door - DDLT  
Right Double Door - DDRT  
Two Double Doors - DDBO

**Upcharge**

	N/C	N/C		
Left Double Door - DDLT	94.00	94.00	1	6
Right Double Door - DDRT	94.00	94.00	1	6
Two Double Doors - DDBO	187.00	187.00	2	12

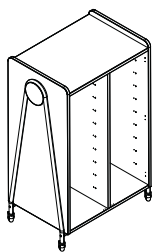

**3904** Mobile Double Column Storage Unit - 48"H, No Doors  
2 Grommet Holes for Cable Management  
Overall Size: 30"W x 19¼"D x 48"H  
Overall Depth with door: 20½"D

3904 1,527.00 1,527.00 1 125 LTL - 85

**Doors**

No Doors - NODR  
Left Double Door - DDLT  
Right Double Door - DDRT  
Two Double Doors - DDBO

**Upcharge**

	N/C	N/C		
Left Double Door - DDLT	127.00	127.00	1	10.5
Right Double Door - DDRT	127.00	127.00	1	10.5
Two Double Doors - DDBO	255.00	255.00	2	21

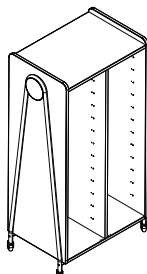

**3905** Mobile Double Column Storage Unit - 60"H, No Doors  
2 Grommet Holes for Cable Management  
Overall Size: 30"W x 19¼"D x 60"H  
Overall Depth with door: 20½"D



3905 1,908.00 1,908.00 1 150 LTL - 70

**Doors**

No Doors - NODR  
Left Double Door - DDLT  
Right Double Door - DDRT  
Two Double Doors - DDBO

**Upcharge**

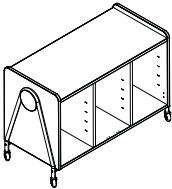
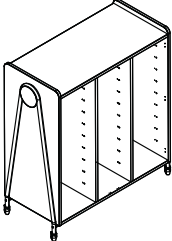
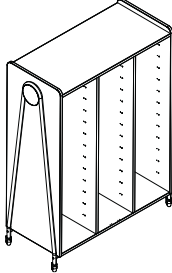
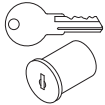
	N/C	N/C		
Left Double Door - DDLT	185.00	185.00	1	13
Right Double Door - DDRT	185.00	185.00	1	13
Two Double Doors - DDBO	368.00	368.00	2	26

Model #	Description	Model #	List Price Ea.*	List Carton Price	Quantity Per Carton	Actual Weight	S-Parcel Billable Weight	Carton Cube	Freight Class
<b>Whiffle Mobile Storage Units</b>									
	<b>3906</b> Mobile Triple Column Storage Unit - 27¼"H, No Doors 3 Grommet Holes for Cable Management Overall Size: 43¼"W x 19¼"D x 27¼"H Overall Depth with door: 20½"D	3906	1,595.00	1,595.00	1	120	LTL	-	70
	<b>Doors</b>			<b>Upcharge</b>					
	No Doors - NODR			N/C					
	Left Double Door - DDLT		94.00	94.00	1	6			
	Right Double Door - DDRT		94.00	94.00	1	6			
	Two Double Doors - DDBO		187.00	187.00	2	12			
	Two Triple Doors - TDBO		227.00	227.00	2	17			
	<b>3907</b> Mobile Triple Column Storage Unit - 48"H, No Doors 3 Grommet Holes for Cable Management Overall Size: 43¼"W x 19¼"D x 48"H Overall Depth with door: 20½"D	3907	1,881.00	1,881.00	1	170	LTL	-	85
	<b>Doors</b>			<b>Upcharge</b>					
	No Doors - NODR			N/C					
	Left Double Door - DDLT		127.00	127.00	1	10.5			
	Right Double Door - DDRT		127.00	127.00	1	10.5			
	Two Double Doors - DDBO		255.00	255.00	2	21			
	Two Triple Doors - TDBO		368.00	368.00	2	30			
	<b>3908</b> Mobile Triple Column Storage Unit - 60"H, No Doors 3 Grommet Holes for Cable Management Overall Size: 43¼"W x 19¼"D x 60"H Overall Depth with door: 20½"D	3908	2,291.00	2,291.00	1	230	LTL	-	70
	<b>Doors</b>			<b>Upcharge</b>					
	No Doors - NODR			N/C					
	Left Double Door - DDLT		185.00	185.00	1	13			
	Right Double Door - DDRT		185.00	185.00	1	13			
	Two Double Doors - DDBO		368.00	368.00	2	26			
	Two Triple Doors - TDBO		449.00	449.00	2	40			
	<b>Replacement Lock Cores</b>  								
	<b>REALCC0311 through REALCC0325</b> Replacement Core with Keys, Silver		42.00	42.00	1	1	1	-	110
	<b>REALCRK</b> Core Removal Tool		42.00	42.00	1	1	1	-	110
	<b>REALCMK</b> Master Key		42.00	42.00	1	1	1	-	110

● Whiffle totes, shelves and wardrobe bar sold separately. Find them on page 253 ●



# Whiffle Mobile Storage Units

Safco® Products marketing materials are designed to be used as sales tools for our Dealer network.

## Color Options

- 3921GRY** Gray Side Panel, Gray Button
- 3921SBU** Spectrum Blue Side Panel, Spectrum Blue Button
- 3921RED** Red Side Panel, Red Button

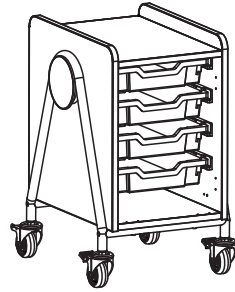

## Whiffle Typical 1 Single Column - 27 1/4", Totes, no doors

QTY	CONTENTS	MODEL NO.	LIST PRICE
1	Mobile Single Column 27 1/4" Storage Unit	<b>3901</b>	1,186.00
1	3" Totes 5 pack totes with 10 Glides	<b>3911CL</b>	148.00
<b>3921</b>			<b>1,343.00</b>

## Color Options

- 3922GRY** Gray Side Panel, Gray Button
- 3922SBU** Spectrum Blue Side Panel, Spectrum Blue Button
- 3922RED** Red Side Panel, Red Button

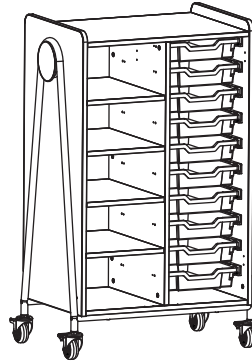

## Whiffle Typical 2 Double Column - 48", Totes & Single Shelves, no doors

QTY	CONTENTS	MODEL NO.	LIST PRICE
1	Mobile Double Column 48" Storage Unit	<b>3904</b>	1,527.00
2	Single Shelves 2 Pack	<b>3915MA</b>	102.00
2	3" Totes 5 pack totes with 10 Glides	<b>3911CL</b>	148.00
<b>3922</b>			<b>2,064.00</b>

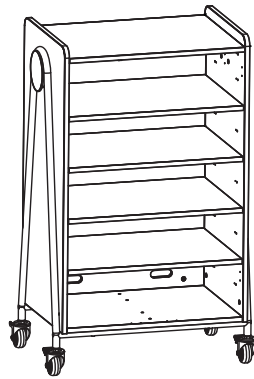

## Color Options

- 3923GRY** Gray Side Panel, Gray Button
- 3923SBU** Spectrum Blue Side Panel, Spectrum Blue Button
- 3923RED** Red Side Panel, Red Button

## Whiffle Typical 3 Double Column - 48", Double Shelves, no doors

QTY	CONTENTS	MODEL NO.	LIST PRICE
1	Mobile Double Column 48" Storage Unit	<b>3904</b>	1,527.00
2	Double Shelves 2 Pack	<b>3916MA</b>	177.00
<b>3923</b>			<b>1,890.00</b>

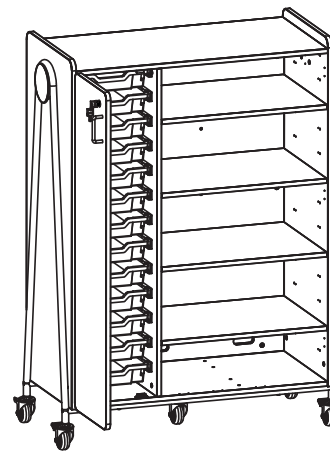

## Color Options

- 3924GRY** Gray Side Panel, Gray Button
- 3924SBU** Spectrum Blue Side Panel, Spectrum Blue Button
- 3924RED** Red Side Panel, Red Button

## Whiffle Typical 4 Triple Column - 60", Totes & Double Shelves, Left Double Door

QTY	CONTENTS	MODEL NO.	List Price
1	Mobile Triple Column 60" Storage Unit	<b>3908</b>	2,291.00
1	Left Double Door	<b>DDLTL</b>	185.00
3	3" Totes 5 pack totes with 10 Glides	<b>3911CL</b>	148.00
2	Double Shelves 2 Pack	<b>3916MA</b>	177.00
<b>3924</b>			<b>3,345.00</b>

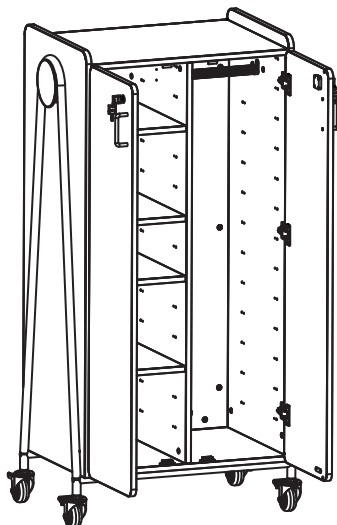

## Color Options

- 3925GRY** Gray Side Panel, Gray Button
- 3925SBU** Spectrum Blue Side Panel, Spectrum Blue Button
- 3925RED** Red Side Panel, Red Button

## Whiffle Typical 5 Double Column - 60", Wardrobe Bar & Single Shelves, Two Double Doors

QTY	CONTENTS	MODEL NO.	LIST PRICE
1	Mobile Double Column 60" Storage Unit	<b>3905</b>	1,908.00
1	Two Double Doors	<b>DDBO</b>	368.00
1	Wardrobe Bar	<b>3917</b>	95.00
2	Single Shelves 2 Pack	<b>3915MA</b>	102.00
<b>3925</b>			<b>2,608.00</b>

Office Suites  
Seating  
Tables & Desks  
Meeting Essentials  
Personal Organization  
Ergonomics  
High Density Storage  
Storage & Filing  
Facilities  
Technology Furniture  
Art & Engineering  
K-12 Education  
SAFE Collection Addendum

### Color Options

- 3926GRY Gray Side Panel, Gray Button
- 3926SBU Spectrum Blue Side Panel, Spectrum Blue Button
- 3926RED Red Side Panel, Red Button

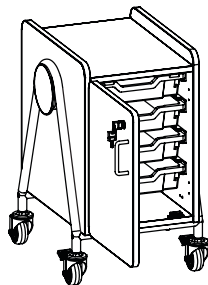

**Whiffle Typical 6** Single Column - 27¼", Totes, one Left Single Door

QTY	CONTENTS	MODEL NO.	LIST PRICE
1	Mobile Single Column 27¼" Storage Unit	3901	1,186.00
1	Left Single Door	SDLT	106.00
1	3" Totes 5 pack totes with 10 Glides	3911CL	148.00
<b>3926</b>			<b>1,502.00</b>

### Color Options

- 3927GRY Gray Side Panel, Gray Button
- 3927SBU Spectrum Blue Side Panel, Spectrum Blue Button
- 3927RED Red Side Panel, Red Button

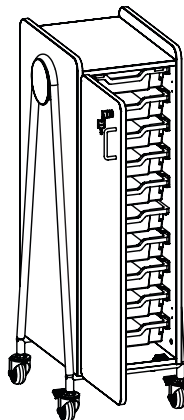

**Whiffle Typical 7** Single Column - 48", Totes, one Left Single Door

QTY	CONTENTS	MODEL NO.	LIST PRICE
1	Mobile Single Column 48" Storage Unit	3902	1,431.00
1	Left Single Door	SDLT	146.00
2	3" Totes 5 pack totes with 10 Glides	3911CL	148.00
<b>3927</b>			<b>1,919.00</b>

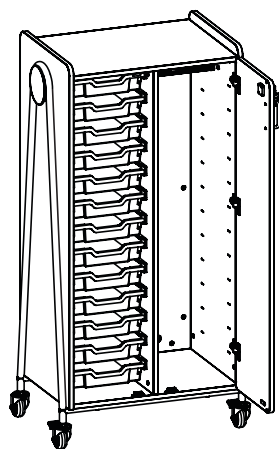

### Color Options

- 3928GRY Gray Side Panel, Gray Button
- 3928SBU Spectrum Blue Side Panel, Spectrum Blue Button
- 3928RED Red Side Panel, Red Button

**Whiffle Typical 8** Double Column - 60", Totes, Wardrobe Bar, Right Double Door

QTY	CONTENTS	MODEL NO.	LIST PRICE
1	Mobile Double Column 60" Storage Unit	3905NODR	1,908.00
1	Right Double Door	DDRT	185.00
1	Wardrobe Bar	3917	95.00
3	3" Totes 5 pack totes with 10 Glides	3911CL	148.00
<b>3928</b>			<b>2,697.00</b>

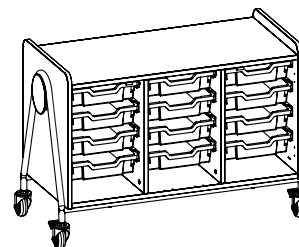

### Color Options

- 3929GRY Gray Side Panel, Gray Button
- 3929SBU Spectrum Blue Side Panel, Spectrum Blue Button
- 3929RED Red Side Panel, Red Button

**Whiffle Typical 9** Triple Column - 27¼", Totes, no doors

QTY	CONTENTS	MODEL NO.	List Price
1	Mobile Triple Column 27¼" Storage Unit	3906NODR	1,595.00
3	3" Totes 5 pack totes with 10 Glides	3911CL	148.00
<b>3929</b>			<b>2,088.00</b>

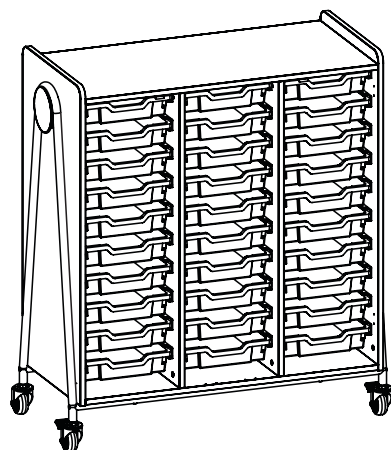

### Color Options

- 3930GRY Gray Side Panel, Gray Button
- 3930SBU Spectrum Blue Side Panel, Spectrum Blue Button
- 3930RED Red Side Panel, Red Button

**Whiffle Typical 10** Triple Column - 48"H, Totes, no doors

QTY	CONTENTS	MODEL NO.	LIST PRICE
1	Mobile Triple Column 48" Storage Unit	3907NODR	1,881.00
6	3" Totes 5 pack totes with 10 Glides	3911CL	148.00
<b>3930</b>			<b>2,847.00</b>

# Whiffle Typicals

Safco® Products marketing materials are designed to be used as sales tools for our Dealer network.



### Color Options

- 3931GRY Gray Side Panel, Gray Button
- 3931SBU Spectrum Blue Side Panel, Spectrum Blue Button
- 3931RED Red Side Panel, Red Button

**Whiffle Typical 11** Triple Column - 48", Single Shelves, no doors

QTY	CONTENTS	MODEL NO.	LIST PRICE
1	Mobile Triple Column 48" Storage Unit	3907NODR	1,881.00
6	Single Shelves 2 Pack	3915MA	102.00
<b>3931</b>			<b>2,514.00</b>

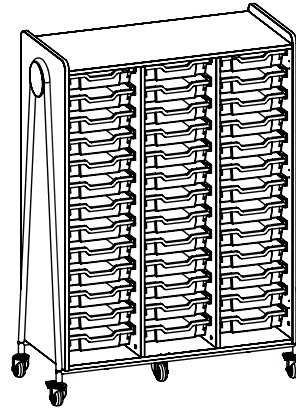

### Color Options

- 3932GRY Gray Side Panel, Gray Button
- 3932SBU Spectrum Blue Side Panel, Spectrum Blue Button
- 3932RED Red Side Panel, Red Button

**Whiffle Typical 12** Triple Column - 60", Totes

QTY	CONTENTS	MODEL NO.	LIST PRICE
1	Mobile Triple Column 60" Storage Unit	3908NODR	2,291.00
8	3" Totes 5 pack totes with 10 Glides	3911CL	148.00
<b>3932</b>			<b>3,555.00</b>

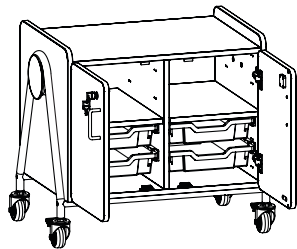

### Color Options

- 3933GRN Green Side Panel, Green Button
- 3933EBU Electric Blue Side Panel, Electric Blue Button
- 3933RED Red Side Panel, Red Button
- 3933GRY Gray Side Panel, Gray Button
- 3933SBU Spectrum Blue Side Panel, Spectrum Blue Button

**Whiffle Typical 13** Double Column - 27 1/2", Totes, Single shelves, Double Doors

QTY	CONTENTS	MODEL NO.	LIST PRICE
1	Mobile Double Column 27 1/2" Storage Unit	3903NODR	1,254.00
1	Two Double Doors	DDBO	187.00
1	3" Totes 5 pack totes with 10 Glides	3911CL	148.00
1	Single Shelves 2 Pack	3915MA	102.00
<b>3933</b>			<b>1,740.00</b>

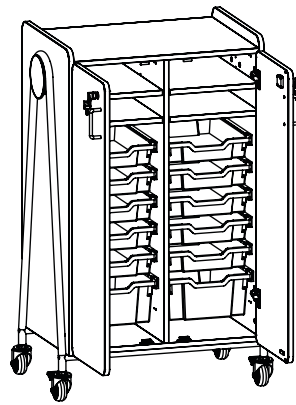

### Color Options

- 3934GRN Green Side Panel, Green Button
- 3934EBU Electric Blue Side Panel, Electric Blue Button
- 3934RED Red Side Panel, Red Button
- 3934GRY Gray Side Panel, Gray Button
- 3934SBU Spectrum Blue Side Panel, Spectrum Blue Button

**Whiffle Typical 14** Double Column - 48", Totes & Single shelves, Two Double Door

QTY	CONTENTS	MODEL NO.	List Price
1	Mobile Double Column 48" Storage Unit	3904NODR	1,527.00
1	Two Double Door	3904DDBO	255.00
1	6" Clear Totes 4 pack totes with 8 Glides	3912CL	128.00
2	3" Totes 5 pack totes with 10 Glides	3911CL	148.00
2	Single Shelves 2 Pack	3915MA	102.00
<b>3934</b>			<b>2,478.00</b>

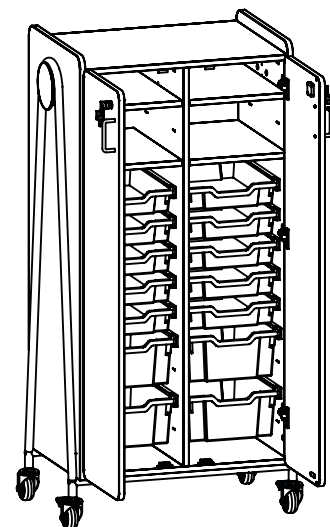

### Color Options

- 3935GRN Green Side Panel, Green Button
- 3935EBU Electric Blue Side Panel, Electric Blue Button
- 3935RED Red Side Panel, Red Button
- 3935GRY Gray Side Panel, Gray Button
- 3935SBU Spectrum Blue Side Panel, Spectrum Blue Button

**Whiffle Typical 15** Double Column - 60", Totes & Single Shelves, Two Double Doors

QTY	CONTENTS	MODEL NO.	LIST PRICE
1	Mobile Double Column 60" Storage Unit	3905	1,908.00
1	Two Double Doors	DDBO	368.00
1	6" Clear Totes 4 pack totes with 8 Glides	3912CL	128.00
2	3" Totes 5 pack totes with 10 Glides	3911CL	148.00
2	Single Shelves 2 Pack	3915MA	102.00
<b>3935</b>			<b>3,025.00</b>

Office Suites, Seating, Tables & Desks, Meeting Essentials, Personal Organization, Ergonomics, High Density Storage, Storage & Filing, Facilities, Technology Furniture, Art & Engineering, Education, SAFE Collection Addendum

Whiffle Mobile Storage Units

TO ORDER, PLEASE SPECIFY: 3 9 0 8 +    +    +     
 MODEL DOOR CHOICE SIDE PANEL FINISH BUTTON COLOR

Example: Model 3908 Mobile Triple Column 60" Storage Unit

**1** Model

• Mobile Triple Column 60"

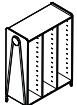

3 9 0 8

+

**2** Door Choice

• Two Double Doors

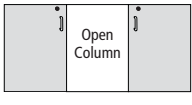

D D B O

+

**3** Side Panel Color

• Electric Blue



E B U

+

**4** Button Color

• Green



G R N

+

**5** Accessories

• All accessories ordered separately with an upcharge. See table below for information.

**1** Whiffle Mobile Storage Units

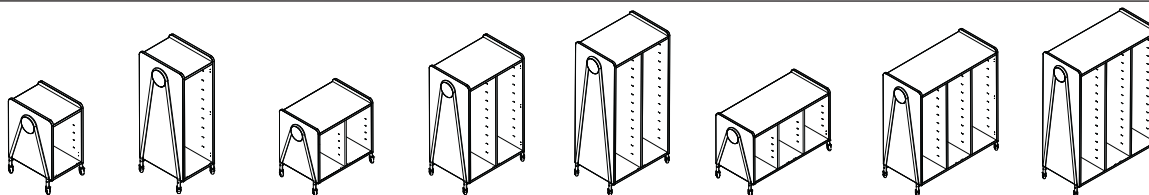

Model #	3901	3902	3903	3904	3905	3906	3907	3908
Whiffle™ Mobile Storage Units	Single Column 27¼"H	Single Column 48"H	Double Column 27¼"H	Double Column 48"H	Double Column 60"H	Triple Column 27¼"H	Triple Column 48"H	Triple Column 60"H
3" Tote - Capacity*	4	10	8	20	26	12	30	39
6" Tote - Capacity*	2	5	4	10	12	6	15	18
9" Tote - Capacity*	1	3	2	6	8	3	9	12
12" Tote - Capacity*	1	2	2	4	6	3	6	9
Single Shelf - Capacity	4	10	8	20	26	12	30	39
Double Shelf - Capacity	-	-	4	10	13	4	10	13
Door Options	No Door	No Door	No Door	No Door	No Doors	No Doors	No Doors	No Doors
	Left Single Door	Left Single Door	Left Double Door	Left Double Door	Left Double Door	Left Double Door	Left Double Door	Left Double Door
	Right Single Door	Right Single Door	Right Double Door	Right Double Door	Right Double Door	Right Double Door	Right Double Door	Right Double Door
	-	-	2 Double Doors	2 Double Doors	2 Double Doors	2 Double Doors	2 Double Doors	2 Double Doors
	-	-	-	-	-	2 Triple Doors	2 Triple Doors	2 Triple Doors
Divider Options	NA	NA	Center Divider Optional	Center Divider Optional	Center Divider Optional	Can use 1 or 2 Dividers	Can use 1 or 2 Dividers	Can use 1 or 2 Dividers
Wardrobe Bar	No	Yes	No	Yes	Yes	No	Yes	Yes

\*Tote totals are only if doing all totes. Accessories can be mixed to create your ideal storage solutions. Contact our Space Planning team if you need help designing your unit at spaceplanning@safcoproducts.com. Call us at 1-800-735-6869 if you have any questions.

**2** Door Choice

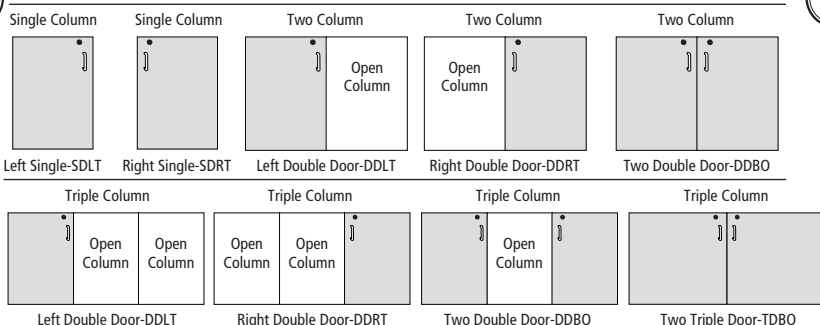

**3** Side Panel Color

- Electric Blue-EBU
- Green-GRN
- Gray-GRY
- Orange-ORG
- Red-RED
- Spectrum Blue-SBU

**4** Button Color

- Electric Blue-EBU
- Green-GRN
- Gray-GRY
- Orange-ORG
- Red-RED
- Spectrum Blue-SBU

**5**

Model # Description

Storage Accessories - Order Separately

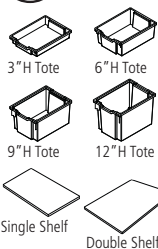

Plastic Totes

<b>3911CL</b>	3"H Clear Totes, 5 Pack with 10 Glides, 12¼"W x 16¾"D x 3"H	148.00	5	7.35	-	-	-
<b>3912CL</b>	6"H Clear Totes, 4 Pack with 8 Glides, 12¼"W x 16¾"D x 6"H	128.00	4	7.8	-	-	-
<b>3913CL</b>	9"H Clear Totes, 3 Pack with 6 Glides, 12¼"W x 16¾"D x 9"H	141.00	3	6.75	-	-	-
<b>3914CL</b>	12"H Clear Totes, 2 Pack with 4 Glides, 12¼"W x 16¾"D x 12"H	128.00	2	5.6	-	-	-
<b>3918</b>	Mobile Stop Clips, 5 Pk	40.00	5	0.2	-	-	-

Shelves

<b>3915MA</b>	Single Shelves, 12¼"W x 19"D x ¾"H, 2 Pk	102.00	2	-	-	-	-
<b>3916MA</b>	Double Shelves, 26¼"W x 19"D x ¾"H, 2 Pk for use when removing divider column in double or triple units	177.00	2	-	-	-	-

Wardrobe Bar

<b>3917</b>	Wardrobe Bar (Cannot be used in 28¼"H Storage Units)	95.00	1	-	-	-	-
-------------	--	-------	---	---	---	---	---

List Price Ea.	Quantity Per Pack	Actual Weight	S-Parcel Billable Weight	Carton Cube	Freight Class
148.00	5	7.35	-	-	-
128.00	4	7.8	-	-	-
141.00	3	6.75	-	-	-
128.00	2	5.6	-	-	-
40.00	5	0.2	-	-	-
102.00	2	-	-	-	-
177.00	2	-	-	-	-
95.00	1	-	-	-	-

Office Suites  
Seating  
Tables & Desks  
Meeting Essentials  
Personal Organization  
Ergonomics  
High Density Storage  
Storage & Filing  
Facilities  
Technology Furniture  
Art & Engineering  
K-12 Education  
SAFE Collection Addendum

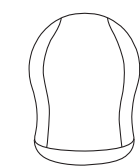
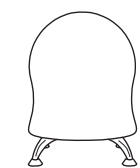
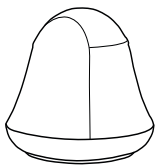
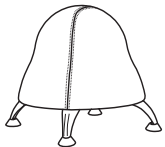

Office Suites  
Seating  
Tables & Desks  
Meeting Essentials  
Personal Organization  
Ergonomics  
High Density Storage  
Storage & Filing  
Facilities  
Technology Furniture  
Art & Engineering  
K-12 Education  
SAFE Collection Addendum

Model #	Description	Model #	List Price Ea.	List Carton Price	Quantity Per Carton	Actual Weight	S-Parcel Billable Weight	Carton Cube	Freight Class
<b>Runtz™ Ball Chair</b>									
4755	Runtz™ Ball Chair Seat Height: 16-17" Seat Size: 12" Dia. Overall: 22½" Dia. x 16-17"H <b>Fabric:</b> Licorice-BL, Blue-BU, Sour Apple-GS, Orange-OR, Bubble Gum-PI	4755	350.00	350.00	1	14	21	1.8	125
4756	Runtz™ Ball Chair <b>Vinyl:</b> Black Vinyl-BV, Blue-BUV, Green-GV, Red-RV  (Legs come with option for 2 height settings)	4756BV 4756BUV 4756GV 4756RV	350.00	350.00	1	14	21	1.83	125
<b>Runtz™ Ball Chair, Vinyl Series</b>									
4757	Runtz™ Ball Chair, Vinyl Series Grade 2 Vinyl, Canter, Dot.com, Hathaway	4757	590.00	590.00	1	14	21	1.83	150
	2 Tone Vinyl  (Legs come with option for 2 height settings)	4757	628.00	628.00					
<b>Runtz™ Swivel Ball Chair</b>									
4761	Runtz™ Swivel Ball Chair Seat Size: 12" Dia. Overall: 22½" Dia. x 17"H <b>Fabric:</b> Black Vinyl-BV, Blue Vinyl-BUV, Green Vinyl-GV, Red Vinyl-RV	4761BV 4761BUV 4761GV 4761RV	425.00	425.00	1	16.4	24	2.3	100
<b>Runtz™ Swivel Ball Chair, Vinyl Series</b>									
4761	Runtz™ Swivel Ball Chair, Vinyl Series Grade 2 Vinyl, Canter, Dot.com, Hathaway	4761	620.00	620.00	1	16.4	24	2.33	100
	2 Tone Vinyl	4761	658.00	628.00					
<b>Zenergy™ Ball Chair</b>									
4750	Zenergy™ Ball Chair Seat Height: 22-23" Seat Size: 17½" Dia. Overall: 22½" Dia. x 22-23"H <b>Fabric:</b> Black-BL, Blue-BU, Crimson-CI, Grass-GS, Gray-GR, Orange-OR, Pink-PI	4750	375.00	375.00	1	15	21	1.8	100
4751	Zenergy™ Ball Chair, Black Vinyl-BV <b>Vinyl:</b> Black Vinyl-BV, Blue-BUV, Green-GV, Red-RV  (Legs come with option for 2 height settings)	4751BV 4751BUV 4751GV 4751RV	375.00	375.00	1	16	20	1.76	100
<b>Zenergy™ Ball Chair, Vinyl Series</b>									
4753	Zenergy™ Ball Chair, Vinyl Series Grade 1 Vinyl: Dillon, Grade 2 Vinyl: Canter, Canyon, Dot.com, Hathaway Phoenix, Persuasion, Whisper, Vibe	4753	605.00	605.00	1	16	21	1.8	150
	2 Tone Vinyl  (Legs come with option for 2 height settings)	4753	643.00	643.00					
<b>Zenergy™ Swivel Ball Chair</b>									
4760	Zenergy™ Swivel Ball Chair Seat Size: 17½" Dia. Overall: 17½" Dia. x 23"H <b>Fabric:</b> Black-BL, Blue-BU, Green-GN, Orange-OR <b>Vinyl:</b> Black Vinyl-BV, Blue-BUV, Green-GV, Red-RV	4760BL 4760BU 4760GN 4760OR 4760BV	445.00	445.00	1	16	22	2.06	85
<b>Zenergy™ Swivel Ball Chair, Vinyl Series</b>									
4760	Zenergy™ Swivel Ball Chair, Vinyl Series Grade 1 Vinyl: Dillon, Grade 2 Vinyl: Canter, Canyon, Dot.com, Hathaway Phoenix, Persuasion, Whisper, Vibe	4760	640.00	640.00	1	16	22	2.06	85
	2 Tone Vinyl	4760	679.00	679.00					
<b>Replacement Inner Ball and Plug:</b>									
220000075	Zenergy Inner Ball and Plug	220000075	51.00						
220000076	Runtz Inner Ball and Plug	220000076	51.00						

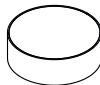

Designed by Thomas Walser.

Designed by Thomas Walser.

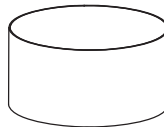
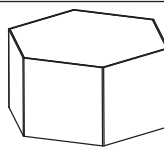
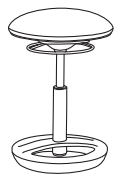
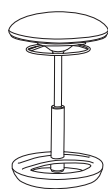





Model #	Description	Model #	List Price Ea.*	List Carton Price	Quantity Per Carton	Actual Weight	S-Parcel Billable Weight	Carton Cube	Freight Class
<b>Learn Soft Seating</b>									
	<b>8121</b> Learn 15" Round Floor Seat - Easy clean vinyl Overall Size: 15"Dia. x 5 1/4"H <b>Vinyl:</b> Black- BV, Blue- BUV, Green- GV, Red- RV	8121BV 8121BUV 8121GV 8121RV	242.00	242.00	1	8	11	0.93	150
	<b>8121</b> Learn 15" Round Floor Seat - Configured Vinyls Grade 2 Vinyl, Canter, Dot.com, Hathaway	8121	375.00	375.00	1	8	11	0.93	150
	<b>8122</b> Learn 15" Cylinder Vinyl Seat - Easy clean vinyl 2 height options: 1" Levelers, 3" Tall Feet (both come in box) Overall Size: 15"Dia. x 15 3/4 - 18"H <b>Vinyl:</b> Black- BV, Blue- BUV, Green- GV, Red- RV	8122BV 8122BUV 8122GV 8122RV	331.00	331.00	1	13.4	27	2.33	150
	<b>8122</b> Learn 15" Cylinder Vinyl Seat - Configured Vinyls Grade 2 Vinyl, Canter, Dot.com, Hathaway	8122	483.00	483.00	1	13.4	27	2.33	150
	<b>8123</b> Learn 30" Cylinder Vinyl Ottoman - Easy clean vinyl 2 height options: 1" Levelers, 3" Tall Feet (both come in box) Overall Size: 30"Dia. x 15 3/4 - 18"H <b>Vinyl:</b> Blue- BUV, Green- GV, Red- RV	8123BUV 8123GV 8123RV	882.00	882.00	1	40.6	93	9.19	150
	<b>8123</b> Learn 30" Cylinder Vinyl Ottoman - Configured Vinyls Grade 2 Vinyl, Canter, Dot.com, Hathaway	8123	1,072.00	1,072.00	1	40.6	93	9.19	150
	<b>8124</b> Learn 30" Hexagon Vinyl Ottoman - Easy clean vinyl 2 height options: 1" Levelers, 3" Tall Feet (both come in box) Overall Size: 29 3/4"Dia. x 15 3/4 - 18"H <b>Vinyl:</b> Blue- BUV, Green- GV, Red- RV	8124BUV 8124GV 8124RV	881.00	881.00	1	35.2	93	8.82	150
	<b>8124</b> Learn 30" Hexagon Vinyl Ottoman - Configured Vinyls Grade 2 Vinyl, Canter, Dot.com, Hathaway	8124	1,072.00	1,072.00	1	35.2	93	8.82	150
<b>Twixt™ Active Seating Chair ① ⑤ *</b>									
 Designed by Thomas Walser.	<b>3000</b> Twixt™ Sitting-Height Stool Seat Height: 17" - 22" Seat Size: 15"Dia. Overall: 15"Dia. x 17" - 22"H <b>Fabric:</b> Black-BL, Blue-BU, Green-GN, Orange-OR, Black Vinyl-BV	3000BL 3000BU 3000GN 3000OR 3000BV	371.00	371.00	1	16	16	1.54	150
	<b>3000</b> Twixt™ Series Sitting-Height Stool, Custom Seat Height: 17" - 22" Seat Size: 15"Dia. Overall: 15"Dia. x 17" - 22"H COM Yardage: .75 yds. Bases: Black, Chrome, White	01 02 03 COM NC	39.00 59.00 82.00 59.00 59.00	39.00 59.00 82.00 59.00 59.00	1	16	16	1.54	150
<b>Twixt™ Active Seating Chair ① ⑤ *</b>									
 Designed by Thomas Walser.	<b>3001</b> Twixt™ Extended-Height Stool Seat Height: 22" - 31 3/4" Seat Size: 15 1/2"Dia. Overall: 15 1/2"Dia. x 22" - 31 3/4"H <b>Fabric:</b> Black-BL, Blue-BU, Green-GN, Orange-OR, Black Vinyl-BV	3001BL 3001BU 3001GN 3001OR 3001BV	408.00	408.00	1	17	19	1.76	150
	<b>3001</b> Twixt™ Series Extended-Height Stool, Custom Seat Height: 22" - 31 3/4" Seat Size: 15 1/2"Dia. Overall: 15 1/2"Dia. x 22" - 31 3/4"H COM Yardage: .75 yds. Bases: Black, Chrome, White	01 02 03 COM NC	39.00 59.00 82.00 59.00 59.00	39.00 59.00 82.00 59.00 59.00	1	17	19	1.76	150

\*See page 51 for Chair Features and Chair Functions.



# Stools



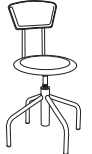



Safco® Products marketing materials are designed to be used as sales tools for our Dealer network.

Model #	Description	Model #	List Price Ea.	List Carton Price	Quantity Per Carton	Actual Weight	S-Parcel Billable Weight	Carton Cube	Freight Class
	<b>SitStar™ Stool 1 5*</b> <b>6660</b> SitStar™ Chrome Base Stool with Adjustable Footring Seat Height: 22" - 32" Seat: 19"W x 14"D Base: 26"Dia. <b>Finish:</b> Black-BL, Blue-BU <b>Optional Accessories:</b> 5132 Hard Floor Casters and 5138 2" Nylon Glides, see Page 85	6660BL 6660BU	624.00	624.00	1	31	38	3.6	100
	<b>Steel Stools</b> <b>6603</b> Guest-Height Steel Stool Seat Height: 15" Seat: 13"W x 13"D Overall: 15¼"W x 15¼"D x 15"H <b>Finish:</b> Black-BL, Blue-BU, Red-RD, Silver-SL, White-WH	6603BL 6603BU 6603RD 6603SL 6603WH	142.00	142.00	1	10	10	0.68	85
	<b>6604</b> Guest-Height Steel Stool Seat Height: 18" Seat: 13"W x 13"D Overall: 15¼"W x 15¼"D x 18"H <b>Finish:</b> Black-BL, Blue-BU, Red-RD, Silver-SL, White-WH	6604BL 6604BU 6604RD 6604SL 6604WH	142.00	142.00	1	10	10	0.68	85
	<b>6605</b> Counter-Height Steel Stool Seat Height: 25" Seat: 13"W x 13"D Overall: 17¼"W x 17¼"D x 25"H <b>Finish:</b> Black-BL, Blue-BU, Red-RD, Silver-SL, White-WH	6605BL 6605BU 6605RD 6605SL 6605WH	165.00	165.00	1	11	12	0.95	85
	<b>6606</b> Bar-Height Steel Stool Seat Height: 29" Seat: 13"W x 13"D Overall: 17¼"W x 17¼"D x 29"H <b>Finish:</b> Black-BL, Blue-BU, Red-RD, Silver-SL, White-WH	6606BL 6606BU 6606RD 6606SL 6606WH	182.00	182.00	1	12	13	1.11	925
	<b>Diesel Series Industrial Stools</b> <b>6666</b> Diesel Adjustable-Height 1* Seat Height: 23½" - 29½" Seat: 14"Dia. Overall: 17¼"Dia. x 29¼"H <b>Finish:</b> Pewter, Silver-SL	6666 6666SL	203.00	203.00	1	16	45	4.34	250
	<b>6668</b> Diesel Low Base with Back 1 5* Seat Height: 16" - 22" Seat: 14"Dia. Back: 12"W x 7"H Overall: 15"W x 15"D x 30" - 36"H <b>Finish:</b> Pewter	6668	428.00	428.00	1	19	56	5.25	250

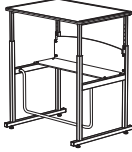
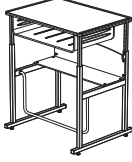
\*See page 51 for Chair Features and Chair Functions.

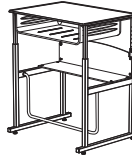

Office Suites  
Seating  
Tables & Desks  
Meeting Essentials  
Personal Organization  
Ergonomics  
High Density Storage  
Storage & Filing  
Facilities  
Technology Furniture  
Art & Engineering  
K-12 Education  
SAFE Collection Addendum





Model #	Description	Model #	List Price	List Price Ea.*	Quantity Per Carton	Actual Weight	S-Parcel Billable Weight	Carton Cube	Freight Class
<b>AlphaBetter® Desks &amp; Stools</b>									
	<b>1201BE</b> AlphaBetter® Desk 28 x 20" Standard Top 28"W x 20"D x 26" - 42"H <b>Desktop Finish:</b> Beige-BE Steel Frame with Black Powder Coat Finish Patented Swinging Pendulum™ Footrest Bar	1201BE	764.00	764.00	1	44	52	4.87	110
	<b>1202BE</b> AlphaBetter® Desk, with Book Box 28 x 20" Standard Top 28"W x 20"D x 26" - 42"H <b>Desktop Finish:</b> Beige-BE Steel Frame with Black Powder Coat Finish Patented Swinging Pendulum™ Footrest Bar	1202BE	964.00	964.00	1	50	52	4.87	110
	<b>1203</b> AlphaBetter® Desk 28 x 20" Premium Top 28"W x 20"D x 26" - 42"H <b>Desktop Finish:</b> Gray-GR, Dry Erase-DE Steel Frame with Black Powder Coat Finish Patented Swinging Pendulum™ Footrest Bar	1203GR 1203DE	819.00	819.00	1	43	52	4.87	110
	<b>1204</b> AlphaBetter® Desk 28 x 20" Premium Top 28"W x 20"D x 26" - 42"H <b>Desktop Finish:</b> Gray-GR, Dry Erase-DE Steel Frame with Black Powder Coat Finish Patented Swinging Pendulum™ Footrest Bar	1204GR 1204DE	1,017.00	1,017.00	1	49	52	4.87	110
	<b>1205</b> AlphaBetter® Stool Seat Size: 13" Sq. Overall: 15¼" - 19¼"W x 21" - 35½"H <b>Seat Finish:</b> Beige-BE, Black-BL Steel Frame with Black Powder Coat Finish	1205BE 1205BL	432.00	432.00	1	23	34	3.14	125
	<b>1212BL</b> AlphaBetter® Optional Book Box 22"W x 15"D x 4¼"H <b>Finish:</b> Black-BL	1212BL	196.00	196.00	1	8	15	1.26	250
	<b>1210BL</b> Carpet Casters for AlphaBetter®, Set of 4 Casters: 2½"H <b>Finish:</b> Black-BL	1210BL	28.00	28.00	1	1.2	2	0.08	65
	<b>1211BL</b> Hard floor Casters for AlphaBetter®, Set of 4 Casters: 2½"H <b>Finish:</b> Black-BL	1211BL	39.00	39.00	1	1.3	2	0.08	65

Office Suites  
Seating  
Tables & Desks  
Meeting Essentials  
Personal Organization  
Ergonomics  
High Density Storage  
Storage & Filing  
Facilities  
Technology Furniture  
Art & Engineering  
K-12 Education  
SAFE Collection Addendum



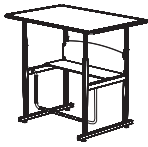

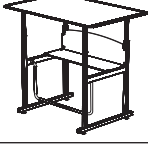
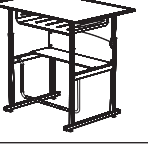

# AlphaBetter® 36" W Desks & Stool

Safco® Products marketing materials are designed to be used as sales tools for our Dealer network.

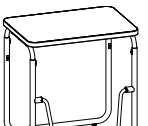
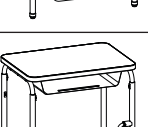

Model #	Description	Model #	List Price Ea.	List Carton Price	Quantity Per Carton	Actual Weight	S-Parcel Billable Weight	Carton Cube	Freight Class
<b>AlphaBetter® Desks &amp; Stools</b>									
 1206	AlphaBetter® Desk 36 x 24" Standard Top 36"W x 24"D x 26" - 42"H <b>Desktop Finish:</b> Beige-BE Steel Frame with Black Powder Coat Finish Patented Swinging Pendulum™ Footrest Bar	1206BE	878.00	878.00	1	51	77	7.09	110
 1207	AlphaBetter® Desk, with Book Box 36 x 24" Standard Top 36"W x 24"D x 26" - 42"H <b>Desktop Finish:</b> Beige-BE Steel Frame with Black Powder Coat Finish Patented Swinging Pendulum™ Footrest Bar	1207BE	1,086.00	1,086.00	1	59	77	7.09	110
 1208	AlphaBetter® Desk 36 x 24" Premium Top 36"W x 24"D x 26" - 42"H <b>Desktop Finish:</b> Gray-GR, Dry Erase-DE Steel Frame with Black Powder Coat Finish Patented Swinging Pendulum™ Footrest Bar	1208GR 1208DE	930.00	930.00	1	51	77	7.09	110
 1209	AlphaBetter® Desk, with Book Box 36 x 24" Premium Top 36"W x 24"D x 26" - 42"H <b>Desktop Finish:</b> Gray-GR, Dry Erase-DE Steel Frame with Black Powder Coat Finish Patented Swinging Pendulum™ Footrest Bar	1209GR 1209DE	1,142.00	1,142.00	1	58	77	7.09	110
 1205	AlphaBetter® Stool Seat Size: 13" Sq. Overall: 15¼" - 19¼"W x 21" - 35½"H <b>Seat Finish:</b> Beige-BE, Black-BL Steel Frame with Black Powder Coat Finish	1205BE 1205BL	432.00	432.00	1	23	34	3.14	125
 1212BL	AlphaBetter® Optional Book Box 22"W x 15"D x 4¼"H <b>Finish:</b> Black-BL	1212BL	196.00	196.00	1	8	15	1.26	250

# AlphaBetter® Desks 2.0

<b>AlphaBetter® Desks 2.0</b>									
 1221	Height-Adjustable Student Desk with Pendulum Bar 22-30" 27¾"W x 19¼"D x 22-30"H <b>Desktop Finish:</b> White Dry Erase Top-DE, Gray Nebula Top-GR <b>Leg Finish:</b> Cityscape Gray	1221DE 1221GR	560.00 516.00	560.00 516.00	1 1	31 31	35 35	1.76 1.76	070 070
 1222	Height-Adjustable Student Desk - Pendulum Bar - Book Box 27¾"W x 19¼"D x 22-30"H <b>Desktop Finish:</b> White Dry Erase Top-DE, Gray Nebula Top-GR <b>Leg Finish:</b> Cityscape Gray	1222DE 1222GR	643.00 629.00	643.00 629.00	1 1	37 37	43 43	2.11 2.11	070 070
 1223	Height-Adjustable Student Desk with Pendulum Bar 29-43" 27¾"W x 19¼"D x 29-43"H <b>Desktop Finish:</b> White Dry Erase Top-DE, Gray Nebula Top-GR <b>Leg Finish:</b> Cityscape Gray	1223DE 1223GR	602.00 588.00	602.00 588.00	1 1	34 34	38 38	2.1 2.1	070 070
 1224	Height-Adjustable Student Desk - Pendulum Bar - Book Box 27¾"W x 19¼"D x 29-43"H <b>Desktop Finish:</b> White Dry Erase Top-DE, Gray Nebula Top-GR <b>Leg Finish:</b> Cityscape Gray	1224DE 1224GR	685.00 671.00	685.00 671.00	1 1	40 40	46 46	2.52 2.52	070 070
 1210BL	Carpet Casters for AlphaBetter®, Set of 4, Black-BL Casters: 2½"H	1210BL	28.00	28.00	1	1.2	2	0.08	65
 1211BL	Hard floor Casters for AlphaBetter®, Set of 4, Black-BL Casters: 2½"H	1211BL	39.00	39.00	1	1.3	2	0.08	65

Office Suites  
Seating  
Tables & Desks  
Meeting Essentials  
Personal Organization  
Ergonomics  
High Density Storage  
Storage & Filing  
Facilities  
Technology Furniture  
Art & Engineering  
K-12 Education  
SAFE Collection Addendum



## Flip & Nest Desks

	Model #	Description	Model #	List Price Ea.*	List Carton Price	Quantity Per Carton	Actual Weight	S-Parcel Billable Weight	Carton Cube	Freight Class	
	<b>Flip and Nest Desks</b>										
	1226	Learn Nesting Trapezoid Desk 32 3/4"W x 22 1/4"D x 29 1/2"H Powder coat steel frame Finish: White Dry-Erase Top-DE, Pebbled Gray Top-GR Base Finish: Grey	1226DE 1226GR	664.00	664.00	1	31.1	37	4.15	125	
	1227	Learn Nesting Rectangle Desk 28"W x 22 1/4"D x 29 1/2"H Powder coat steel frame Finish: White Dry-Erase Top-DE, Pebbled Gray Top-GR Base Finish: Grey	1227DE 1227GR	636.00	636.00	1	35.4	41	3.16	125	

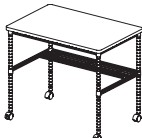

## Wire Desk

	<b>Wire Desk</b>										
	5203BL	Wire Desk Overall: 35 3/4"W x 24"D x 30 3/4"H Bottom Shelf Dimensions: 35"W x 6 1/4"D Finish: Black-BL	5203BL	245.00	245.00	1	46.4	47	3.64	175	

## Wood Organizers

	9422	Wood Adjustable Literature Organizer - 16 Compartment 19 1/2"W x 11 1/4"D x 21"H Finish: Gray-GR, Medium Oak-MO	9422GR 9422MO	217.00	217.00	1	24	24	0.65	85
	9423	Wood Adjustable Literature Organizer - 24 Compartment 39 3/4"W x 11 1/4"D x 16 1/4"H Finish: Gray-GR, Medium Oak-MO	9423GR 9423MO	273.00	273.00	1	41	41	1.24	85
	9424	Wood Adjustable Literature Organizer - 36 Compartment 39 3/4"W x 11 1/4"D x 24"H Finish: Gray-GR, Medium Oak-MO	9424GR 9424MO	331.00	331.00	1	52	52	1.62	85
	9494	Wood Adjustable Literature Organizer 32 Compartment/2 Drawer 39 3/4"W x 11 1/4"D x 25 1/4"H Finish: Gray-GR, Medium Oak-MO	9494GR 9494MO	383.00	383.00	1	70	70	1.96	85

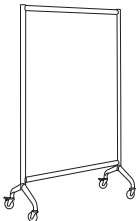
## Rumba™ Collaboration Screens & Whiteboard

	2014WBS	Rumba™ Screen 36"W x 54"H Full Whiteboard Screen Overall Size: 36"W x 16"D x 54"H	2014WBS	1,253.00	1,253.00	1	31	LTL	5.47	70
	2015WBS	Rumba™ Screen 42"W x 54"H Full Whiteboard Screen Overall Size: 42"W x 16"D x 54"H	2015WBS	1,319.00	1,319.00	1	38	LTL	6.3	70
	2016WBS	Rumba™ Screen 36"W x 66"H Full Whiteboard Screen Overall Size: 36"W x 16"D x 66"H	2016WBS	1,309.00	1,309.00	1	45	LTL	5.76	70
	2017WBS	Rumba™ Screen 42"W x 66"H Full Whiteboard Screen Overall Size: 42"W x 16"D x 66"H	2017WBS	1,381.00	1,381.00	1	41	LTL	6.69	70
	2008GR	Rumba™ Screen Eraser Tray	2008GR	46.00	46.00	1	1	1	0.08	100
	3909GR	Mobile Whiteboard, 30"x 64" - White Dry Erase Board Magnetic board, Cutout in board for easy marker storage Overall Size: 30"W x 24"D x 63 7/16"H	3909GR	1,709.00	1,709.00	1	80	LTL	-	70

# Learn Height-Adjustable Tables

Safco® Products marketing materials are designed to be used as sales tools for our Dealer network.

(Top + Coordinating Legs) Model #	Description	Model	List Price Ea.	List Carton Price	Quantity Per Carton	Actual Weight	S-Parcel Billable Weight	Carton Cube	Freight Class
<ul style="list-style-type: none"> <li>High Pressure Laminate</li> <li>3mm edge band</li> <li>Height adjustable legs, adjust in 1" increments</li> <li>Powder Coated Steel Legs</li> <li>Adjustable nylon base levelers</li> <li>Casters available - order separately</li> <li>Tops and bases are sold separately, be sure to order one of each</li> <li>Made in USA</li> </ul>									
	<b>REC4824</b> Rectangle Top - 48"W x 24"D	REC4824GYNAWG REC4824FUMPWG REC4824DRYEYG	449.00	449.00	1	42	LTL	-	70
	<b>Laminate:</b> Gray Nebula/Warm Gray-GYNAWG Fusion Maple/Warm Gray-FUMPWG White Dry Erase/Warm Gray-DRYEYG		494.00	494.00	1	42	LTL	-	70
	<b>REC6024</b> Rectangle Top - 60"W x 24"D	REC6024GYNAWG REC6024FUMPWG REC6024DRYEYG	526.00	526.00	1	54	LTL	-	125
	<b>Laminate:</b> Gray Nebula/Warm Gray-GYNAWG Fusion Maple/Warm Gray-FUMPWG White Dry Erase/Warm Gray-DRYEYG		578.00	578.00	1	54	LTL	-	125
	<b>REC6030</b> Rectangle Top - 60"W x 30"D	REC6030GYNAWG REC6030FUMPWG REC6030DRYEYG	578.00	578.00	1	66	LTL	-	70
	<b>Laminate:</b> Gray Nebula/Warm Gray-GYNAWG Fusion Maple/Warm Gray-FUMPWG White Dry Erase/Warm Gray-DRYEYG		775.00	775.00	1	66	LTL	-	70
	<b>REC6036</b> Rectangle Top - 60"W x 36"D	REC6036GYNAWG REC6036FUMPWG REC6036DRYEYG	757.00	757.00	1	84.5	LTL	-	70
	<b>Laminate:</b> Gray Nebula/Warm Gray-GYNAWG Fusion Maple/Warm Gray-FUMPWG White Dry Erase/Warm Gray-DRYEYG		833.00	833.00	1	84.5	LTL	-	70
	<b>REC7230</b> Rectangle Top - 72"W x 30"D	REC7230GYNAWG REC7230FUMPWG REC7230DRYEYG	680.00	680.00	1	77.5	LTL	-	70
	<b>Laminate:</b> Gray Nebula/Warm Gray-GYNAWG Fusion Maple/Warm Gray-FUMPWG White Dry Erase/Warm Gray-DRYEYG		747.00	747.00	1	77.5	LTL	-	70
	<b>REC7236</b> Rectangle Top - 72"W x 36"D	REC7236GYNAWG REC7236FUMPWG REC7236DRYEYG	897.00	897.00	1	102	LTL	-	70
	<b>Laminate:</b> Gray Nebula/Warm Gray-GYNAWG Fusion Maple/Warm Gray-FUMPWG White Dry Erase/Warm Gray-DRYEYG		986.00	986.00	1	102	LTL	-	70
	<b>HADJ18304GR</b> Height Adjustable 4-Leg Pack 18-30"	HADJ18304GR	439.00	439.00	1	18	LTL	-	70
	<b>HADJ29444GR</b> Height Adjustable 4-Leg Pack 29-44" <b>Leg Color:</b> Cityscape Gray	HADJ29444GR	481.00	481.00	1	23	LTL	-	70
	<b>WAV6030</b> Wave Top - 60"W x 30"D	WAV6030GYNAWG WAV6030FUMPWG WAV6030DRYEYG	680.00	680.00	1	65.2	LTL	-	70
	<b>Laminate:</b> Gray Nebula/Warm Gray-GYNAWG Fusion Maple/Warm Gray-FUMPWG White Dry Erase/Warm Gray-DRYEYG		748.00	748.00	1	65.2	LTL	-	70
	<b>HADJ18304GR</b> Height Adjustable 4-Leg Pack 18-30"	HADJ18304GR	439.00	439.00	1	18	LTL	-	70
	<b>HADJ29444GR</b> Height Adjustable 4-Leg Pack 29-44" <b>Leg Color:</b> Cityscape Gray	HADJ29444GR	481.00	481.00	1	23	LTL	-	70
	<b>YNG6030</b> Yinyang Top - 60"W x 30"D	YNG6030GYNAWG YNG6030FUMPWG YNG6030DRYEYG	707.00	707.00	1	51.3	LTL	-	70
	<b>Laminate:</b> Gray Nebula/Warm Gray-GYNAWG Fusion Maple/Warm Gray-FUMPWG White Dry Erase/Warm Gray-DRYEYG		775.00	775.00	1	51.3	LTL	-	70
	<b>HADJ18303GR</b> Height Adjustable 3-Leg Pack 18-30"	HADJ18303GR	329.00	329.00	1	12	LTL	-	85
	<b>HADJ29443GR</b> Height Adjustable 3-Leg Pack 29-44" <b>Leg Color:</b> Cityscape Gray	HADJ29443GR	363.00	363.00	1	18	LTL	-	85
	<b>HRND6030</b> Half Round Top - 60"W x 30"D	HRND6030GYNAWG HRND6030FUMPWG HRND6030DRYEYG	707.00	707.00	1	51.4	LTL	-	70
	<b>Laminate:</b> Gray Nebula/Warm Gray-GYNAWG Fusion Maple/Warm Gray-FUMPWG White Dry Erase/Warm Gray-DRYEYG		775.00	775.00	1	51.4	LTL	-	70
	<b>HADJ18303GR</b> Height Adjustable 3-Leg Pack 18-30"	HADJ18303GR	329.00	329.00	1	12	LTL	-	85
	<b>HADJ29443GR</b> Height Adjustable 3-Leg Pack 29-44" <b>Leg Color:</b> Cityscape Gray	HADJ29443GR	363.00	363.00	1	18	LTL	-	85
	<b>1210BL</b> Carpet Casters, Set of 4 Casters: 2½"H <b>Finish:</b> Black-BL	1210BL	28.00	28.00	1	1.2	2	0.08	65
	<b>1211BL</b> Hard floor Casters, Set of 4 Casters: 2½"H <b>Finish:</b> Black-BL	1211BL	39.00	39.00	1	1.3	2	0.08	65

- Available in sitting (29") or standing (42") heights
- Cast iron base with 3" diameter steel tube support (Black only) or Stainless Steel base with square tube support
- Quick and easy assembly
- TFL = 1" tops; HPL = 1 1/8" tops
- Optional 18" footing only available on cast iron base

- Available in either 1" Thermally Fused Laminate (TFL) or 1 1/8" High pressure Laminate (HPL) surfaces
- HPL edge Treatments: Knife Edge (HK), or T-Mold (HT) available in corporate edge colors see website
- **Designer Finishes:** Customer Specified Request form available. See page 11; use "H" suffix on model number when ordering

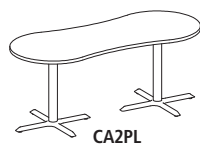

Model No.	Description	Wt.	TFL List Price "T" Suffix	HPL List Price HT or HK Suffix
<b>Bistro Dining-Height Models</b>				
CA2PL	72"W x 30"D x 29"H Peanut Table	75	2,023.00	2,382.00



Model No.	Description	Wt.	TFL List Price "T" Suffix	HPL List Price HT or HK Suffix
<b>Bistro Bar-Height Models</b>				
CA2PH	72"W x 30"D x 42"H Peanut Table	80	2,069.00	2,470.00

- Available in sitting (29") or standing (42") heights
- Stainless Steel base with square tube support
- Quick and easy assembly
- Four leveling glides integrated to underside of base

- Tables available in either Thermally Fused Laminate with standard T-Mold or High Pressure Laminate with your choice of 2 edge treatments
- HPL edge Treatments: Knife Edge (HK), or T-Mold (HT) available in corporate edge colors see page 10

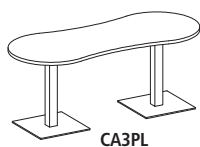

Model No.	Description	Wt.	TFL List Price "T" Suffix	HPL List Price HT or HK Suffix
<b>Bistro Sitting-Height Models - Stainless Steel base with square tube support</b>				
CA3PL	72"W x 30"D x 29"H Peanut Table	126	2,277.00	2,735.00

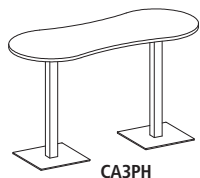

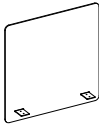
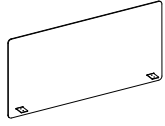

Model No.	Description	Wt.	TFL List Price "T" Suffix	HPL List Price HT or HK Suffix
<b>Bistro Standing-Height Models - Stainless Steel base with square tube support</b>				
CA3PH	72"W x 30"D x 42"H Peanut Table	132	2,598.00	3,248.00

Office Suites  
Seating  
Tables & Desks  
Meeting Essentials  
Personal Organization  
Ergonomics  
High Density Storage  
Storage & Filing  
Facilities  
Technology Furniture  
Art & Engineering  
K-12 Education

Model #	Description	Model #	List Price Ea.*	List Carton Price	Quantity Per Carton	Actual Weight	S-Parcel Billable Weight	Carton Cube	Freight Class
<b>Desktop Privacy &amp; Wellness Panels</b>									
	<b>7515FR</b> Desktop Privacy & Wellness Panel - Frosted 23½"W x 23½"H	7515FR	253.00	253.00	1	8	12	1.09	125
	<b>7515WH</b> Desktop Privacy & Wellness Panel - White 23½"W x 23½"H	7515WH	253.00	253.00	1	8	12	1.09	150
	<b>7516FR</b> Desktop Privacy & Wellness Panel - Frosted 47½"W x 23½"H	7516FR	392.00	392.00	1	16	23	2.17	125
	<b>7516WH</b> Desktop Privacy & Wellness Panel - White 47½"W x 23½"H	7516WH	392.00	392.00	1	16	23	2.17	150

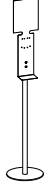
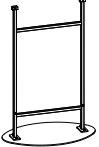
Hand Sanitizer Stand | Modular Guards | Temperature Stations

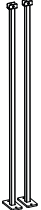
	<b>7512GR</b> Hand Sanitizer Stand 12"W x 61½"H Finish: Gray-GR	7512GR	252.00	252.00	1	18	18	1.47	250
	<b>7553BL</b> Modular Guard Mobile Tall Stand 27"W x 18"D x 39¼"H	7553BL	445.00	445.00	1	33	LTL	2.67	70
	<b>7555BL</b> Modular Guard Ganging Kit 1"W x 1"D x 1½"H	7555BL	70.00	70.00	1	1	LTL	0.1	70
	<b>7556BL</b> Modular Guard Counter Mount 2"W x 4"D x 7½"H	7556BL	165.00	165.00	1	4	LTL	0.25	70
	Note: Unit requires anchoring to surface or floor. Hardware not included, be sure to use correct mounting hardware per substrate.								
	<b>7557BL</b> Modular Guard Tall Floor Mount 2"W x 4"D x 39"H	7557BL	246.00	246.00	1	10	LTL	0.88	70
	Note: Unit requires anchoring to surface or floor. Hardware not included, be sure to use correct mounting hardware per substrate.								

Model No.	Page	Model No.	Page	Model No.	Page	Model No.	Page
10GA.....	111	1204.....	114, 257	1881.....	129	2984.....	204
195TKLS.....	141, 238	1205.....	114-115, 257-258	1907BL.....	117	2987BL.....	204
0412P06.....	171, 173, 225	1206.....	258	1908BL.....	117	2988BL.....	204
502TB.....	106	1206BE.....	115, 258	1921.....	116	2989BL.....	204
503TB.....	106	1207.....	258	1923.....	116	2990CZ.....	204
504STB.....	106	1207BE.....	115, 258	1925.....	116	2990PA.....	204
504TB.....	106	1208.....	115, 258	1927.....	116	2990PC.....	204
505SL.....	106	1209.....	115, 258	1929.....	116	2990RE.....	204
505STB.....	106	1210BL.....	98, 114-115, 257-258, 260	1930.....	113	2990WA.....	204
505TB.....	106	1211BL.....	98, 114-115, 257-258, 260	1931.....	113	3000.....	86, 255
505WL.....	106	1212.....	164-165	1933.....	113	3001.....	86, 255
506STB.....	106	1212BL.....	114-115, 257-258	1934.....	113	3005BV.....	86
506TB.....	106	1212P06.....	171, 173, 225	1938TG.....	117	3006BV.....	86
507STB.....	106	1214P06.....	225	1943.....	116	3019.....	99
507TB.....	106	1215P06.....	173, 225	1944.....	117	3020.....	99
508TB.....	106	1218.....	230	1950.....	116	3030.....	246
509STB.....	106	1219.....	232	1951.....	116	3043.....	247
510SL.....	106	1221.....	115, 258	1957.....	117	3045.....	247
510WL.....	106	1222.....	115, 258	1958.....	117	3079.....	246
0512P06.....	171, 173, 225	1223.....	115, 258	1959.....	117	3081.....	246
0515P06.....	173, 225	1224.....	115, 258	1964WH.....	117	3082.....	247
515SL.....	106	1226.....	116, 259	2005SL.....	259	3083.....	247
515WL.....	106	1227.....	116, 259	2008GR.....	121, 259	3084.....	246
520SL.....	106	1412P06.....	171, 173, 225	2014WBS.....	121, 259	3088.....	246
524MC.....	104	1415P06.....	173, 225	2015WBS.....	121, 259	3090.....	246
525SL.....	106	1505TL.....	42	2016WBS.....	121, 259	3091.....	246
605.....	105	1515P06.....	173, 225	2017WBS.....	121, 259	3116BL.....	137
610W.....	105	1612P06.....	171, 173, 225	2059BL.....	111	3127BL.....	137
0612P06.....	171, 173, 225	1615P06.....	173, 225	2060BL.....	111	3128BL.....	137
615S.....	105	1700.....	184	2069BL.....	111	3129BL.....	137
615W.....	105	1701.....	184	2078BL.....	111	3155BL.....	137
650S.....	105	1702.....	184	2086.....	97	3167BL.....	137
650SW.....	105	1703.....	184	2105.....	144	3170BL.....	139
680W.....	105	1704.....	184	2106.....	144	3171BL.....	139
690W.....	105	1705.....	184	2110BL.....	145	3172BL.....	139
0712P06.....	171, 173, 225	1706.....	184	2111BL.....	145	3185BL.....	139
787.....	237	1714.....	81	2120BL.....	144	3230BL.....	134
788.....	237	1715.....	81	2129BL.....	144	3231BL.....	134
789.....	237	1716.....	81	2144BL.....	143	3233BL.....	134
0812P06.....	171, 173, 225	1718.....	81	2150BL.....	141	3240BL.....	135
0912P06.....	171, 173, 225	1719.....	81	2159BL.....	134, 141	3241BL.....	135
0915P06.....	173, 225	1720NA.....	81	2160BL.....	134	3242BL.....	135
922VEL.....	173, 227, 232	1721NA.....	81	2161BL.....	134, 141	3243BL.....	135
945.....	118	1730MRL2.....	83	2162BL.....	136	3244BL.....	135
946.....	118	1730RESFEET4PK.....	83	2164BL.....	133	3250.....	164-165
947.....	118	1731MRL2.....	83	2169BL.....	136	3250BL.....	134
948.....	118	1731RESFEET4PK.....	83	2170.....	172	3251BL.....	134
950.....	118	1732MRL2.....	83	2170BL.....	136	3252BL.....	134
1001.....	143	1732RESFEET4PK.....	83	2175.....	141	3253BL.....	135
1009.....	143	1850.....	129	2176.....	141	3254.....	135
1012P06.....	171, 173, 225	1855BL.....	130	2180.....	142	3255.....	135
1015P06.....	173, 225	1856BL.....	130	2191WH.....	142	3256BL.....	135
1017.....	143	1857.....	129	2192WH.....	142	3257BL.....	135
1018.....	143	1859.....	129	2193WH.....	142	3258.....	135
1019WH.....	143	1860GR.....	130	2254BL.....	90, 111	3259BL.....	135
1112P06.....	171, 173, 225	1861GR.....	130	2255BL.....	90, 111	3260BL.....	136
1114P06.....	225	1862.....	129	2480DSP.....	239	3261BL.....	136
1115P06.....	173, 225	1870GR.....	130	2944BL.....	203	3262BL.....	136
1201BE.....	114, 257	1871GR.....	130	2981.....	204	3263BL.....	136
1202BE.....	114, 257	1872BL.....	130	2982.....	204	3264BL.....	136
1203.....	114, 257	1876.....	131	2983.....	204	3265BL.....	136

Office Suites  
Seating  
Tables & Desks  
Meeting Essentials  
Personal Organization  
Ergonomics  
High Density Storage  
Storage & Filing  
Facilities  
Technology Furniture  
Art & Engineering  
Education  
SAFE Collection Addendum

Model No.	Page	Model No.	Page	Model No.	Page	Model No.	Page
3266	136	3914CL	253	4175BL	140	4753	87, 254
3271	136	3915MA	253	4176BL	140	4755	87, 254
3272BL	136	3916MA	253	4182	65	4756	87, 254
3274BL	124	3917	253	4183	63	4757	87, 254
3275BL	124	3918	253	4184	79	4760	87, 254
3285	132	3921	250	4185	80	4761	87, 254
3286	132	3922	250	4187	64	4897	246
3290BL	124	3923	250	4188	80	4899	246
3291BL	124	3924	250	4190SL	69, 80	4931LG	247
3292BL	124	3925	250	4191NC	126	4935LG	247
3293BL	124	3926	251	4199BL	79	4969LG	245
3391	76	3927	251	4200	127	4970LG	245
3394	75	3928	251	4201	127	4971LG	245
3395	75	3929	251	4202	127	4972LG	245
3396BL	75	3930	251	4203SL	127	4973LG	245
3397	74	3931	252	4205SL	127	4974LG	245
3399BL	74-76	3932	252	4224BL	128	4975	243-244
3401	75	3933	252	4225BL	128	4977	243-244
3406	75	3934	252	4227BL	128	4979	243-244
3430BL	84	3935	252	4229BL	128	4980	243
3431BL	84	3948	241	4231	138	4981	243
3432BL	84	3951	241	4232	138	4983	243
3433BL	84	3952	241	4232BL	138	4986	243-244
3434BL	83	3953	241	4233	138	4994	243-244
3436BL	83	3957	241	4233GR	138	4995	243-244
3437BL	84	3962	241	4234CL	138	4996	243-244
3438BL	84	3962GR	241	4237	138	4997	243-244
3442	74	3965MO	241	4241BL	126	4998	243-244
3490	77	4017	62	4255	127	4999	243-244
3491	77	4021	61	4256	126	5006	242
3492	77	4022	59	4257	127	5010	242
3495BL	74	4039	60	4258BL	138	5016	242
3496BL	77	4049NC	209	4259BL	138	5023AH	245
3500BL	77	4050	209	4263WH	126	5026	242
3502	76	4053NC	210	4264WH	126	5030	242
3503	76	4054BL	209	4265WH	126	5038	242
3504	76	4055NC	209	4271	78	5039	242
3505	76	4061	209	4273	78	5040	242
3590BL	77	4062	209	4275	78	5041	242
3591BL	77	4063	210	4287	79	5056	242
3592BL	77	4069	209	4289BLSL	80	5059	242
3603BL	133	4070	209	4290	69	5060	242
3604BL	134	4071	209	4291	69	5117	85
3611BL	121	4072	210	4292	69	5120	85
3612BL	121	4082	65	4295	70	5124	144
3680DSP	239	4083	63	4296	70	5130	85
3836A3	169	4086R	209	4311	242	5131	85
3842A3	169	4117BL	128	4312	242	5132	74, 79, 84-85, 256
3848A3	169	4118BL	128	4314	79	5138	74-75, 84-85, 256
3901	248, 253	4128CH	188	4315	79	5143	85
3902	248, 253	4134SL	184	4321	189	5144	85
3903	248, 253	4139CH	188	4322	189	5201	193
3904	248, 253	4158CH	139	4323	189	5202WH	131, 194
3905	248, 253	4160	127	4325	189	5203BL	116, 259
3906	249, 253	4161	127	4331	188	5206	131
3907	249, 253	4162	127	4360	80	5207	131
3908	248-249, 253	4163	126	4361	80	5208	131
3909GR	121, 259	4166	128	4362	80	5209WH	131, 194
3911CL	253	4167	128	4368	80	5211BL	195
3912CL	253	4168	126	4750	87, 254	5212BL	195
3913CL	253	4173BL	128	4751	87, 254	5213BL	195

Office Suites  
Seating  
Tables & Desks  
Meeting Essentials  
Personal Organization  
Ergonomics  
High Density Storage  
Storage & Filing  
Facilities  
Technology Furniture  
Art & Engineering  
K-12 Education



Model No.	Page	Model No.	Page	Model No.	Page	Model No.	Page
5214BL	195	5508WHNA	120	6402BL	127	7736	240
5215BL	195	5509WHNA	120	6403BL	127	7736A	240
5235GR	210	5510WHNA	120	6461BL	189	7736B	240
5236GR	210	5511	118	6551	245	7737	240
5238BL	210	5512	118	6552	245	7737A	240
5239BL	210	5513	118	6553	245	7737B	240
5241BL	207	5516	182	6603	84, 256	7739	240
5242BL	207	5518	182	6604	84, 256	7739A	240
5242DLH	103	5519	182	6605	84, 256	7739B	240
5242DSLH	103	5520	182	6606	84, 256	7749	211
5243BL	207	5522	182	6660	84, 256	7750	211
5244BL	206	5523	182	6661	84	7751	211
5245BL	206	5524	182	6664	83	7752	211
5246BL	206	5525	182	6665	83	7753	211
5247BL	206	5526	182	6666	83, 256	7756	211
5248CLH	103	5527	182	6668	83, 256	7765	211
5248CSLH	103	5528	182	6669	83	7766	211
5248DLH	103	5529	182	6680	85	7770	211
5248DSLH	103	5532	183	6683	85	7825	73
5260	206	5577BL	189	6689BL	74	7826	73
5261	206	5578BL	189	6803	61	7827	73
5276BL	207	5579BL	189	6804	59	7829BL	73
5277BL	193	5580BL	188	6805	59	8121	82, 255
5278BL	193	5600CL	185	6806	62	8122	82, 255
5283	207	5601CL	186	6807	61	8123	82, 255
5285	207	5602CL	185	6815	62	8124	82, 255
5286	207	5603CL	185	6815BL	62	8336A3	168
5287	207	5604CL	186	6820BL	61	8336B3	168
5288	207	5605CL	185	6827	72, 74	8342A3	168, 172
5289	207	5606CL	185	6828	72, 79	8342B3	168
5290	207	5651BL	139	6829	72, 79	8348A3	168
5291	207	5652BL	139	6830	71, 74	8348B3	168
5292	207	5653BL	139	6912	85	8510GRCL	121
5293	207	5665CL	187	6950BL	85	8511	121
5294	207	5666CL	187	7013	74	8693B	241
5295	207	5667CL	187	7014	75	8694B	241
5296	207	5668CL	187	7084BL	74	8696B	241
5333BL	193	5671CL	187	7111	190	8697B	241
5335BL	193	5698CL	186	7121	190	8912	123
5336BL	193	6236A3	168	7131	190	8915	124
5337BL	193	6236B3	168	7152BL	146	8918	123
5338BL	193	6242A3	168	7153BL	146	8919	123
5339BL	193	6242B3	168	7154BL	146	8921	124
5342DLH	104	6244BL	206	7170	192	8922BL	123
5342DSLH	104	6245BL	206	7171	192	8932BL	122
5348CLH	104	6246BL	206	7173	192	8943BL	122
5348CSLH	104	6247BL	206	7174	192	8945BL	122
5348DLH	104	6248A3	168	7512GR	262	8953	125
5348DSLH	104	6248B3	168	7515FR	262	8962	125
5350BL	194	6252	208	7515WH	262	8963BL	125
5353BL	195	6253	208	7516FR	262	8964BL	125
5357SA	193	6254	208	7516WH	262	8966	125
5358SA	193	6255	208	7553BL	262	9200BL	190
5361	194	6256	208	7555BL	262	9211	190
5362	194	6265	208	7556BL	262	9221	190
5363	194	6266	208	7557BL	262	9231	190
5364	194	6267	208	7732	240	9241	190
5370BL	195	6268	208	7732A	240	9264GR	190
5373BL	195	6269	208	7734	240	9311	191
5390	194	6270	208	7734A	240	9321	191
5393	120	6401BL	127	7734B	240	9331	191

Office Suites  
Seating  
Tables & Desks  
Meeting Essentials  
Personal Organization  
Ergonomics  
High Density Storage  
Storage & Filing  
Facilities  
Technology Furniture  
Art & Engineering  
K-12 Education  
SAFE Collection Addendum



Model No.	Page	Model No.	Page	Model No.	Page	Model No.	Page
9371BL.....	199	9718BL.....	202	83483.....	168	3302416.....	231, 235
9372BL.....	199	9740BL.....	202	90145.....	173, 227, 232	3302420.....	235
9401MO.....	191	9790BL.....	201	90154.....	227	3303016.....	231, 235
9402MO.....	191	9794BL.....	203	90155.....	227	3303020.....	235
9403MO.....	191	9798BL.....	203	90208.....	146	3303616.....	231, 235
9419.....	132	9799BL.....	201	90225.....	231	3303620.....	235
9420.....	132	9871.....	196	92311.....	144	3304816.....	231, 235
9422.....	191, 259	9875.....	196	242229.....	48	3304820.....	235
9423.....	191, 259	9893.....	196	243029.....	48	3305416.....	231, 235
9424.....	191, 259	9895.....	196	243629.....	48	3305420.....	235
9430BL.....	133	9901.....	198	244829.....	48	3306016.....	231, 235
9431BL.....	133	9901SS.....	198	246029.....	48	3306020.....	235
9432BL.....	133	9902.....	198	247229.....	48	3312416.....	235
9447.....	205	9903.....	198	350117.....	238	3312420.....	235
9448.....	205	9920.....	196	350142.....	238	3313016.....	235
9449.....	205	9921.....	196	350150.....	238	3313020.....	235
9450.....	205	9922.....	198	350151.....	238	3313616.....	235
9470.....	200	9923.....	198	350152.....	238	3313620.....	235
9471.....	200	9924.....	198	350173.....	238	3322421.....	235
9472.....	200	9925.....	198	350181.....	238	3323021.....	235
9473.....	200	9926.....	198	350212.....	231, 235	3323621.....	235
9474.....	200	9927BB.....	203	350213L.....	231, 235	3324821.....	235
9475.....	200	9928BB.....	203	350213R.....	231, 235	3326021.....	235
9476.....	200	9929BL.....	203	350214.....	231, 235	3332416.....	236
9477.....	200	9931SS.....	203	350215.....	231, 235	3332420.....	236
9478.....	200	9932BL.....	201	350216.....	235	3333016.....	236
9485BL.....	200	9933BL.....	201	350217.....	237	3333020.....	236
9486BL.....	200	9934BL.....	201	350218.....	235	3333616.....	236
9494.....	191, 259	9935BL.....	201	350220.....	231, 238	3333620.....	236
9550BL.....	205	9940BL.....	201	350318.....	235	3352414.....	237
9551BL.....	205	9941SS.....	203	350320L.....	235	3353014.....	237
9552BL.....	205	9942SS.....	203	350320R.....	235	3353614.....	237
9553BL.....	205	9968BL.....	197	350321L.....	238	3402430.....	231, 236
9560.....	205	9969CH.....	197	350321R.....	238	3402436.....	236
9560BL.....	205	19400.....	41	350325L.....	234-235	3403030.....	231, 236-237
9560CZ.....	205	24801S.....	239	350325R.....	235	3403036.....	236
9560PA.....	205	31124.....	234	350327L.....	238	3403630.....	231, 236
9560PC.....	205	31148.....	234	350327R.....	238	3403636.....	236-237
9560RE.....	205	31172.....	234	350440.....	239	3404830.....	231, 236
9560WA.....	205	36801S.....	239	350445.....	239	3404836.....	236
9604.....	202	38363.....	169	350450.....	239	3405430.....	236
9610CH.....	202	38423.....	169	350460.....	239	3405436.....	236
9616BL.....	202	38483.....	169	350465.....	239	3406030.....	231, 236
9618CH.....	202	49263.....	105, 141	350470.....	239	3406036.....	236
9632BU.....	203	49264.....	105, 141	350480.....	239	3407130.....	236
9636.....	199	49265.....	105, 141	350485.....	239	3407230.....	231, 236
9639.....	199	50016.....	242	350490.....	239	3407236.....	236
9651.....	205	50026.....	242	773096.....	112	3409030.....	231, 236
9652.....	205	50036.....	242	911196R.....	169	3409036.....	236
9668.....	196	50046.....	242	911785.....	173, 227, 232	3434830.....	237
9669.....	184, 196	50056.....	242	911884.....	227	3434836.....	237
9677NC.....	197	52224.....	103	912089R.....	168, 172	5222448H.....	103
9685SS.....	199	52230.....	103	3202460.....	231, 235	5222454H.....	103
9686SS.....	199	53224.....	103	3202472.....	231, 235	5222460H.....	103
9687SS.....	199	53230.....	103	3202484.....	231, 235	5222466H.....	103
9695.....	196	62363.....	168	3203060.....	231, 235	5222472H.....	103
9696BL.....	201	62483.....	168	3203072.....	231, 235	5223048H.....	103
9698BL.....	201	71301.....	146	3203084.....	231, 235	5223054H.....	103
9710.....	198	71491.....	146	3203660.....	231, 235	5223060H.....	103
9716BL.....	202	83363.....	168	3203672.....	231, 235	5223066H.....	103
9717BL.....	202	83423.....	168	3203684.....	231, 235	5223072H.....	103

SAFE Collection Addendum K-12 Education Engineering Art & Technology Furniture Facilities Storage & Filing High Density Storage Ergonomics Personal Organization Meeting Essentials Tables & Desks Seating Office Suites

Model No.	Page	Model No.	Page	Model No.	Page	Model No.	Page
5322448H.....	104	ARC2472CP .....	176	ARCB30726A.....	174	C343R6.....	40
5322454H.....	104	ARC2472EP .....	177	ARCB30726EA.....	174	C483L .....	41
5322460H.....	104	ARC2472WCS.....	176	ARCB30726ES.....	174	C483R.....	41
5322466H.....	104	ARC2482BTB.....	176	ARCB30726S.....	174	C515.....	39
5322472H.....	104	ARC2482CP .....	176	ARCB30827A.....	174	C523.....	39
5323048H.....	104	ARC2482EP .....	177	ARCB30827EA.....	174	C542.....	38
5323054H.....	104	ARC2482WCS.....	176	ARCB30827ES.....	174	C552.....	38
5323060H.....	104	ARC2493BTB.....	176	ARCB30827S.....	174	C583.....	38
5323066H.....	104	ARC2493CP .....	176	ARD6630.....	12	C593.....	38
5323072H.....	104	ARC2493EP .....	177	ARD7236.....	12, 17	C625.....	40
220000075.....	87, 254	ARC2493WCS.....	176	ARDH7236.....	13	C627.....	40
220000076.....	87, 254	ARC3015ROD105.....	175	ARDTC.....	17	C673.....	40
920000462.....	181	ARC3015ROD120.....	175	ASC.....	16	C685.....	40
A35CH5.....	161	ARC3015ROHF.....	175	ASC1P.....	56	C743.....	42
A7737.....	238	ARC3015ROSLF.....	175	ASC1U.....	56	C745.....	42
AB3S36.....	16	ARC3015RS.....	175	ASC2P.....	56	C746.....	42
AB5S36.....	16	ARC3015SLF.....	175	ASC2U.....	56	C747.....	42
ABD7242.....	12	ARC3072BTB.....	176	ASC3P.....	56	C763.....	42
ABDH7242.....	13	ARC3072CP .....	176	ASC3U.....	56	C765.....	42
ABSP.....	15, 23	ARC3072EP.....	177	ASC4P.....	58	C766.....	42
ABSPT.....	15, 23	ARC3072WCS.....	176	ASC4U.....	58	C767.....	42
ABTDS72.....	12	ARC3082BTB.....	176	ASC5P.....	57	C773.....	42
ACASTK.....	230	ARC3082CP .....	176	ASC5U.....	57	C775.....	42
ACB4224.....	13	ARC3082EP .....	177	ASC6P.....	57	C777.....	42
ACD.....	15, 21, 30	ARC3082WCS.....	176	ASC6U.....	57	C863.....	42
ACD7224.....	12	ARC3093BTB.....	176	ASC7P.....	58	C865.....	42
ACDS30.....	15, 21	ARC3093CP .....	176	ASC7U.....	58	C866.....	42
ACLF36.....	14	ARC3093EP .....	177	AT56.....	13	C867.....	42
ACTB6.....	17	ARC3093WCS.....	176	AT58.....	13	C1131.....	38
ACTB8.....	17	ARC24726A.....	174	AWG72.....	15	C1133.....	38
ACTB10.....	17	ARC24726EA.....	174	AWMK.....	161	C1136.....	38
ACTB12.....	17	ARC24726ES.....	174	C36A.....	36	C1141.....	38
ACTB18.....	17	ARC24726S.....	174	C36T.....	39	C1142.....	39
ACTR42.....	17	ARC24827A.....	174	C36TR.....	39	C1143.....	38
AEC72L.....	14	ARC24827EA.....	174	C42A.....	36	C1144.....	39
AEC72R.....	14	ARC24827ES.....	174	C48A.....	36	C1145.....	39
AFF20.....	14	ARC24827S.....	174	C48T.....	39	C1146.....	38
AFF26.....	14	ARC24938A.....	174	C48TR.....	39	C1151.....	38
AFLF36.....	14	ARC24938EA.....	174	C88MKEYH.....	43	C1152.....	39
AFTP72.....	16	ARC24938ES.....	174	C281N.....	36	C1153.....	38
AGDC.....	16	ARC24938S.....	174	C281S.....	35	C1154.....	39
AHG72.....	15	ARC30726A.....	174	C281T.....	35	C1155.....	39
AHPM.....	16	ARC30726EA.....	174	C282N.....	36	C1156.....	38
AHW72.....	15	ARC30726ES.....	174	C282S.....	35	C1161.....	38
ALC.....	17	ARC30726S.....	174	C282T.....	35	C1162.....	39
ALCT.....	17	ARC30827A.....	174	C283N.....	36	C1163.....	38
APBBF20.....	14	ARC30827EA.....	174	C283S.....	35	C1164.....	39
APBBF26.....	14	ARC30827ES.....	174	C283T.....	35	C1165.....	39
APED1.....	229	ARC30827S.....	174	C292S.....	36	C1166.....	38
APST.....	16	ARC30938A.....	174	C293S.....	36	C1171.....	38
APT7236.....	14	ARC30938EA.....	174	C313L1.....	40	C1172.....	39
AR4224.....	13	ARC30938ES.....	174	C313L3.....	40	C1173.....	38
ARC12CB.....	176	ARC30938S.....	174	C313L6.....	40	C1174.....	39
ARC15CB.....	176	ARCB24726A.....	174	C313R1.....	40	C1175.....	39
ARC2412ROD105.....	175	ARCB24726EA.....	174	C313R3.....	40	C1176.....	38
ARC2412ROD120.....	175	ARCB24726ES.....	174	C313R6.....	40	C1331.....	33
ARC2412ROHF.....	175	ARCB24726S.....	174	C343L1.....	40	C1333.....	33
ARC2412ROSLF.....	175	ARCB24827A.....	174	C343L3.....	40	C1336.....	33
ARC2412RS.....	175	ARCB24827EA.....	174	C343L6.....	40	C1341.....	33
ARC2412SLF.....	175	ARCB24827ES.....	174	C343R1.....	40	C1342.....	34
ARC2472BTB.....	176	ARCB24827S.....	174	C343R3.....	40	C1343.....	33

Office Suites  
Seating  
Tables & Desks  
Meeting Essentials  
Personal Organization  
Ergonomics  
High Density Storage  
Storage & Filing  
Facilities  
Technology Furniture  
Art & Engineering  
K-12 Education  
SAFE Collection Addendum

Model No.	Page	Model No.	Page	Model No.	Page	Model No.	Page
C1344	34	C2423	37	CA30RHS	102	CS2RS30	44
C1345	34	C2426	36	CA30RLB	101	CS2RS78	44
C1351	33	C2431	37	CA30RLS	102	CST2	45
C1352	34	C2433	37	CA30SHB	101	CST3	45
C1353	33	C2436	36	CA30SHS	102	CST4	45
C1354	34	C2441	37	CA30SLB	101	CST5	46
C1355	34	C2443	37	CA30SLS	102	CST7	46
C1356	33	C2446	36	CA36RHB	101	CST8	45
C1361	33	C2451	37	CA36RHS	102	CST9	46
C1362	34	C2453	37	CA36RLB	101	CST10	47
C1363	33	C2456	36	CA36RLS	102	CST14	47
C1364	34	C2461	37	CA36SHB	101	CST24	47
C1365	34	C2463	37	CA36SHS	102	CST25	44
C1366	33	C2466	36	CA36SLB	101	CST26	44
C1371	33	C2471	37	CA36SLS	102	CST27	44
C1372	34	C2473	37	CA42RHB	101	CTC72	107
C1373	33	C2476	36	CA42RHS	102	CTC84	107
C1374	34	C2481	37	CA42RLB	101	CTC96	107
C1375	34	C2483	37	CA42RLS	102	CTC120	107
C1376	33	C2486	36	CAFR18B	101	CTMB	109
C1651	34	C2501	37	CC01	180	CTRND	107
C1652	34	C2503	37	CC06	180	CTW72AP	107
C1653	34	C2506	37	CC08	181	CTW72SP	107
C1654	34	C2511	37	CC10	181	CTW84SP	107
C1655	34	C2513	37	CC11	181	CTWP	107
C1656	34	C2516	37	CCL18C	181	D09GS03	171, 173
C1661	34	C2521	37	CCL36C	181	D09GS10	171, 173
C1662	34	C2523	37	CCTK	181	EC48FB	110
C1663	34	C2526	37	CCUC	180	EC48FJB	110
C1664	34	C2531	37	CHA	100	EC48FJS	110
C1665	34	C2533	37	CHA29TR	100	EC48FS	110
C1671	34	C2536	37	CHA29X	100	EC48UB	110
C1672	34	C2541	37	CHA42TR	100	EC48UDB	110
C1673	34	C2543	37	CHA42X	100	EC54FB	110
C1674	34	C2546	37	CHARND30	100	EC54FS	110
C1675	34	C2551	37	CHARND36	100	EC60FB	110
C1676	34	C2553	37	CHARND3029TR	100	EC60FDB	110
C1951	35	C2556	37	CHARND3029X	100	EC60FDS	110
C1952	35	C2561	37	CHARND3042TR	100	EC60FJB	110
C1953	35	C2563	37	CHARND3042X	100	EC60FJS	110
C1954	35	C2566	37	CHARND3629TR	100	EC60FS	110
C1955	35	C2571	37	CHARND3629X	100	EC60UB	110
C1956	35	C2573	37	CHARND3642TR	100	EC60UDB	110
C1961	35	C2576	37	CHARND3642X	100	EC66FB	110
C1962	35	C2581	37	CHASQ30	100	EC66FS	110
C1963	35	C2583	37	CHASQ36	100	EC66UB	110
C1964	35	C7421	42	CHASQ3029TR	100	EC72FB	110
C1965	35	C7621	42	CHASQ3029X	100	EC72FDB	110
C1971	35	C7721	42	CHASQ3042TR	100	EC72FDS	110
C1972	35	C8621	42	CHASQ3042X	100	EC72FJB	110
C1973	35	C8824B	43	CHASQ3629TR	100	EC72FJS	110
C1974	35	C8824F	43	CHASQ3629X	100	EC72FS	110
C1975	35	C8824M	43	CHASQ3642TR	100	EC72UB	110
C1976	35	C8830B	43	CHASQ3642X	100	EC72UDB	110
C2401	37	C8830F	43	CL15	41	ECB	110
C2403	37	C8830M	43	CL24	41	ECH	110
C2406	36	CA2PH	101, 261	CL30	41	ECS	110
C2411	37	CA2PL	101, 261	CLCK	43	EF24CS	159, 167
C2413	37	CA3PH	102, 261	CMT12	107	EF30CS	159, 167
C2416	36	CA3PL	102, 261	CMT14	107	EF30RS	160
C2421	37	CA30RHB	101	CS2RC	44	EF36CS	159, 167

Office Suites  
Seating  
Tables & Desks  
Meeting Essentials  
Personal Organization  
Ergonomics  
High Density Storage  
Storage & Filing  
Facilities  
Technology Furniture  
Art & Engineering  
K-12 Education  
SAFE Collection Addendum

Model No.	Page	Model No.	Page	Model No.	Page	Model No.	Page
EF36RS.....	160	EF2443L.....	157	EF3612S.....	158	EF4809S.....	158
EF42CS.....	159, 167	EF2443OP.....	157	EF3612S18GA.....	159	EF4809U.....	158
EF42RS.....	160	EF2465BP.....	161	EF3612U.....	158	EF4811SSB.....	160, 167
EF48CS.....	159, 167	EF2465CP.....	161	EF3612U18GA.....	159	EF4811SSPT.....	160
EF48RS.....	160	EF2465L.....	157	EF3615S.....	158	EF4812S.....	158
EF0976L.....	157	EF2465OP.....	157	EF3615S18GA.....	159	EF4812S18GA.....	159
EF0986L.....	157	EF2476CP.....	161	EF3615U.....	158	EF4812U.....	158
EF0986OP.....	157	EF2476L.....	157	EF3615U18GA.....	159	EF4812U18GA.....	159
EF1243L.....	157	EF2476OP.....	157	EF3618S.....	158	EF4815S.....	158
EF1243OP.....	157	EF2476T.....	157	EF3618S18GA.....	159	EF4815U.....	158
EF1265L.....	157	EF2486CP.....	161	EF3618U.....	158	EF4815U18GA.....	159
EF1265OP.....	157	EF2486L.....	157	EF3618U18GA.....	159, 167	EF4818S.....	158
EF1265T.....	157	EF2486OP.....	157	EF3624S.....	158	EF4818U.....	158
EF1276L.....	157	EF2486T.....	157	EF3624S18GA.....	159	EF4818U18GA.....	159, 167
EF1276OP.....	157	EF2497CP.....	161	EF3624U.....	158	EF4824S.....	158
EF1276T.....	157	EF2497L.....	157	EF3624U18GA.....	159	EF4824U.....	158
EF1286L.....	157	EF2497OP.....	157	EF3630S.....	158	EF4824U18GA.....	159
EF1286OP.....	157	EF2497T.....	157	EF3630U.....	158	EF4830S.....	158
EF1286T.....	157	EF3002KP.....	160	EF3630U18GA.....	159	EF4830U.....	158
EF1297L.....	157	EF3006KP.....	160	EF3636U18GA.....	159, 167	EF4830U18GA.....	159
EF1297OP.....	157	EF3011SSB.....	160, 167	EF3643BP.....	161	EF4836U18GA.....	159, 167
EF1543L.....	157	EF3011SSPT.....	160	EF3643CP.....	161	EF4843BP.....	161
EF1543OP.....	157	EF3012S.....	158	EF3665BP.....	161	EF4843CP.....	161
EF1543T.....	157	EF3012U.....	158	EF3665CP.....	161	EF4865BP.....	161
EF1565L.....	157	EF3012U18GA.....	159	EF3676BP.....	161	EF4865CP.....	161
EF1565OP.....	157	EF3015S.....	158	EF3676CP.....	161	EF4876BP.....	161
EF1576L.....	157	EF3015U.....	158	EF3686BP.....	161	EF4876CP.....	161
EF1576OP.....	157	EF3018U.....	158	EF3686CP.....	161	EF4886BP.....	161
EF1576T.....	157	EF3018U18GA.....	159, 167	EF3697BP.....	161	EF4886CP.....	161
EF1586L.....	157	EF3024S.....	158	EF3697CP.....	161	EF4897BP.....	161
EF1586OP.....	157	EF3024U.....	158	EF4202KP.....	160	EF4897CP.....	161
EF1586T.....	157	EF3024U18GA.....	159	EF4206KP.....	160	EFL2409656S.....	153
EF1597L.....	157	EF3030S.....	158	EF4209U.....	158	EFL2409767S.....	154
EF1597OP.....	157	EF3030U.....	158	EF4211SSB.....	160, 167	EFL2409868S.....	155
EF1597T.....	157	EF3030U18GA.....	159	EF4211SSPT.....	160	EFL2409979S.....	156
EF1843L.....	157	EF3036U18GA.....	159, 167	EF4212S.....	158	EFL2412433S.....	152
EF1843OP.....	157	EF3043CP.....	161	EF4212U.....	158	EFL2412656S.....	153
EF1843T.....	157	EF3043L.....	157	EF4215S.....	158	EFL2412767S.....	154
EF1865L.....	157	EF3065BP.....	161	EF4215S18GA.....	159	EFL2412868S.....	155
EF1865OP.....	157	EF3065CP.....	161	EF4215U.....	158	EFL2412979S.....	156
EF1865T.....	157	EF3065L.....	157	EF4215U18GA.....	159	EFL2415433S.....	152
EF1876L.....	157	EF3065OP.....	157	EF4218U.....	158	EFL2415656S.....	153
EF1876OP.....	157	EF3076BP.....	161	EF4218U18GA.....	159, 167	EFL2415767S.....	154
EF1876T.....	157	EF3076CP.....	161	EF4224S.....	158	EFL2415868S.....	155
EF1886L.....	157	EF3076L.....	157	EF4224U.....	158	EFL2415979S.....	156
EF1886OP.....	157	EF3076OP.....	157	EF4224U18GA.....	159	EFL2418433S.....	152
EF1886T.....	157	EF3086BP.....	161	EF4230S.....	158	EFL2418656S.....	153
EF1897L.....	157	EF3086CP.....	161	EF4230U.....	158	EFL2418767S.....	154
EF1897OP.....	157	EF3086L.....	157	EF4230U18GA.....	159	EFL2418868S.....	155
EF1897T.....	157	EF3086OP.....	157	EF4236U18GA.....	159, 167	EFL2418979S.....	156
EF2411SSB.....	160, 167	EF3097BP.....	161	EF4243CP.....	161	EFL2424433S.....	152
EF2411SSPT.....	160	EF3097CP.....	161	EF4265BP.....	161	EFL2424656S.....	153
EF2412S.....	158	EF3097L.....	157	EF4265CP.....	161	EFL2424767S.....	154
EF2412U.....	158	EF3097OP.....	157	EF4276BP.....	161	EFL2424868S.....	155
EF2415S.....	158	EF3097T.....	157	EF4276CP.....	161	EFL2424979S.....	156
EF2415U.....	158	EF3602KP.....	160	EF4286BP.....	161	EFL2430433S.....	152
EF2418U.....	158	EF3606KP.....	160	EF4286CP.....	161	EFL2430656S.....	153
EF2424S.....	158	EF3609S.....	158	EF4297BP.....	161	EFL2430767S.....	154
EF2424U.....	158	EF3609U.....	158	EF4297CP.....	161	EFL2430868S.....	155
EF2430U.....	158	EF3611SSB.....	160, 167	EF4802KP.....	160	EFL2430979S.....	156
EF2443CP.....	161	EF3611SSPT.....	160	EF4806KP.....	160	EFL3009656S.....	153

Model No.	Page	Model No.	Page	Model No.	Page	Model No.	Page
EFL3009767S.....	154	EFL4212433S.....	152	EFO2412868A.....	155	EFO3615656A.....	153
EFL3009868S.....	155	EFL4212656S.....	153	EFO2412979A.....	156	EFO3615767A.....	154
EFL3009979S.....	156	EFL4212767S.....	154	EFO2415433A.....	152	EFO3615868A.....	155
EFL3012433S.....	152	EFL4212868S.....	155	EFO2415656A.....	153	EFO3615979A.....	156
EFL3012656S.....	153	EFL4212979S.....	156	EFO2415767A.....	154	EFO3618433A.....	152
EFL3012767S.....	154	EFL4215433S.....	152	EFO2415868A.....	155	EFO3618656A.....	153
EFL3012868S.....	155	EFL4215656S.....	153	EFO2415979A.....	156	EFO3618767A.....	154
EFL3012979S.....	156	EFL4215767S.....	154	EFO2418433A.....	152	EFO3618868A.....	155
EFL3015433S.....	152	EFL4215868S.....	155	EFO2418656A.....	153	EFO3618979A.....	156
EFL3015656S.....	153	EFL4215979S.....	156	EFO2418767A.....	154	EFO3624433A.....	152
EFL3015767S.....	154	EFL4218433S.....	152	EFO2418868A.....	155	EFO3624656A.....	153
EFL3015868S.....	155	EFL4218656S.....	153	EFO2418979A.....	156	EFO3624767A.....	154
EFL3015979S.....	156	EFL4218767S.....	154	EFO2424433A.....	152	EFO3624868A.....	155
EFL3018433S.....	152	EFL4218868S.....	155	EFO2424656A.....	153	EFO3624979A.....	156
EFL3018656S.....	153	EFL4218979S.....	156	EFO2424767A.....	154	EFO3630433A.....	152
EFL3018767S.....	154	EFL4224433S.....	152	EFO2424868A.....	155	EFO3630656A.....	153
EFL3018868S.....	155	EFL4224656S.....	153	EFO2424979A.....	156	EFO3630767A.....	154
EFL3018979S.....	156	EFL4224767S.....	154	EFO2430433A.....	152	EFO3630868A.....	155
EFL3024433S.....	152	EFL4224868S.....	155	EFO2430656A.....	153	EFO3630979A.....	156
EFL3024656S.....	153	EFL4224979S.....	156	EFO2430767A.....	154	EFO4209656A.....	153
EFL3024767S.....	154	EFL4230433S.....	152	EFO2430868A.....	155	EFO4209767A.....	154
EFL3024868S.....	155	EFL4230656S.....	153	EFO2430979A.....	156	EFO4209868A.....	155
EFL3024979S.....	156	EFL4230767S.....	154	EFO3009656A.....	153	EFO4209979A.....	156
EFL3030433S.....	152	EFL4230868S.....	155	EFO3009767A.....	154	EFO4212433A.....	152
EFL3030656S.....	153	EFL4230979S.....	156	EFO3009868A.....	155	EFO4212656A.....	153
EFL3030767S.....	154	EFL4809656S.....	153	EFO3009979A.....	156	EFO4212767A.....	154
EFL3030868S.....	155	EFL4809767S.....	154	EFO3012433A.....	152	EFO4212868A.....	155
EFL3030979S.....	156	EFL4809868S.....	155	EFO3012656A.....	153	EFO4212979A.....	156
EFL3609656S.....	153	EFL4809979S.....	156	EFO3012767A.....	154	EFO4215433A.....	152
EFL3609767S.....	154	EFL4812433S.....	152	EFO3012868A.....	155	EFO4215656A.....	153
EFL3609868S.....	155	EFL4812656S.....	153	EFO3012979A.....	156	EFO4215767A.....	154
EFL3609979S.....	156	EFL4812767S.....	154	EFO3015433A.....	152	EFO4215868A.....	155
EFL3612433S.....	152	EFL4812868S.....	155	EFO3015656A.....	153	EFO4215979A.....	156
EFL3612656S.....	153	EFL4812979S.....	156	EFO3015767A.....	154	EFO4218433A.....	152
EFL3612767S.....	154	EFL4815433S.....	152	EFO3015868A.....	155	EFO4218656A.....	153
EFL3612868S.....	155	EFL4815656S.....	153	EFO3015979A.....	156	EFO4218767A.....	154
EFL3612979S.....	156	EFL4815767S.....	154	EFO3018433A.....	152	EFO4218868A.....	155
EFL3615433S.....	152	EFL4815868S.....	155	EFO3018656A.....	153	EFO4218979A.....	156
EFL3615656S.....	153	EFL4815979S.....	156	EFO3018767A.....	154	EFO4224433A.....	152
EFL3615767S.....	154	EFL4818433S.....	152	EFO3018868A.....	155	EFO4224656A.....	153
EFL3615868S.....	155	EFL4818656S.....	153	EFO3018979A.....	156	EFO4224767A.....	154
EFL3615979S.....	156	EFL4818767S.....	154	EFO3024433A.....	152	EFO4224868A.....	155
EFL3618433S.....	152	EFL4818868S.....	155	EFO3024656A.....	153	EFO4224979A.....	156
EFL3618656S.....	153	EFL4818979S.....	156	EFO3024767A.....	154	EFO4230433A.....	152
EFL3618767S.....	154	EFL4824433S.....	152	EFO3024868A.....	155	EFO4230656A.....	153
EFL3618868S.....	155	EFL4824656S.....	153	EFO3024979A.....	156	EFO4230767A.....	154
EFL3618979S.....	156	EFL4824767S.....	154	EFO3030433A.....	152	EFO4230868A.....	155
EFL3624433S.....	152	EFL4824868S.....	155	EFO3030656A.....	153	EFO4230979A.....	156
EFL3624656S.....	153	EFL4824979S.....	156	EFO3030767A.....	154	EFO4809656A.....	153
EFL3624767S.....	154	EFL4830433S.....	152	EFO3030868A.....	155	EFO4809767A.....	154
EFL3624868S.....	151, 155	EFL4830656S.....	153	EFO3030979A.....	156	EFO4809868A.....	155
EFL3624979S.....	156	EFL4830767S.....	154	EFO3609656A.....	153	EFO4809979A.....	156
EFL3630433S.....	152	EFL4830868S.....	155	EFO3609767A.....	154	EFO4812433A.....	152
EFL3630656S.....	153	EFL4830979S.....	156	EFO3609868A.....	155	EFO4812656A.....	153
EFL3630767S.....	154	EFO2409656A.....	153	EFO3609979A.....	156	EFO4812767A.....	154
EFL3630868S.....	155	EFO2409767A.....	154	EFO3612433A.....	152	EFO4812868A.....	155
EFL3630979S.....	156	EFO2409868A.....	155	EFO3612656A.....	153	EFO4812979A.....	156
EFL4209656S.....	153	EFO2409979A.....	156	EFO3612767A.....	154	EFO4815433A.....	152
EFL4209767S.....	154	EFO2412433A.....	152	EFO3612868A.....	155	EFO4815656A.....	153
EFL4209868S.....	155	EFO2412656A.....	153	EFO3612979A.....	156	EFO4815767A.....	154
EFL4209979S.....	156	EFO2412767A.....	154	EFO3615433A.....	152	EFO4815868A.....	155

Office Suites  
Seating  
Tables & Desks  
Meeting Essentials  
Personal Organization  
Ergonomics  
High Density Storage  
Storage & Filing  
Facilities  
Technology Furniture  
Art & Engineering  
K-12 Education  
SAFE Collection Addendum

Model No.	Page	Model No.	Page	Model No.	Page	Model No.	Page
EFO4815979A.....	156	EFPL428211.....	164	EFT3030656A.....	153	EFT4230979A.....	156
EFO4818433A.....	152	EFPL428322.....	164	EFT3030767A.....	154	EFT4809656A.....	153
EFO4818656A.....	153	EFPL428433.....	164	EFT3030868A.....	155	EFT4809767A.....	154
EFO4818767A.....	154	EFSR367676A.....	162	EFT3030979A.....	156	EFT4809868A.....	155
EFO4818868A.....	155	EFSR367676S.....	162	EFT3609656A.....	153	EFT4809979A.....	156
EFO4818979A.....	156	EFSR3676410A.....	162	EFT3609767A.....	154	EFT4812433A.....	152
EFO4824433A.....	152	EFSR3676410S.....	162	EFT3609868A.....	155	EFT4812656A.....	153
EFO4824656A.....	153	EFT2409656A.....	153	EFT3609979A.....	156	EFT4812767A.....	154
EFO4824767A.....	154	EFT2409767A.....	154	EFT3612433A.....	152	EFT4812868A.....	155
EFO4824868A.....	155	EFT2409868A.....	155	EFT3612656A.....	153	EFT4812979A.....	156
EFO4824979A.....	156	EFT2409979A.....	156	EFT3612767A.....	154	EFT4815433A.....	152
EFO4830433A.....	152	EFT2412433A.....	152	EFT3612868A.....	155	EFT4815656A.....	153
EFO4830656A.....	153	EFT2412656A.....	153	EFT3612979A.....	156	EFT4815767A.....	154
EFO4830767A.....	154	EFT2412767A.....	154	EFT3615433A.....	152	EFT4815868A.....	155
EFO4830868A.....	155	EFT2412868A.....	155	EFT3615656A.....	153	EFT4815979A.....	156
EFO4830979A.....	156	EFT2412979A.....	156	EFT3615767A.....	154	EFT4818433A.....	152
EFPG36721.....	165	EFT2415433A.....	152	EFT3615868A.....	155	EFT4818656A.....	153
EFPG36732.....	165	EFT2415656A.....	153	EFT3615979A.....	156	EFT4818767A.....	154
EFPG36743.....	165	EFT2415767A.....	154	EFT3618433A.....	152	EFT4818868A.....	155
EFPG36821.....	165	EFT2415868A.....	155	EFT3618656A.....	153	EFT4818979A.....	156
EFPG36832.....	165	EFT2415979A.....	156	EFT3618767A.....	154	EFT4824433A.....	152
EFPG36843.....	165	EFT2418433A.....	152	EFT3618868A.....	155	EFT4824656A.....	153
EFPG42721.....	165	EFT2418656A.....	153	EFT3618979A.....	156	EFT4824767A.....	154
EFPG42732.....	165	EFT2418767A.....	154	EFT3624433A.....	152	EFT4824868A.....	155
EFPG42743.....	165	EFT2418868A.....	155	EFT3624656A.....	153	EFT4824979A.....	156
EFPG42821.....	165	EFT2418979A.....	156	EFT3624767A.....	154	EFT4830433A.....	152
EFPG42832.....	165	EFT2424433A.....	152	EFT3624868A.....	155	EFT4830656A.....	153
EFPG42843.....	165	EFT2424656A.....	153	EFT3624979A.....	156	EFT4830767A.....	154
EFPG367211.....	165	EFT2424767A.....	154	EFT3630433A.....	152	EFT4830868A.....	155
EFPG367322.....	165	EFT2424868A.....	155	EFT3630656A.....	153	EFT4830979A.....	156
EFPG367433.....	165	EFT2424979A.....	156	EFT3630767A.....	154	EML3652X.....	150
EFPG368211.....	165	EFT2430433A.....	152	EFT3630868A.....	155	EML3653X.....	150
EFPG368322.....	165	EFT2430656A.....	153	EFT3630979A.....	156	EML3654X.....	150
EFPG368433.....	165	EFT2430767A.....	154	EFT4209656A.....	153	EML3672G.....	150
EFPG427211.....	165	EFT2430868A.....	155	EFT4209767A.....	154	EML3672L.....	149
EFPG427322.....	165	EFT2430979A.....	156	EFT4209868A.....	155	EML3673G.....	150
EFPG427433.....	165	EFT3009656A.....	153	EFT4209979A.....	156	EML3673L.....	149
EFPG428211.....	165	EFT3009767A.....	154	EFT4212433A.....	152	EML3674G.....	150
EFPG428322.....	165	EFT3009868A.....	155	EFT4212656A.....	153	EML3674L.....	149
EFPG428433.....	165	EFT3009979A.....	156	EFT4212767A.....	154	EML4852X.....	150
EFPL36721.....	164	EFT3012433A.....	152	EFT4212868A.....	155	EML4853X.....	150
EFPL36732.....	164	EFT3012656A.....	153	EFT4212979A.....	156	EML4854X.....	150
EFPL36743.....	164	EFT3012767A.....	154	EFT4215433A.....	152	EML4872G.....	150
EFPL36821.....	164	EFT3012868A.....	155	EFT4215656A.....	153	EML4872L.....	149
EFPL36832.....	164	EFT3012979A.....	156	EFT4215767A.....	154	EML4873G.....	150
EFPL36843.....	164	EFT3015433A.....	152	EFT4215868A.....	155	EML4873L.....	149
EFPL42721.....	164	EFT3015656A.....	153	EFT4215979A.....	156	EML4874G.....	150
EFPL42732.....	164	EFT3015767A.....	154	EFT4218433A.....	152	EML4874L.....	149
EFPL42743.....	164	EFT3015868A.....	155	EFT4218656A.....	153	EML7272G.....	150
EFPL42821.....	164	EFT3015979A.....	156	EFT4218767A.....	154	EML7272L.....	149
EFPL42832.....	164	EFT3018433A.....	152	EFT4218868A.....	155	EML7273G.....	150
EFPL42843.....	164	EFT3018656A.....	153	EFT4218979A.....	156	EML7273L.....	149
EFPL367211.....	164	EFT3018767A.....	154	EFT4224433A.....	152	EML7274G.....	150
EFPL367322.....	164	EFT3018868A.....	155	EFT4224656A.....	153	EML7274L.....	149
EFPL367433.....	164	EFT3018979A.....	156	EFT4224767A.....	154	EML9672L.....	149
EFPL368211.....	164	EFT3024433A.....	152	EFT4224868A.....	155	EML9673L.....	149
EFPL368322.....	164	EFT3024656A.....	153	EFT4224979A.....	156	EML9674L.....	149
EFPL368433.....	164	EFT3024767A.....	154	EFT4230433A.....	152	ESC2.....	78
EFPL427211.....	164	EFT3024868A.....	155	EFT4230656A.....	153	ESS2.....	78
EFPL427322.....	164	EFT3024979A.....	156	EFT4230767A.....	154	EX30SS.....	167
EFPL427433.....	164	EFT3030433A.....	152	EFT4230868A.....	155	EX36SS.....	167

Office Suites  
Seating  
Tables & Desks  
Meeting Essentials  
Personal Organization  
Ergonomics  
High Density Storage  
Storage & Filing  
Facilities  
Technology Furniture  
Art & Engineering  
Education  
SAFE Collection Addendum



Model No.	Page	Model No.	Page	Model No.	Page	Model No.	Page
EX425S	167	FF5322	177	JN7218	89	ML222460	104
EX485S	167	FF6322	177	JN7224	89	ML2223060	104
EX3018S	167	FF7211	177	JN7230	89	ML322460	104
EX3036S	167	FF7322	177	JN7236	90	ML323060	104
EX3618S	167	FFD	177	JN8442	90	MNBBF	21
EX3636S	167	FFD5	177	JN9642	90	MNBDG	20
EX4218S	167	FFD6	177	JN9642	90	MNBDGH3	20
EX4236S	167	FFD7	177	JN9642	90	MNBDGL	19
EX4818S	167	FFDMK	177	KB3312D	178	MNBDGR	19
EX4836S	167	FH3621	172	KB3312E	178	MNC8	22
EXL2418865S	166	FH3632	172	KSX1	66, 75	MNC10	22
EXL2436865S	166	FH3643	172	KTS1	66	MNC12	22
EXL3018865S	166	FH4232	172	KTS2	66	MNC14	22
EXL3036865S	166	FH36322	172	KTS3	66	MNCNZ72	19
EXL3618865S	166	FH36433	172	KTX1	66	MNCR48	22
EXL3636865S	166	FH48433	172	KTX2	66	MND72	19
EXL4218865S	166	FPALOCK	162	KTX3	66	MNDS63	20
EXL4236865S	166	FPALOCKA	162	LATH36521	179	MNDS72	20
EXL4818865S	166	FPALOCKB	162	LATH36532	179	MNDSHA72	23
EXL4836865S	166	FPALOCKC	162	LATH36543	179	MNEXTL	19
EXT2418865A	166	FPALOCKD	162	LATH42521	179	MNEXTR	19
EXT2436865A	166	GLCHAIR4	66-67	LATH42532	179	MNFF	21
EXT3018865A	166	GMT1	50	LATH42543	179	MNH63	20
EXT3036865A	166	GMT2	50	LATH365211	179	MNH72	20
EXT3618865A	166	HACK	123	LATH365322	179	MNPB	22
EXT3636865A	166	HADC	123	LATH365433	179	MNPO	20
EXT4218865A	166	HADJ18303GR	98, 260	LATH425211	179	MNRBBF	22
EXT4236865A	166	HADJ18304GR	98, 260	LATH425322	179	MNRFF	22
EXT4818865A	166	HADJ29443GR	98, 260	LATH425433	179	MNRS	22
EXT4836865A	166	HADJ29444GR	98, 260	LC24	92	MNRSBF	22
EZDP	12, 143	HLT302	43, 179	LF1848	92	MNRSLBF	22
EZKC1	143	HLT303	43, 179	LF1848T	92	MNRT	20
EZKC2	143	HLT304	43, 179	LF1860	92	MNRTPL	19
EZSCK	50	HLT305	43, 179	LF1860T	92	MNRTPR	19
F09DV6	160	HLT362	43, 179	LF1872	92	MNT51H	23
F09DV24	160	HLT363	43, 179	LF2448	92	MOS36	171
F12DV6	160, 175	HLT364	43, 179	LF2448T	92	MOS42	171
F12DV24	160	HLT365	43, 179	LF2448TSFLK4	92	MOS48	171
F15DV6	160, 175	HLT422	43, 179	LF2460	92	MR42R	27
F15DV24	160	HLT423	43, 179	LF2460T	92	MRB53	26
F15SRA	160	HLT424	43, 179	LF2472	92	MRB55	26
F18SRA	160, 167	HLT425	43, 179	LF2472T	92	MRCBF7220	25
F24SRA	160	HLTDV10	43, 179	LP24	92	MRCFT	27
F30SRA	160	HLTFBR4	43, 179	LT24	92	MRCH8	27
F36SRA	160, 167	HMKEY	43, 179	MC363030DH	229	MRC58	27
F740	41, 50, 111	JN36RD	90	MC363030H	229	MRD362	170
F740POWB	91, 110	JN36SQ	90	MC483030DH	229	MRD422	170
F740POWW	91, 110	JN42RD	90	MC483030H	229	MRD482	170
F740USBB	91, 110	JN42SQ	90	MC603030DH	229	MRDBF7236	25
F740USBCB	91	JN4818	89	MC603030H	229	MRET	27
F740USBCW	91	JN4824	89	MC723030DH	229	MRF362	170
F740USBW	91, 110	JN4830	89	MC723030H	229	MRF422	170
F890	111	JN5418	89	MCM	170	MRF482	170
FF521	177	JN5424	89	MCM361	170	MRGDC	26
FF532	177	JN5430	89	MCM421	170	MRH12	27
FF543	177	JN6018	89	MCM481	170	MRH16	27
FF621	177	JN6024	89	MDV	170	MRHG72	26
FF632	177	JN6030	89	MFD4	169	MRHTGD72	26
FF721	177	JN6618	89	MFD36	169	MRHTWD72	26
FF732	177	JN6624	89	MFD42	169	MRHW72	26
FF743	177	JN6630	89	MFD48	169	MRLF36	26

Office Suites  
Seating  
Tables & Desks  
Meeting Essentials  
Personal Organization  
Ergonomics  
High Density Storage  
Storage & Filing  
Facilities  
Technology Furniture  
Art & Engineering  
K-12 Education  
SAFE Collection Addendum

Model No.	Page	Model No.	Page	Model No.	Page	Model No.	Page
MRLSBF7236	25	R104R	108	RESDRKTWH	119	SPK60	99
MRLWCGD	26	R104V	108	RESENTNA	81	SPK72	99
MRLWCWD	26	R124B	108	REGDRKTWH	119	SPK6020	99
MRP362	170	R124R	108	RESH72WH	119	SPK6024	99
MRP422	170	R124V	108	RESHDRKTWH	119	SPK7220	99
MRP482	170	R125B	108	RESHGDRKTWH	119	SPK7224	99
MRPM	25	R125R	108	RESORGWH	49	SPM	17, 108
MRPM3BLK	27	RBA4824FL	96	RESPEDWH	119	SR2446R	232
MRRD78	27	RBA6024	97	RESSHELFWH	49	SR4833	232
MRS12	27	RBA6024FL	96	RESUPDCL	119	SR4833R	232
MRS16	27	RBA6024PCA	97	RESUPINP	119	SR4846R	232
MRS36	169	RBA6024PG	97	RESUPDCWH	119	SR6033	232
MRS42	169	RBA6024TCA	97	RESUPUWH	119	SR6033R	232
MRS48	169	RBA6024TG	97	RESWRDWH	119	SR6046R	232
MRSCT36	26	RBA6030FL	96	SA3680G1	224	SRT4280A	233
MRWDC	26	RBA7224	97	SA3680L1	224	SRT4280B	233
MS3601	169	RBA7224FL	96	SC6	109	SRT4280C	233
MS3602	169	RBA7224PCA	97	SC8	109	SS12LC	171
MS3603	169	RBA7224PG	97	SC10	109	SS24GM0	226
MS4201	169	RBA7224TCA	97	SC12	109	SS24GM01	173
MS4202	169	RBA7224TG	97	SC2424	212	SS24LM0	226
MS4203	169	RBA7230FL	96	SC2433	212, 215	SS24LM01	173
MS4801	169	RBAFL4824	96	SC2441	212, 215	SS24N0	226
MS4802	169	RBAFL6024	96	SC2448	212, 215	SS33GM0	226
MS4803	169	RBAFL6024SL	96	SC3624	213	SS33GM01	173
MSC	21	RBAFL6030	96	SC3633	213, 216	SS33LM0	226
MTD72	20	RBAFL7224	96	SC3641	213, 216	SS33LM01	173
MVB5	21	RBAFL7230	96	SC3648	213, 216	SS33N0	226
MVBQ2	21	RBAFXPCA	97	SC4824	213	SS41GM0	226
MVLC	21	RBAFXPGL	97	SC4833	213, 216	SS41GM01	173
MVLF	21	RBAFXTCA	97	SC4841	213, 216	SS41LM0	226
NC6	109	RBAFXTGL	97	SC4848	213, 217	SS41LM01	173
NC8	109	RBAREC4824	96	SC6024	214	SS41N0	226
NC10	109	RBAREC6024	96	SC6033	214, 217	SS48GM0	226
NC12	109	RBAREC6024FNGYWI	96	SC6041	214, 217	SS48GM01	173
NC14	109	RBAREC6030	96	SC6048	214, 217	SS48LM0	226
NCR48	109	RBAREC7224	96	SC7224	214	SS48LM01	173
P3018	92, 94	RBAREC7230	96	SC7233	214, 218	SS48N0	226
P3024	92, 94	REALCC	15, 22, 31, 249	SC7241	214, 218	SS65GS101	173
P3030	94	REALCMK	15, 22, 31, 249	SC7248	214, 218	SS65LS101	173
P6018	92, 94	REALCRK	15, 22, 31, 249	SCC	68	SS80GS101	173
P6024	92, 94	REALS010	50	SCC4	68	SS80LS101	173
P6030	94	REALS011	50	SCR48	109	STC8	31
P9018	92, 94	REALS099	50	SCWB	109	STC10	31
P9024	92, 94	REALS100	50	SF3665B	224	STC12	31
P9030	94	REALS191	50	SF3665D	224	STC14	31
PM20	50, 111	REALS285	50	SF3680B	224	STC16	31
PM33	22, 27, 50, 111	REC4824	98, 260	SF3680D	224	STC72B	29
PMR22	50	REC6024	98, 260	SLF48	232	STEB	29
Q618	43	REC6030	98, 260	SLF60	232	STEC72B	29
R73B	108	REC6036	98, 260	SN4833	219, 221	STEC72F	29
R73R	108	REC7230	98, 260	SN4841	219, 221	STED72B	29
R73V	108	REC7236	98, 260	SN4848	219, 221	STEDPH72	30
R84B	108	RES2BEN3060WHNA	49	SN6033	220, 222	STEH72	30
R84R	108	RES4BEN3060WHNA	49	SN6041	220, 222	STELF	31
R84V	108	RES6BEN3060WHNA	49	SN6048	220, 222	STERL48B	30
R94B	108	RES42DUALPWH	49	SN7233	220, 222	STERR48B	30
R94R	108	RES42SINGPWH	49	SN7233C	219	STESPH72	30
R94V	108	RES2042PPSL	49	SN7241	220, 222	STLC72	29
R95V	108	RESCAB36WH	119	SN7248	220, 223	STRC72	31
R104B	108	RESDES3060WH	119	SN7248CH	221	STRD72B	29

Office Suites  
Seating  
Tables & Desks  
Meeting Essentials  
Personal Organization  
Ergonomics  
High Density Storage  
Storage & Filing  
Facilities  
Technology Furniture  
Art & Engineering  
Education  
K-12  
SAFE Collection Addendum



SAFE Collection Addendum K-12 Education Art & Engineering Technology Furniture Facilities Storage & Filing High Density Storage Ergonomics Personal Organization Meeting Essentials Tables & Desks Seating Office Suites

Model No.	Page	Model No.	Page	Model No.	Page	Model No.	Page
STSCB3	30	URS7	176				
SY1848	94	URS8	176				
SY1854	94	VCC1	82				
SY1860	94	VCC2	82				
SY1866	94	VCC3	82				
SY1872	94	VCCM	82				
SY2448	94	VCCMT	82				
SY2454	94	VCCS	82				
SY2460	94	WAV6030	98, 260				
SY2466	94	X18DV5	167				
SY2472	94	X18SR	167				
SY3048	94	X36SR	167				
SY3054	94	X1886L	166				
SY3060	94	YNG6030	98, 260				
SY3066	94						
SY3072	94						
SYC24	94						
SYP24	94						
SYT24	94						
SYT30	94						
TADEXT	91						
TADUSBUSBCB	91						
TADUSBUSBCW	91						
TAEUSBUSBCB	91						
TAEUSBUSBCW	91						
TAGC	90						
TAPDCI	91						
TAPUSBUSBCB	91						
TAPUSBUSBCW	91						
TB30	232						
TB48	232						
TB60	232						
TCNRLAM	229						
THEISIS	66						
TP48LAM	229						
TP60LAM	229						
TP72LAM	229						
TSA3630DH	228						
TSA3630H	228						
TSA4830DH	228						
TSA4830H	228						
TSA6030DH	228						
TSA6030H	228						
TSA7230DH	228						
TSA7230H	228						
TSH1	67						
TSH1F	67						
TSH2	67						
TSH2F	67						
TSH3	68						
TSH3F	68						
TSK3630	230						
TSK4830	230						
TSK6030	230						
TSK7230	230						
TSM2	68						
TW30LAM	229						
TW36LAM	229						
TW48LAM	229						
TW72LAM	229						
URS6	176						



**Safco®**  
AN LDI COMPANY

9300 West Research Center Road, Minneapolis, MN 55428  
Customer Service Phone 888-971-6225 Fax 763-971-1525  
Locations in Minneapolis, MN/Headquarters,  
Atlanta, GA, Riverside, CA, Milford, IA and Norfolk, VA  
©2023 Safco Products Company. All Rights Reserved.

**SAFCOPRODUCTS.COM**

**Safco® Products marketing materials are designed to be used as sales tools for our Dealer network.**

LPC\_JULY2022\_011923