

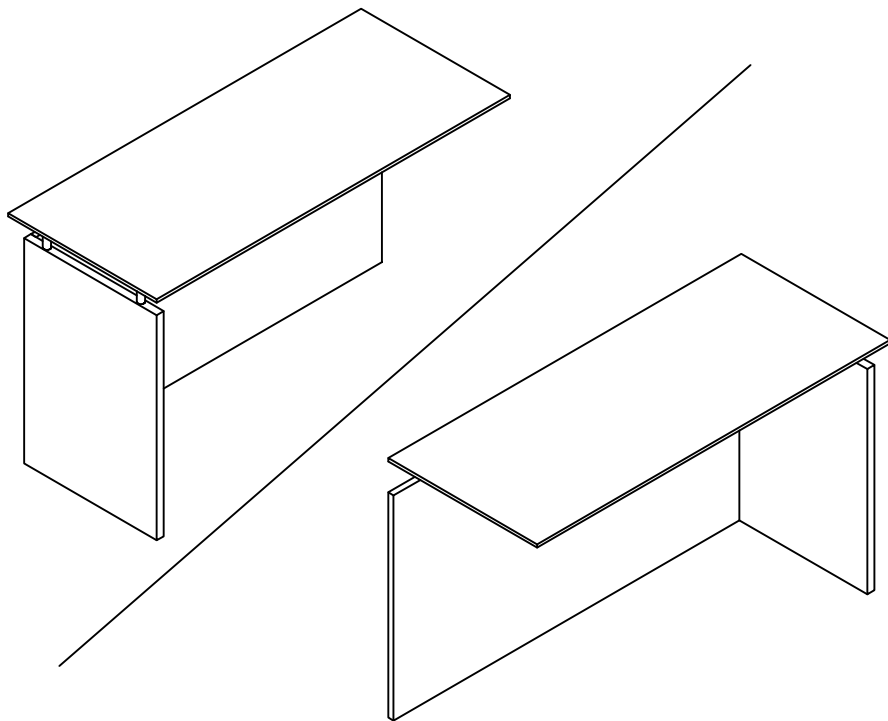





Medina Series TM
 48" Universal Straight Return
 Model No. MNRT

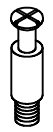
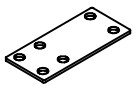

ASSEMBLY INSTRUCTIONS
 CALL 1-800-822-8037 FOR ASSISTANCE

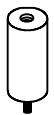
PARTS LIST

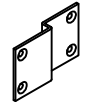
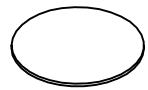
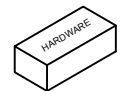
Name	Part	Qty.	Spare Qty	Name	Part	Qty.	Spare Qty
A	 REALS003 Cam Post	8	1	E	 REALS406 Mntg Plate	2	
B	 REALS001 Cam Lock	8	1	F	 REALS414 Base Stand-Off	4	
C	 REALS005 4 x 16mm	20	1	G	 REALS163 Z Bracket (65x 50 x 2mm)	2	
D	 REALS102** Cam Sticker	8	1		 MNCNZHB		

Items with HB are in hardware box.

**Denotes Color Code

PARTS LIST

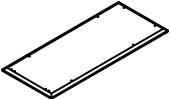
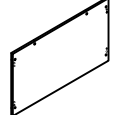
Name	Part	Qty.
H	 MNRT** Top	1
I	 MNRTI** Modesty Panel	1

Name	Part	Qty.
J	 MNRTJ** Side Panel	1

Pre-Assembled Replacement Part List

Replacement #	Part	Qty.
REALS425	 Leveler	2

**Denotes Color Code

2

IMPORTANT!

Review ALL instructions before beginning assembly. These instructions are provided to avoid problems that may occur from improper assembly or installation. Mayline and/or its distributor are not responsible for failure resulting from improper assembly or installation of this product. Moreover, all warranties are void for failure to follow these assembly instructions.

- 1 Insert Cams (B) into the Modesty Panel (I). Install Cam Posts (A) into threaded inserts in Side Panel (J). Attach Modesty Panel (I) to Side Panel (J) by turning Cams (B). Apply Cam Stickers (D) to Cams (B) of Modesty Panel (I).

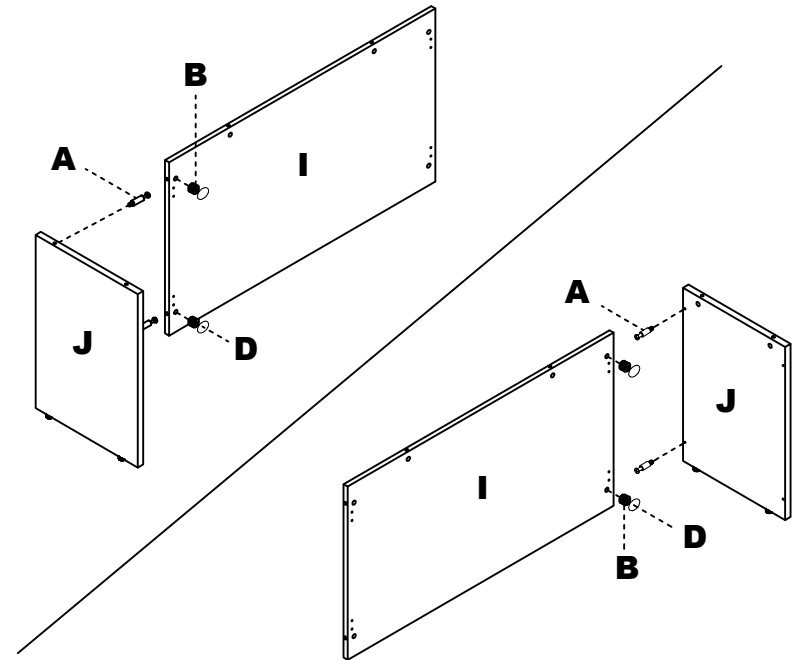

3

- 2** Install Base Stand-off (F) into threaded inserts in underside of Top (H). Attach Mntg Plates (E) to the underside of adjacent Top (H) using Screws (C).

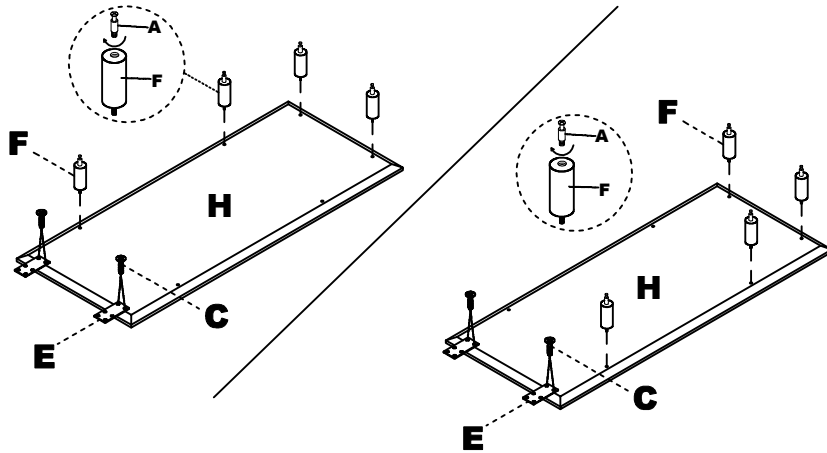

- 3** Insert Cams (B) into the Modesty Panel (I) and Side Panel (J). Place Top (H) onto Modesty Panel (I) and Side Panel (J) and lock in place by turning Cams (B). Apply Cam Stickers (D) to Cams (B) of Modesty Panel (I) and Side Panel (J).

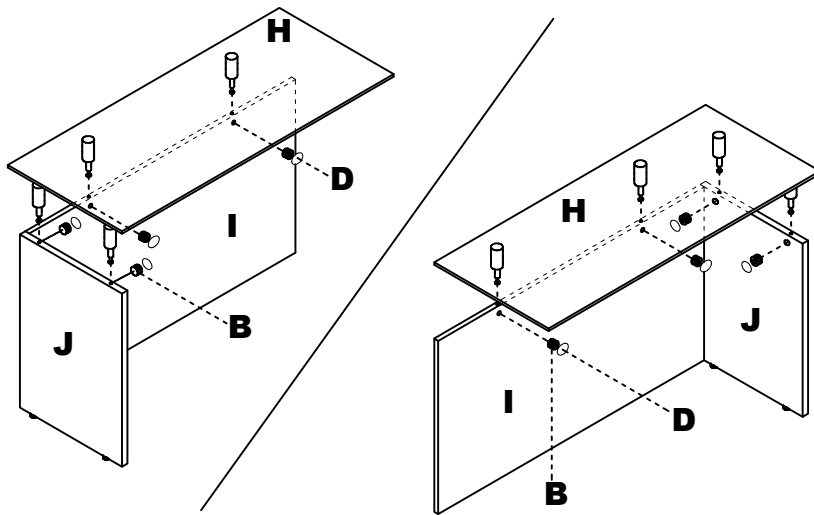

4

- 4** Attach MNRT to the Straight Main Desk using Screws (C). Attach Z Brackets (G) to Modesty Panel (I) using Screws (C).

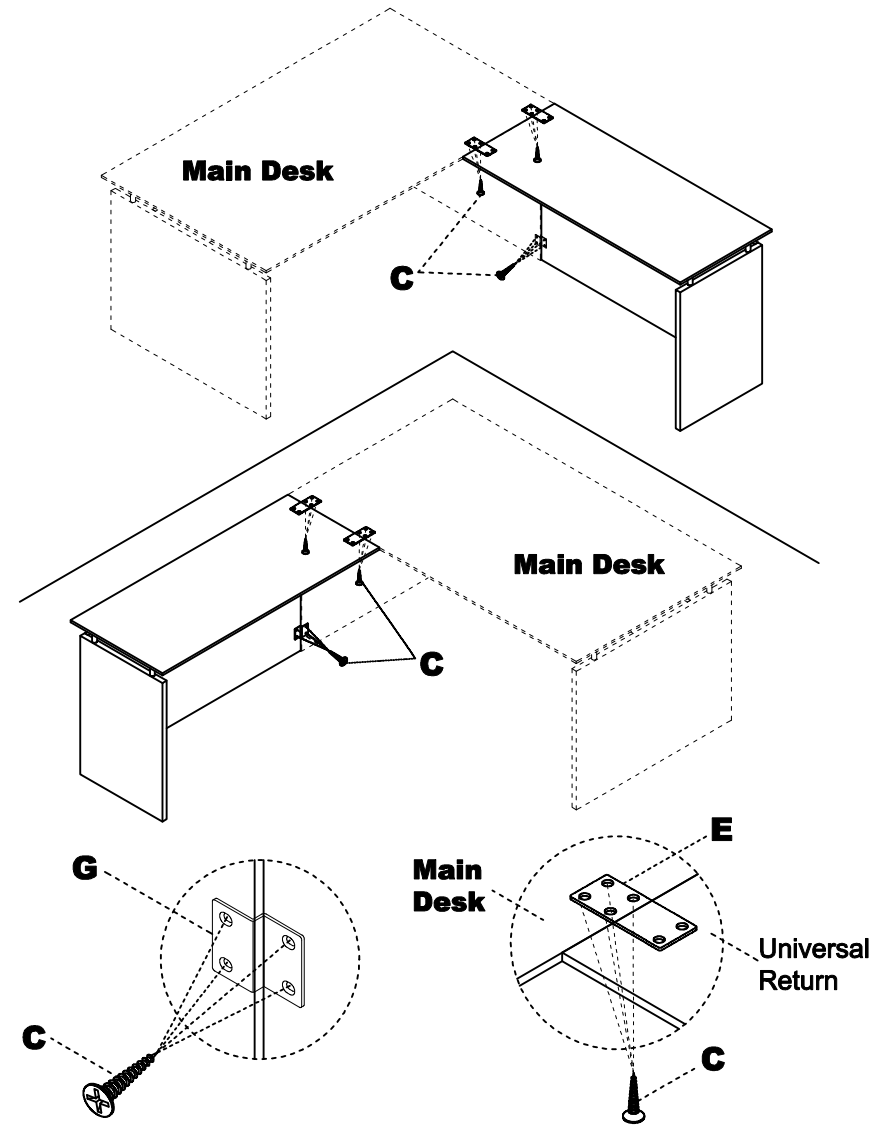

5