

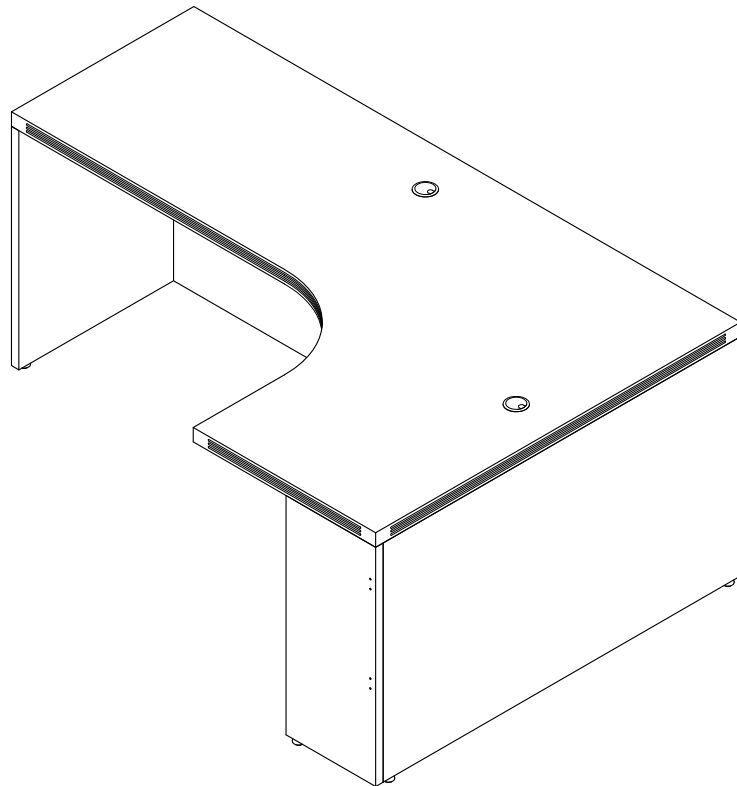

Aberdeen Series™
 Extended Corner, Right
 Model No. AEC72R

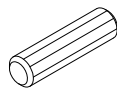

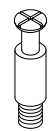
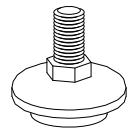
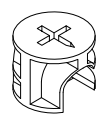
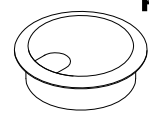
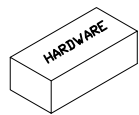

ASSEMBLY INSTRUCTIONS
CALL 1-800-822-8037 FOR ASSISTANCE

PARTS LIST

Name	Part	Qty.	Spare Qty	Name	Part	Qty.	Spare Qty
A	 REALS004 Wood Dowel	13	1	D	 REALS102** Cam Sticker	16	1
B	 REALS003 Cam Post	16	1	E	 REALS067 Leveler	5	
C	 REALS001 Cam Fastener	16	1	F	 REAL100 Grommet	2	
	 AECHB						

Items with HB are in hardware box.
 **Denotes Color Code

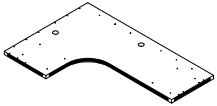
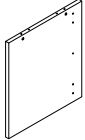
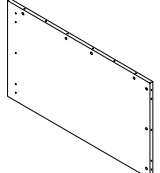
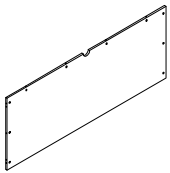
PARTS LIST

Name	Part	Qty.	Name	Part	Qty.
G	 AECRG** Top	1	J	 AECRJ** End Panel	1
H	 AECRH** Return Side Panel	1	K	 AECK** Modesty Panel	1
			L	 AECRL** Small End Panel	1

**Denotes Color Code

2

- 1** Insert Wood Dowels (A) into Modesty Panel (K), the Return Side Panel (H), the top of End Panel (J) and the top of the Small End Panel (L). Insert Cams (C) into Modesty Panel (K), Return Side Panel (H), End Panel (J) and Small End Panel (L). Install Cam Posts (B) into threaded inserts in the End panel (J), Return Side Panel (H), and Small End Panel (L). Screw Levelers (E) into bottom of Return Side panel (H), End Panel (J) and Small End Panel (L). Fasten panels together by turning Cams (C).

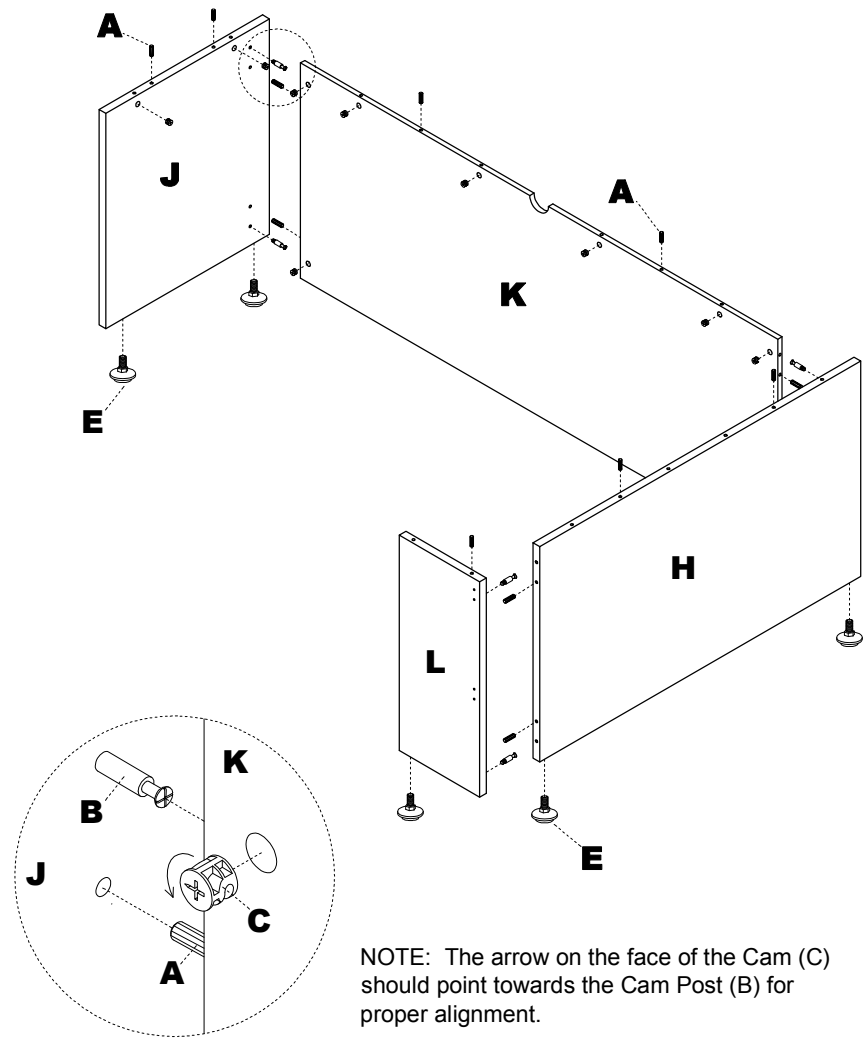

3

2 Install Cam Posts (B) into threaded inserts in Top (G).

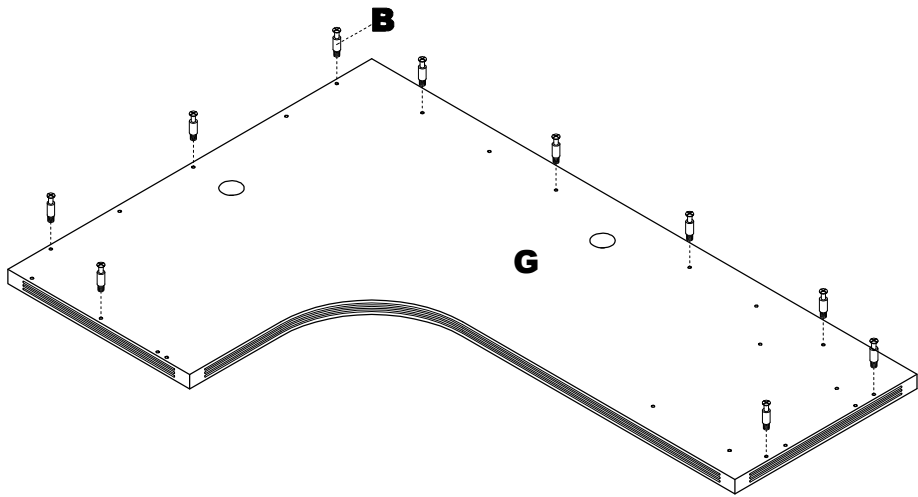

4

3 Place top onto base and lock in place by turning Cams (C). Apply Cam Stickers (D) onto Cams (C) and insert Grommets (F) into Top (G).

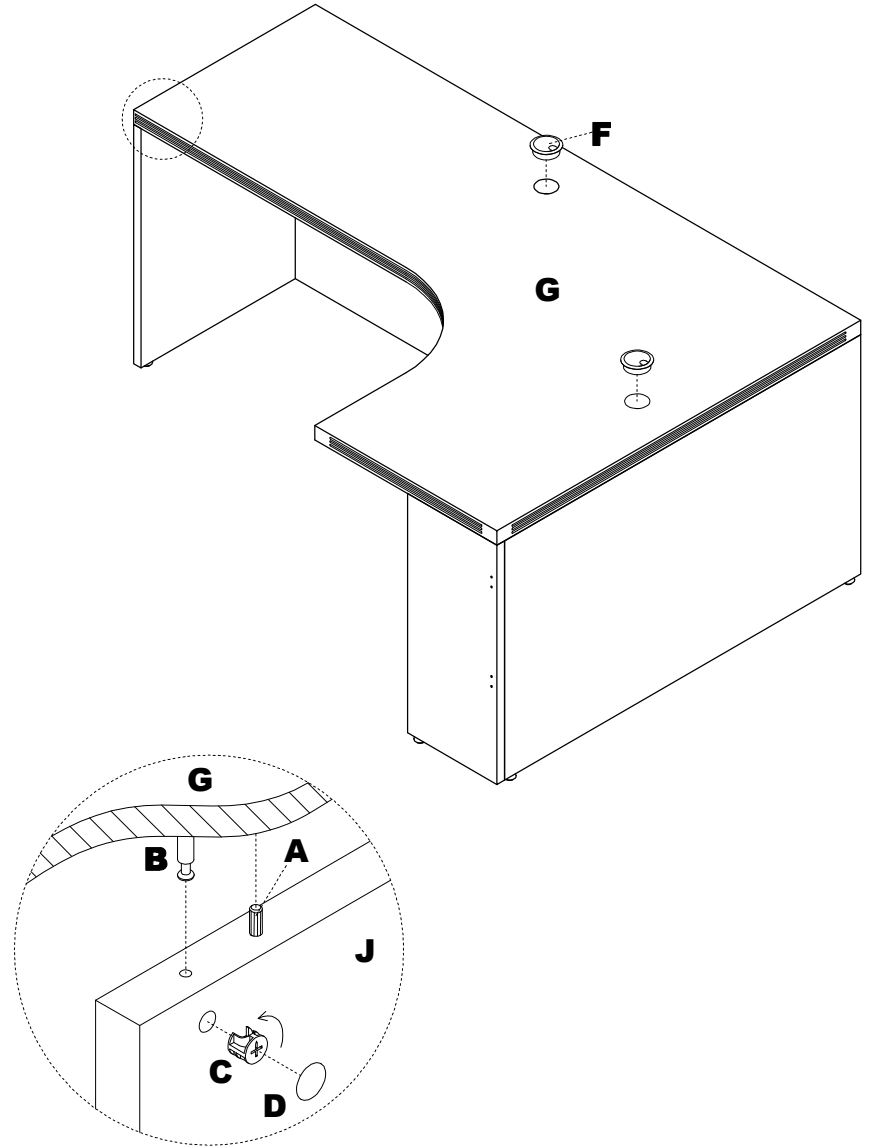

5