

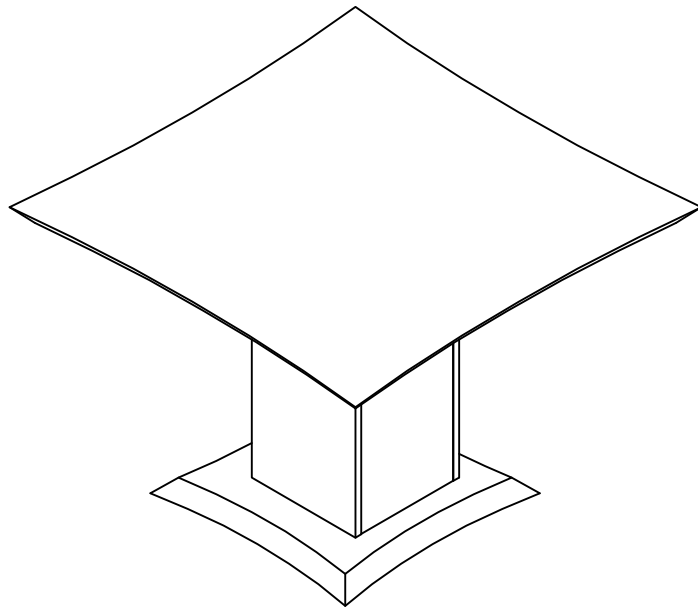



Sterling Series™
42" Conference Top
Model No. STECT42



ASSEMBLY INSTRUCTIONS

CALL 1-800-822-8037 FOR ASSISTANCE

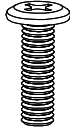
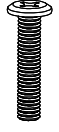
PARTS LIST

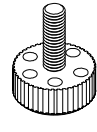
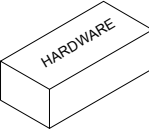
Name	Part	Qty.	Spare Qty	Name	Part	Qty.	Spare Qty
A	 REALS625 M6 x 35mm-Black <small>HB</small>	4	1	C	 REALS615 M8 x 55mm <small>HB</small>	4	1
B	 REALS614 M8 x 35mm <small>HB</small>	4	1	D	 REALS425 Leveler <small>HB</small>	4	
					 STECT42HB		

NOTE:

- ①. Top with Hardware packed in one carton - STECT42
- ②. Conference Base packed in one carton - STECB42

Items with HB are in hardware box.

PARTS LIST

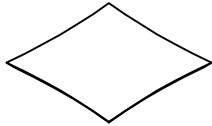
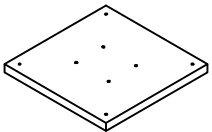
Name	Part	Qty.
E	 STECT42** Top	1
F	 STECT42F** Support Panel	1

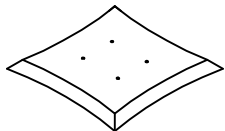
Name	Part	Qty.
G	 STECT42G** Bottom Panel	1

IMPORTANT!

Review ALL instructions before beginning assembly. These instructions are provided to avoid problems that may occur from improper assembly or installation. Mayline and/or its distributor are not responsible for failure resulting from improper assembly or installation of this product. Moreover, all warranties are void for failure to follow these assembly instructions.

**Denotes Color Code

2

- 1 Install Support Panel (F) to the Upper side of STECB42 (H) using Screws (B). Install Bottom Panel (G) to the Underside of STECB42 (H) using Screws (C). Install Levelers (D) into threaded inserts in underside of Bottom Panel (G).

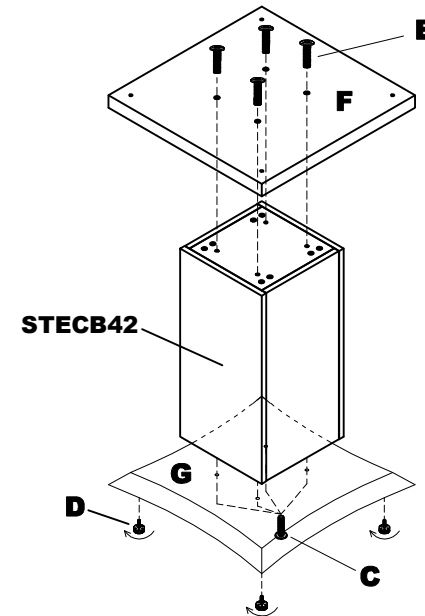

- 4 Install the Top (E) to Support Panel (F) using Screws (A).

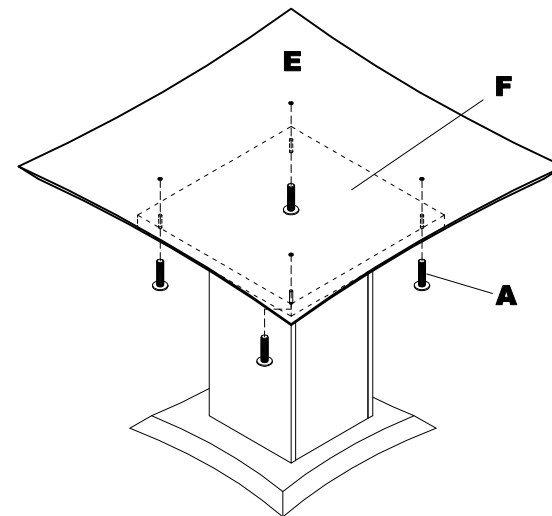

3