

**MAYLINE**

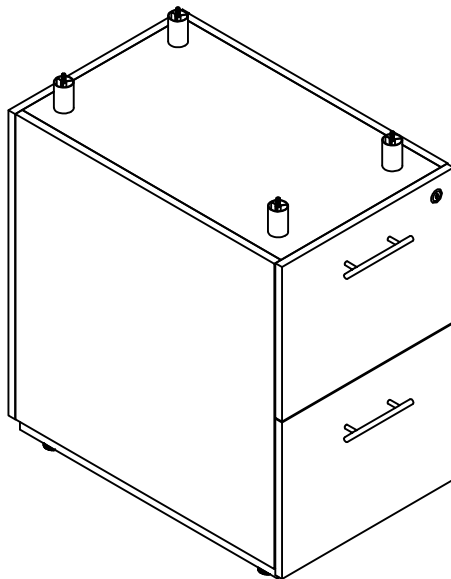





**Sterling Series™**  
**Desk Ped FF 26"**  
**Model No. STEDFF**

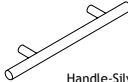

**ASSEMBLY INSTRUCTIONS**

**CALL 1-800-822-8037 FOR ASSISTANCE**

# PARTS LIST

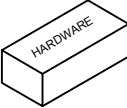
Name	Part	Qty.	Name	Part	Qty.
<b>A</b>	 Handle-Silver 96mm Center	<b>2</b>	<b>E</b>	 <b>REALS638</b> M6 Flange Nut	<b>5</b>
<b>B</b>	 Handle Screw M4x35mm White	<b>5</b>	<b>F</b>	 <b>REALS639</b> 10mm Wrench	<b>1</b>
<b>C</b>	 <b>REALS607</b> Ø32*50mm Base Stand-off	<b>4</b>	<b>G</b>	 Keys	<b>1</b>
<b>D</b>	 <b>REALS637</b> M6 x 35mm	<b>5</b>		 <b>STEDFFHB</b>	

Items with HB are in hardware box.

## IMPORTANT!

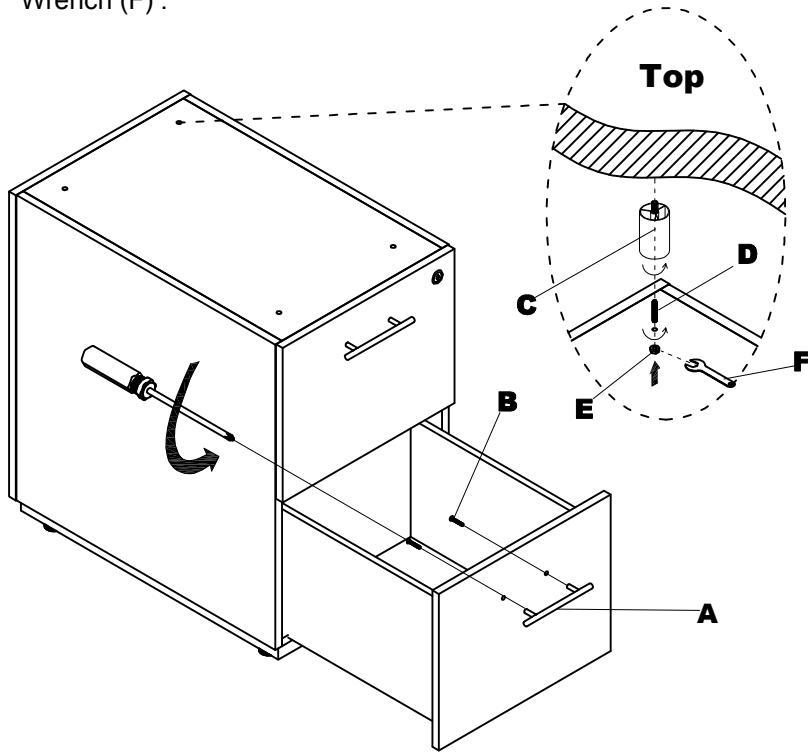

**Review ALL instructions before beginning assembly.** These instructions are provided to avoid problems that may occur from improper assembly or installation. Mayline and/or its distributor are not responsible for failure resulting from improper assembly or installation of this product. Moreover, all warranties are void for failure to follow these assembly instructions.

- 1** Attach Handles (A) to the Fronts of Drawer using Screws (B). Attach the Stand offs(C) to the Bottom of TOP using screws(E) and Wrench (F) .

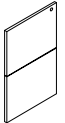

**2**

## Pre-Assembled Replacement Part List

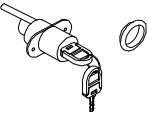
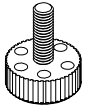
Part	Included Qty.	Part	Included Qty.
 STEDFFDF** Drawer Fronts, Set of 2	<b>1</b>	 <b>REALS616</b> 22" Extra Drawer Slides	<b>2</b>
 <b>REALS401</b> Lock w/ Key	<b>1</b>	 <b>REALS425</b> Leveler	<b>4</b>

\*\*Denotes Color Code

**3**