

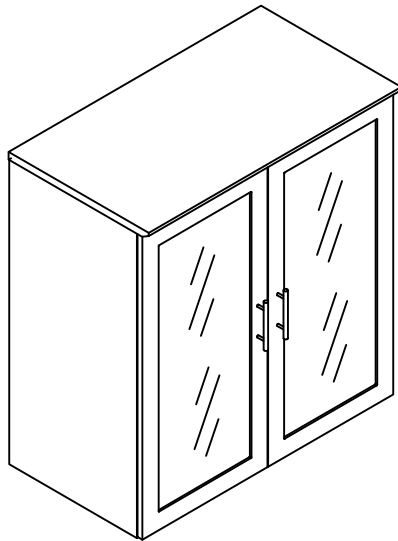









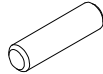
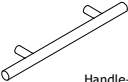

Medina Series™  
Glass Door Cabinet  
Model No. MGDC

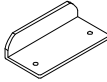

ASSEMBLY INSTRUCTIONS

CALL 1-800-822-8037 FOR ASSISTANCE







# PARTS LIST

Name	Part	Qty.	Spare Qty	Name	Part	Qty.	Spare Qty
<b>A</b>	 <b>REALS004</b> Wood Dowel	8	1	<b>G</b>	 Handle-Silver 96mm Center	2	
<b>B</b>	 <b>REALS001</b> Cam	8	1	<b>H</b>	 Handle Screw M4x35mm White	4	1
<b>C</b>	 <b>REALS002</b> Cam Post	8	1	<b>I</b>	 <b>REALS009</b> Shelf Support	8	1
<b>D</b>	 <b>REALS102**</b> Cam Sticker	8	1	<b>J</b>	 <b>REALS146</b> Ø3x19mm Black	20	1
<b>E</b>	 <b>REALS025</b> Door Stop	1		<b>K</b>	 <b>REALS428</b> Foam Tape 15mm	2	
<b>F</b>	 <b>REALS017</b> Ø3.5 x 16mm White	2	1		 <b>MGDCHB</b>		

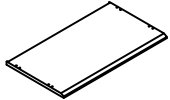
Items with HB are in hardware box.

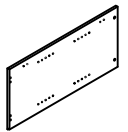
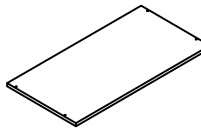
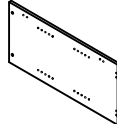
\*\*Denotes Color Code

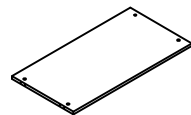
# PARTS LIST

Name	Part	Qty.	Name	Part	Qty.
L	 <b>MGDCL**</b> Top	1	P	 <b>MGDCP**</b> Back Panel	1
M	 <b>MGDCM**</b> Left Side Panel	1	Q	 <b>MGDCQ**</b> Shelf Panel	2
N	 <b>MGDCN**</b> Right Side Panel	1	R	 <b>MGDCR**</b> Right Door	1
O	 <b>MGDCO**</b> Bottom Panel	1	S	 <b>MGDCS**</b> Left Door	1

\*\*Denotes Color Code

2

## IMPORTANT!

**Review ALL instructions before beginning assembly.** These instructions are provided to avoid problems that may occur from improper assembly or installation. Mayline and/or its distributor are not responsible for failure resulting from improper assembly or installation of this product. Moreover, all warranties are void for failure to follow these assembly instructions.

- 1 Insert Wood Dowels (A) into Bottom Panel (O). Install Cam Posts (C) into Side Panels (M & N). Insert Cams (B) in the underside of the Bottom Panel (O). Attach Side Panels (M & N) and Bottom Panel (O) by turning Cams (B). Adhere Cam Stickers (D) to Cams (B). Adhere the Single side Tape (K) to the bottom of the Side Panels (M & N).

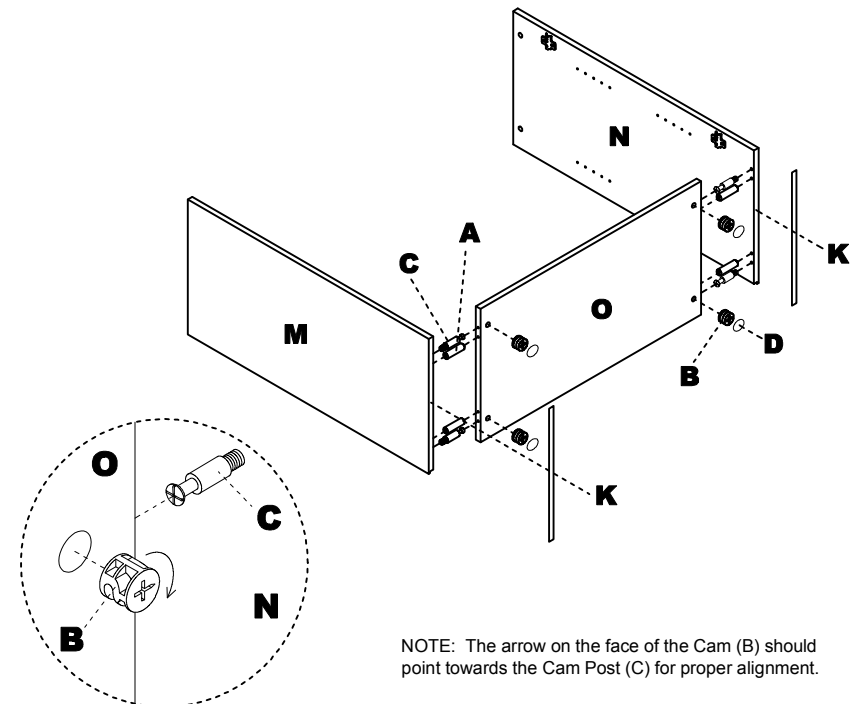

3

- 2** Insert Wood Dowels (A) into Side Panels (M & N). Insert Cam (B) into Side Panel (M & N). Install Cam Posts (C) to underside of Top (L). Attach Top (L) to assembled cabinet by turning Cams (B). Apply Cam Stickers (D) to Cams (B) of Side Panel (M & N). Attach Door Stop (E) to underside of Top (L) using Screws (F).

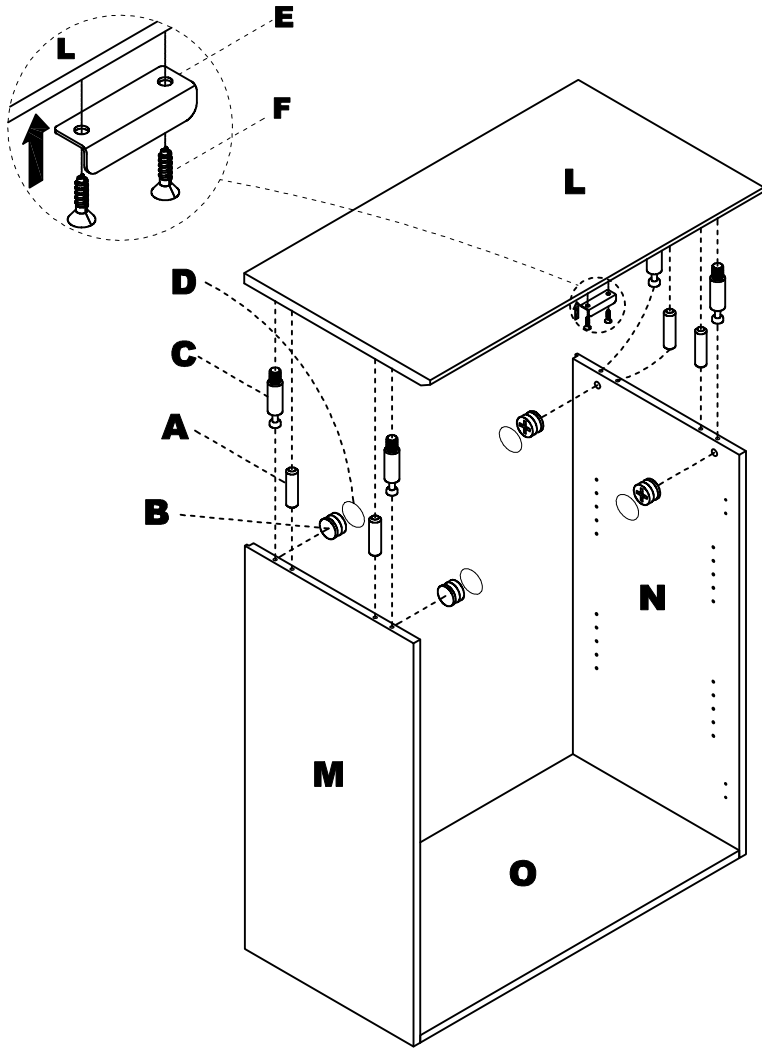

**4**

- 3** Attach the Back Panel (P) to the Top (L), Side Panels (M & N) and the Bottom Panel (O) by using Screws (J).

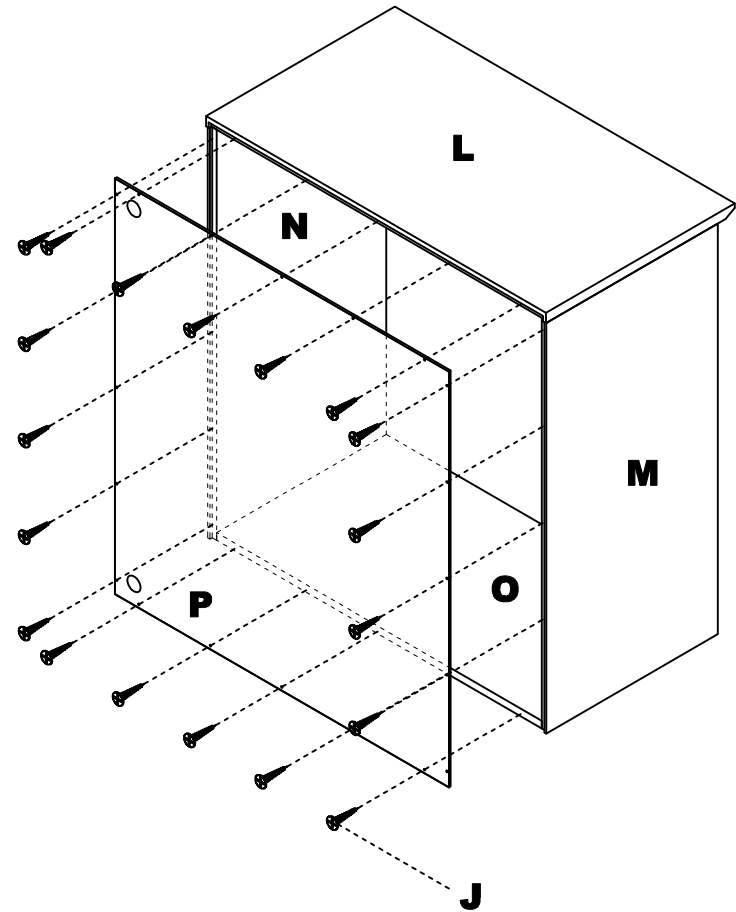

**5**

- 4** Insert Shelf Supports (K) into the Side Panels (P & Q) at the desired height. Put the Shelf Panel (S) on the Shelf Supports (K). Cover Levelers (E) access holes with Cam Caps (M) in Bottom Panel (T). Attach Handles (G) to Glass Doors (R & S) using Screws (H). Install Glass Doors (R & S) onto Cabinet. Adjust doors for alignment as necessary by using the adjustment screws on the hinges.

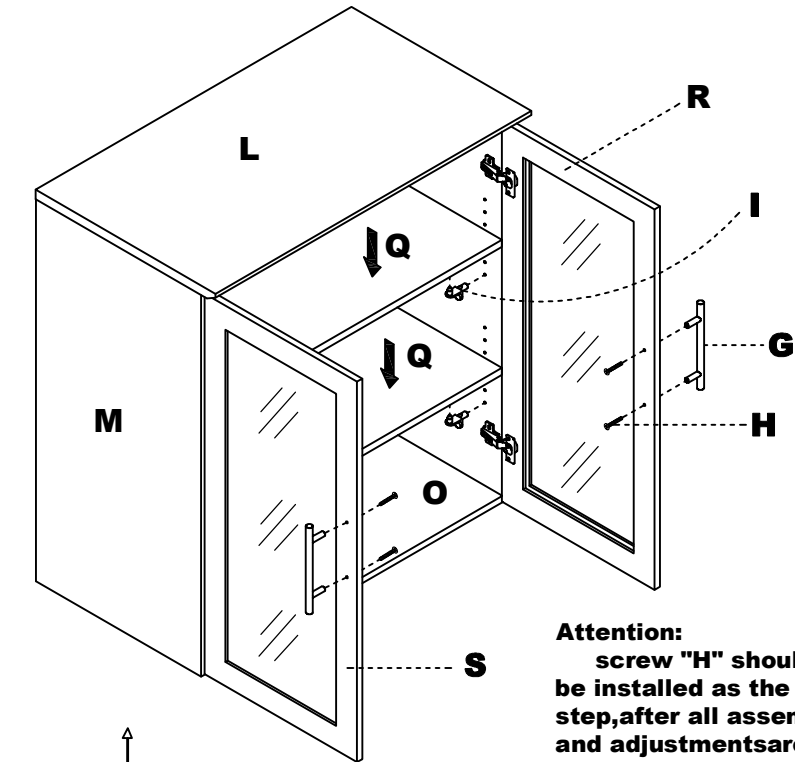

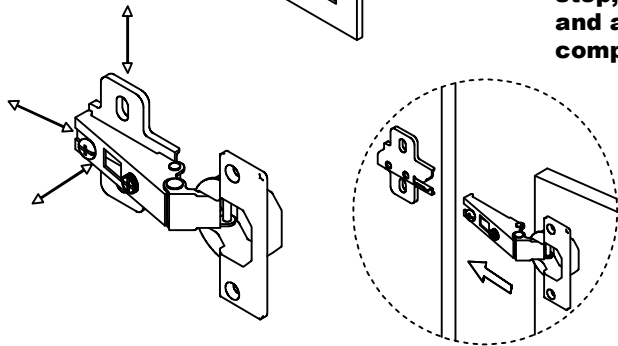

**Attention:**  
screw "H" should only  
be installed as the final  
step, after all assemblies  
and adjustments are  
complete

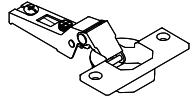

**6**

# Pre-Installed Replacement Parts List

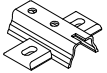
Part	Included Qty.	Part	Included Qty.
 <b>REALS418</b> Hinge-Overlay	<b>4</b>	 <b>REALS417</b> Ø4X14mm White	<b>16</b>
 <b>REALS418P</b> Hinge Plate-Overlay	<b>4</b>		

**7**