

ASSEMBLY INSTRUCTIONS
INSTRUCTIONS DE MONTAGE
INSTRUCCIONES DE ENSAMBLAJE

6268, 6269, 6270
Commercial Shelving
Étagères industrielle
Estantería industrial

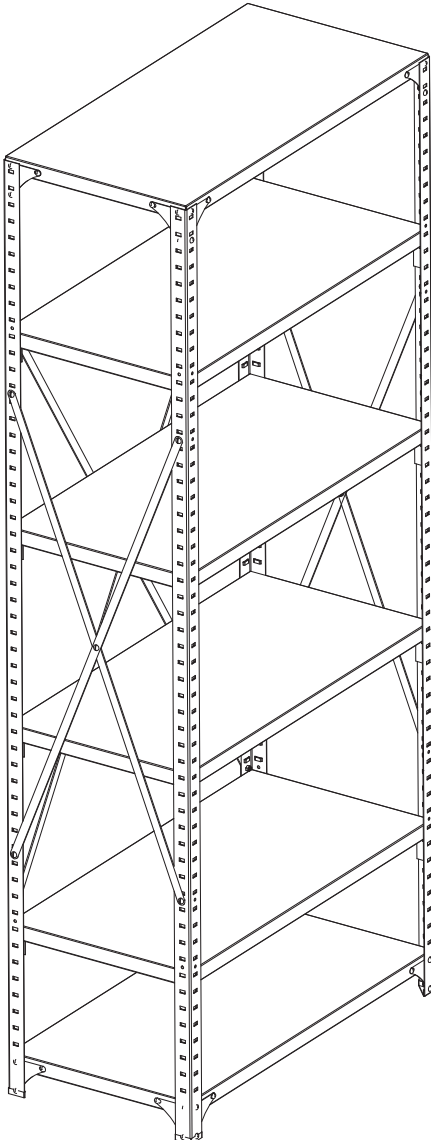

**Two people
recommended**
*Deux personnes ont
recommandé*
Dos personas
recomendadas

PRODUCT WARRANTY REGISTRATION is available online at: www.safcoproducts.com

• LA GARANTIE DU PRODUIT est
disponible sur l'Internet : www.safcoproducts.com

• LA GARANTÍA DEL PRODUCTO está
disponible en la Internet: www.safcoproducts.com

For questions or concerns, please call **1-800-664-0042**
available Monday-Friday 7:30 AM to 5:00 PM (Central Time) (English-speaking operators)

Si vous avez des questions pour poser ou les préoccupations
pour exprimer, connecter **au 1-800-664-0042**
de 7H30 à 17H00 (Heure centrale) (Opérateurs de langue anglaise)





Si usted tiene preguntas o preocupaciones,
por favor llame **1-800-664-0042**
de 7:30 AM a 5:00 PM (Hora Central) (Operadores que hablan inglés)

TOOLS REQUIRED: Screwdriver; Rubber Mallet

PARTS LIST

CODE	DESCRIPTION	QTY	PART NO.
(A)	Post 75" high	4	6265-03GR
(B)	Steel Shelf Top and Bottom 12" x 36" 18" x 36" 24" x 36"	2	6265-01GR\$ 6266-01GR\$ 6267-01GR\$
(C)	Steel Shelf center 12" x 36" 18" x 36" 24" x 36"	4	6265-02GR\$ 6266-02GR\$ 6267-02GR\$
(D)	Long Brace	2	6256-03GR
(E)	Short Brace	4	6256-02GR

HARDWARE PACK
6268-19NC

F 	G 	H 	I 	J 
Corner Clip Qty: 16 6250-26NC	Screw Qty: 63 6256-24NC	Nut Qty: 63 6256-25NC	Plastic Foot Qty: 4 6256-05NC	Corner Plate Qty: 16 6256-04GR

§ Note: When corresponding about the product don't forget to mention the shelf size.





To ensure that you have enough screws and nuts, extras have been included.

OUTILS REQUIS : Tournevis; Maillet du caoutchouc

LISTE DES PIÈCES

CODE	DESCRIPTION	QTY	PART NO.
(A)	Poste 75" de haut	4	6265-03GR
(B)	Étagère en acier haut et en bas 12" x 36" 18" x 36" 24" x 36"	2	6265-01GR\$ 6266-01GR\$ 6267-01GR\$
(C)	Étagère en acier Centre 12" x 36" 18" x 36" 24" x 36"	4	6265-02GR\$ 6266-02GR\$ 6267-02GR\$
(D)	longue étré sillon	2	6256-03GR
(E)	Court étré sillon	4	6256-02GR

PAQUET MATÉRIEL
6268-19NC

F 	G 	H 	I 	J 
Coin équerre Qté: 16 6250-26NC	Vis Qté: 63 6256-24NC	Écrou Qté: 63 6256-25NC	Plastique pied Qté: 4 6256-05NC	Coin plaque Qté: 16 6256-04GR

§ Note: Lorsque vous correspondez au sujet du produit, n'oubliez pas de mentionner la taille du Étagère.





Pour veiller à ce que vous avez suffisamment de vis et les écrous, les suppléments ont été inclus..

HERRAMIENTAS REQUERIDAS: Destornillador ;Mazo de caucho

LISTA DE PIEZAS

CODE	DESCRIPTION	QTY	PART NO.
(A)	Post 75" de alto	4	6265-03GR
(B)	Estante de acero parte superior e inferior 12" x 36" 18" x 36" 24" x 36"	2	6265-01GR\$ 6266-01GR\$ 6267-01GR\$
(C)	Estante de acero Centro 12" x 36" 18" x 36" 24" x 36"	4	6265-02GR\$ 6266-02GR\$ 6267-02GR\$
(D)	Puntal largo	2	6256-03GR
(E)	Corto puntal	4	6256-02GR

PAQUETE MATERIAL
6268-19NC

F 	G 	H 	I 	J 
Soporte de esquina Cant: 16 6250-26NC	Tornillo Cant: 63 6250-26NC	Tuerca Cant: 63 6256-25NC	Pie de plástico Cant: 4 6256-05NC	Esquina placa Cant: 16 6256-04GR

§ Nota: Cuando correspondientes sobre el producto no se olvide de mencionar el tamaño de la Estante.

Para asegurarse de que tiene suficiente tornillos y tuercas, los extras se han incluido.

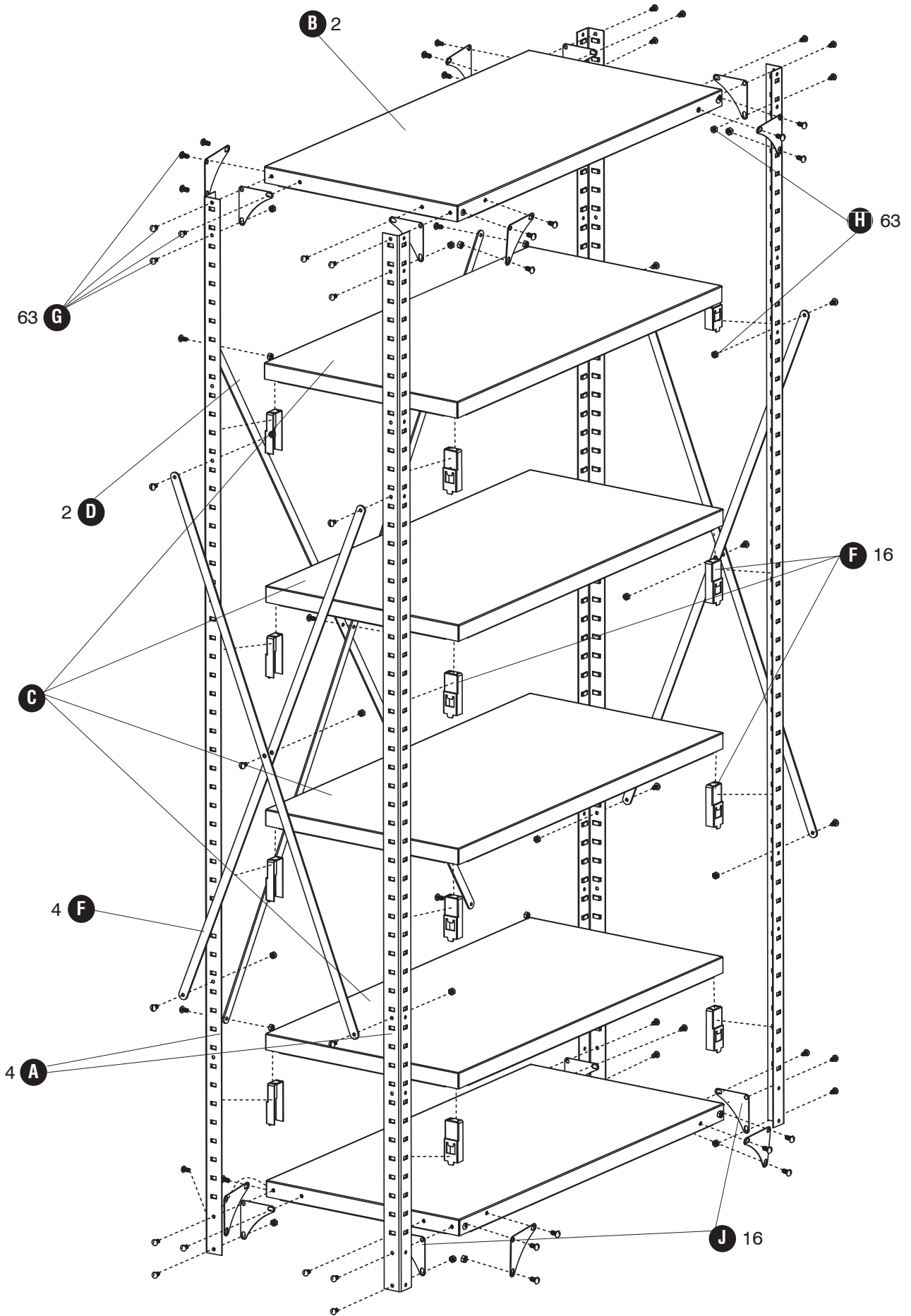

- 1** **G**  24
- H**  24
- I**  4
- J**  8

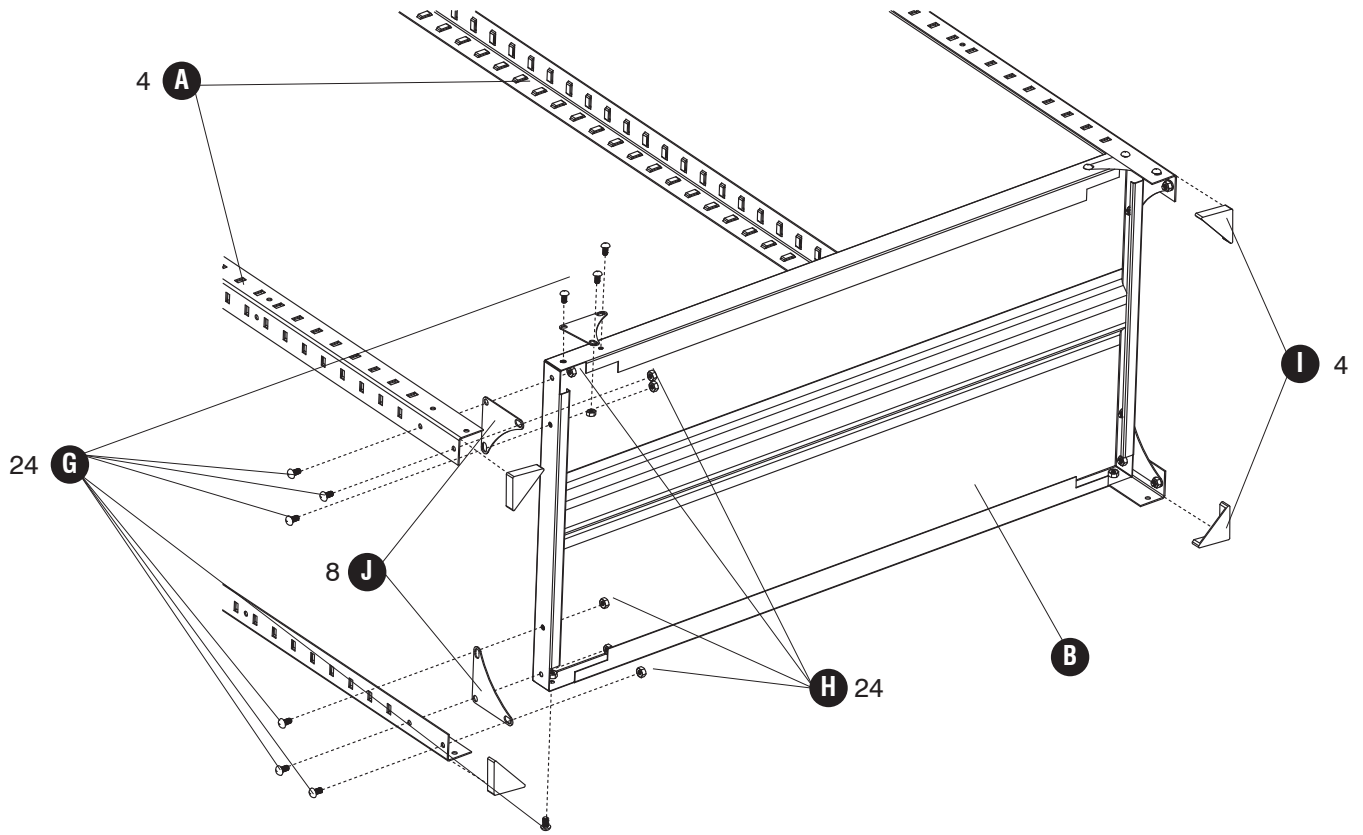

- 2** **G**  24
- H**  24
- J**  8

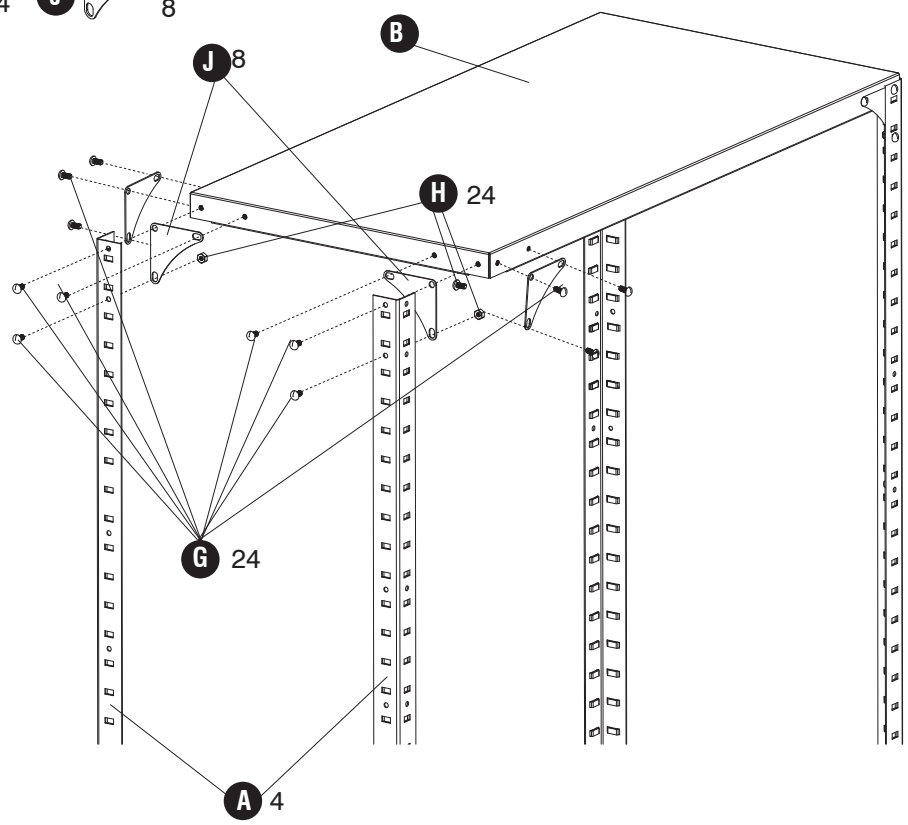

3 **G** 15 **H** 15

NOTE: Refer to the chart below for placement of braces on the different size shelving units.

NOTER: Consultez le tableau ci-dessous pour le placement des renforts sur la différents taille des étagères.

NOTA: Consulte la tabla de abajo para la colocación de soporte para el tamaño de diferentes estanterías

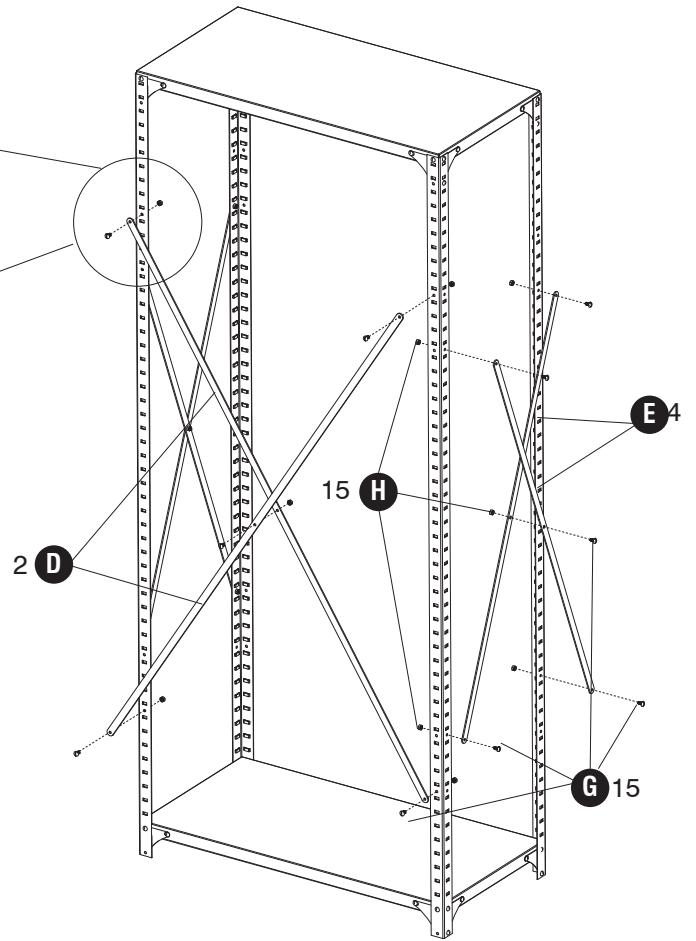
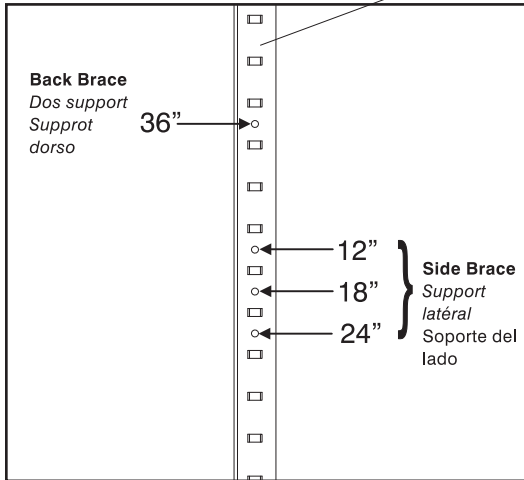

4

