

ASSEMBLY INSTRUCTIONS

INSTRUCTIONS DE MONTAGE • INSTRUCCIONES DE ENSAMBLAJE

TOOLS REQUIRED: Hammer, Allen Wrench (included)

PRODUCT WARRANTY REGISTRATION is available online at: www.safcoproducts.com

• **OUTILS REQUIS :** Le marteau,
Clef Allen (a inclus)

• **HERRAMIENTAS REQUERIDAS:** Martillo,
La llave hexagonal (incluido)





• **LA GARANTIE DU PRODUIT** est
disponible sur l'Internet : www.safcoproducts.com

• **LA GARANTÍA DEL PRODUCTO** está
disponible en la Internet: www.safcoproducts.com

PARTS LIST / LISTE DES PIÈCES / LISTA DE PIEZAS

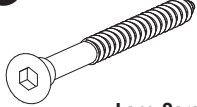
CODE / CODIGO	DESCRIPTION / DESCRIPTION / DESCRIPCIÓN	QTY. / QUANTITÉ / CANTIDAD	PART NO. / N° DE PIÈCE / NO. DE PIEZA
(A)	Back Panel / Panneau arrière / Tablero Trasero	1	3045-53PT
(B)	Left Side Panel / Panneau latéral gauche / Panel del lado izquierdo	1	3045-57PT
(C)	Right Side Panel / Panneau latéral droit / Panel del lado derecho	1	3045-58PT
(D)	Bottom Panel / Panneau inférieur / Tablero del Fondo	1	3083-51NC
(E)	Front Panel / Panneau Avant / Tablero Delantero	1	3045-52PT
(F)	Rectangular Partition / Partition Rectangulaire / Partición Rectangular	1	3045-56PT
(G)	Triangular Partition / Partition Triangulaire / Partición Triangular	3	3045-59PT
(H)	Open Channel / Canal Ouvert / Canal Abierto	1	3083-74PT
(I)	Closed Channel / Canal Fermé / Canal Cerrado	3	3083-73PT
(J)	Hardware Pack / Paquet matériel / Paquete material	1	3083-69PT

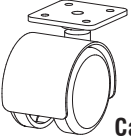
HARDWARE PACK / PAQUET MATÉRIEL / PAQUETE MATERIAL 3083-69PT

 Long Screw <i>Longue Vis</i> Tornillo Largo QTY: 10 #3030-58NC	 Screw Cover <i>Couvercle pour les vis</i> Tapa para los tornillos QTY: 10 #3030-72PT
 Allen Wrench <i>Clef Allen</i> Llave Allen QTY: 1 #3030-83NC	 Caster <i>Roulette</i> Ruedita QTY: 4 #3082-86NC
 Short Screw <i>Courte Vis</i> Tornillo Corto QTY: 16 #3082-84NC	

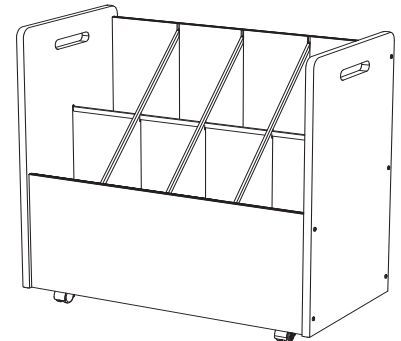
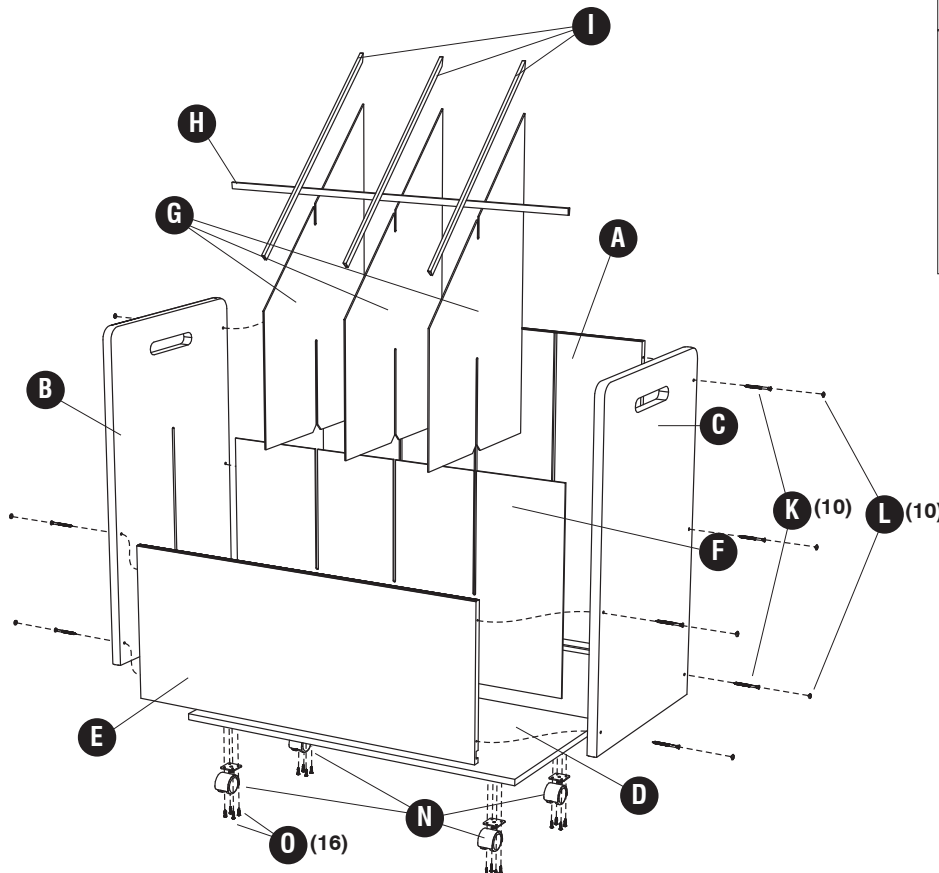

L'Assistance téléphonique à la clientèle Safco au 1-800-664-0042
de 7H30 à 17H00 (Heure centrale) (Opérateurs de langue anglaise)

Línea directa para el cliente de Safco 1-800-664-0042
de 7:30 AM a 5:00 PM (Hora Central) (Operadores que hablan inglés)

