

ASSEMBLY INSTRUCTIONS

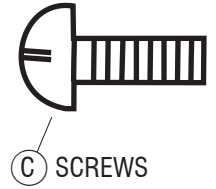

PARTS LIST					
LETTER CODE	DESCRIPTION	QTY.	PART NO.		
(A)	Side Panel	2	4995-01	4997-01	4999-01
(B)	End Panel	2	4995-02	4997-02	4999-02
(C)	Screw	8	4995-23		
(D)	Hex Nut	8	4995-24		

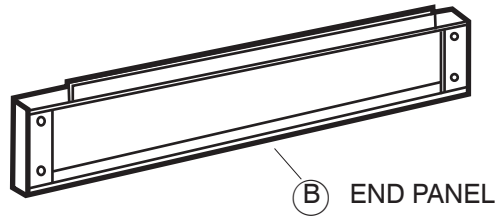
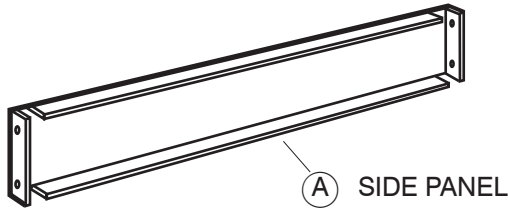
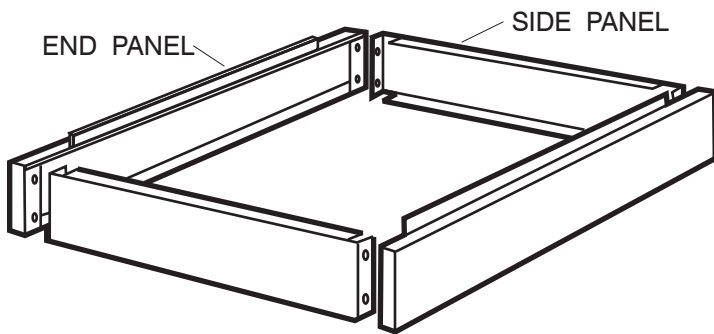

1 Place panels as shown above.

2 Align holes, insert screws. Attach nuts and tighten. Repeat for other corners.

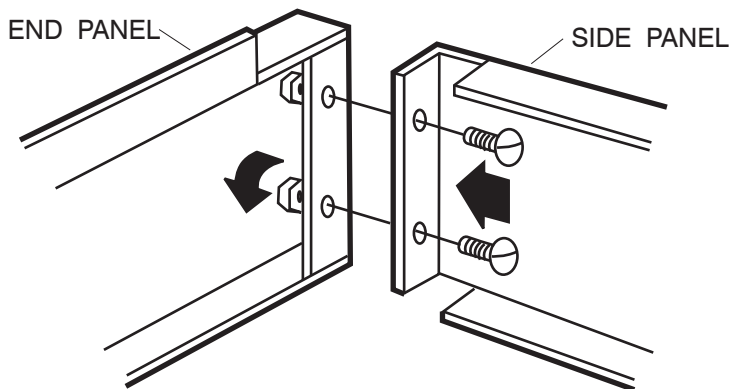

3 With drawers removed, lower cabinet onto base until it locks in place.

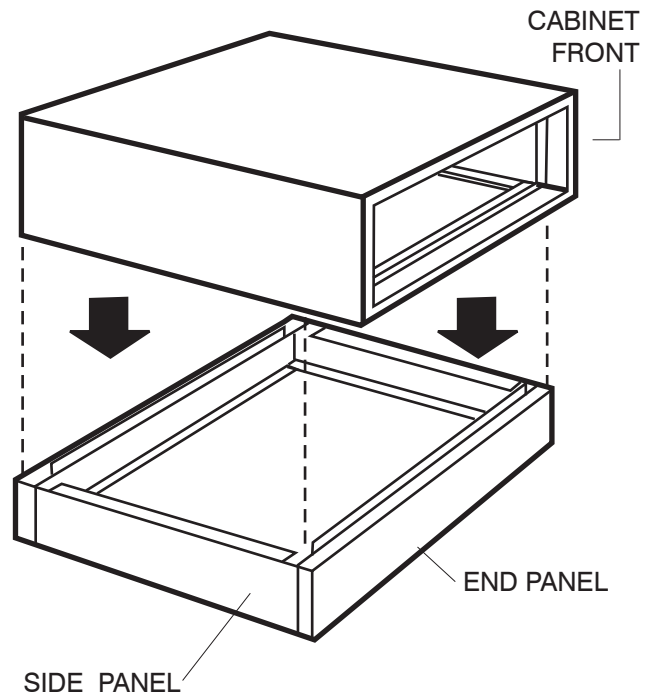

For questions or concerns, please call
Safco Consumer Hot Line 1-800-664-0042
 available Monday-Friday 7:30 AM to 5:00 PM
 (Central Time)
 (English-speaking operators)