

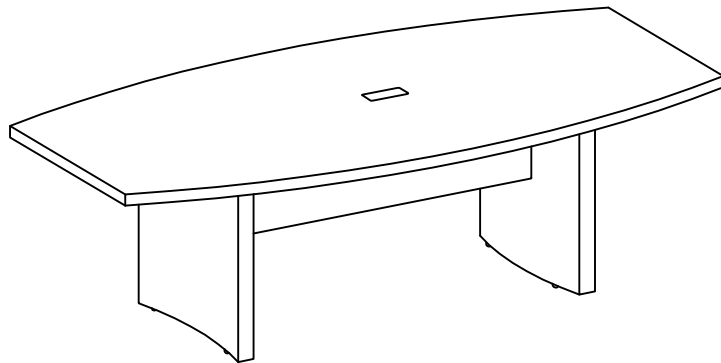





Aberdeen Series™
 Conference Table 72" x 36"
 Model No. ACTB6

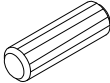

ASSEMBLY INSTRUCTIONS

CALL 1-800-822-8037 FOR ASSISTANCE

PARTS LIST

| Name | Part | Qty. | Spare Qty | Name | Part | Qty. | Spare Qty |
|----------|---|-----------|-----------|----------|---|----------|-----------|
| A |  REALS004 Wood Dowel | 8 | 2 | E |  REALS099 Grommet | 1 | |
| B |  REALS003 Cam Post | 18 | 2 | F |  REALS067 Leveler | 4 | |
| C |  REALS001 Cam Fastener | 18 | 2 | |  ACTBHB | | |
| D |  REALS102** Cam Sticker | 18 | 2 | | | | |

Items with HB are in hardware box.
 **Denotes Color Code

PARTS LIST

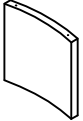
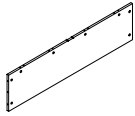
| Name | Part | Qty. | Name | Part | Qty. |
|----------|---|----------|----------|---|----------|
| J |  ABT6** Top | 1 | L |  A6LG** Table Leg | 2 |
| K |  ACTB6K** Modesty Panel | 2 | | | |

IMPORTANT!

Review ALL instructions before beginning assembly . These instructions are provided to avoid problems that may occur from improper assembly or installation. Mayline and/or its distributor are not responsible for failure resulting from improper assembly or installation of this product. Moreover, all warranties are void for failure to follow these assembly instructions.

**Denotes Color Code

2

- 1** **DO NOT** assemble table with top to floor. Table must be assembled in an upright position only.
- 2** Insert Wood Dowels (A) and Cams (C) into Modesty Panels (K). Install Cam Posts (B) into threaded inserts in Table Legs (L). Insert Cams (C) and install Levelers (F) into Table Legs (L). Secure Modesty Panels (K) to Table Legs (L) by turning Cams (C).

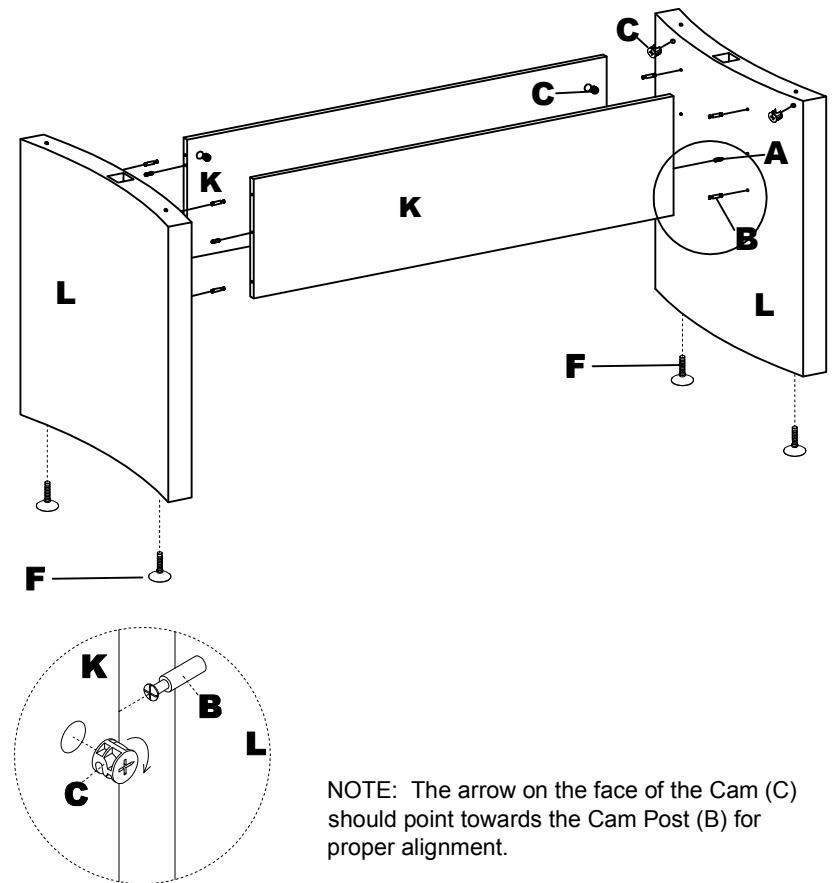

NOTE: The arrow on the face of the Cam (C) should point towards the Cam Post (B) for proper alignment.

3

3

Insert Wood Dowels (A) into the top of the Table Legs (L) and Modesty Panels (K). Insert Cams into the Modesty Panels (K). Install Cam Posts (B) into threaded inserts in the underside of the Top (J). Secure Top (J) to Modesty Panels (K) by turning Cams (C). Apply Cam Stickers (D) to exposed Cams (C). Install Cap and Grommet (E).

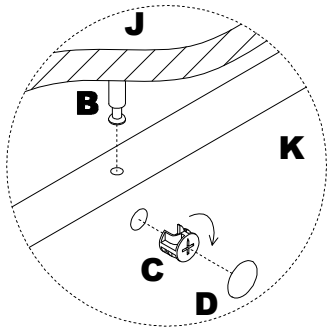
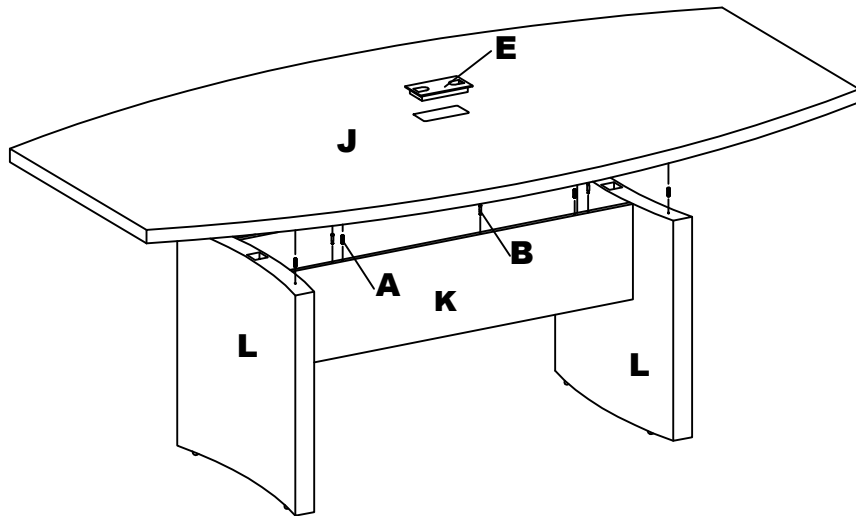

NOTE: The arrow on the face of the Cam (C) should point towards the Cam Post (B) for proper alignment.