

realoffice

MAYLINE

Aberdeen Series™
 Freestanding Lateral File 36"
 Model No. AFLF36

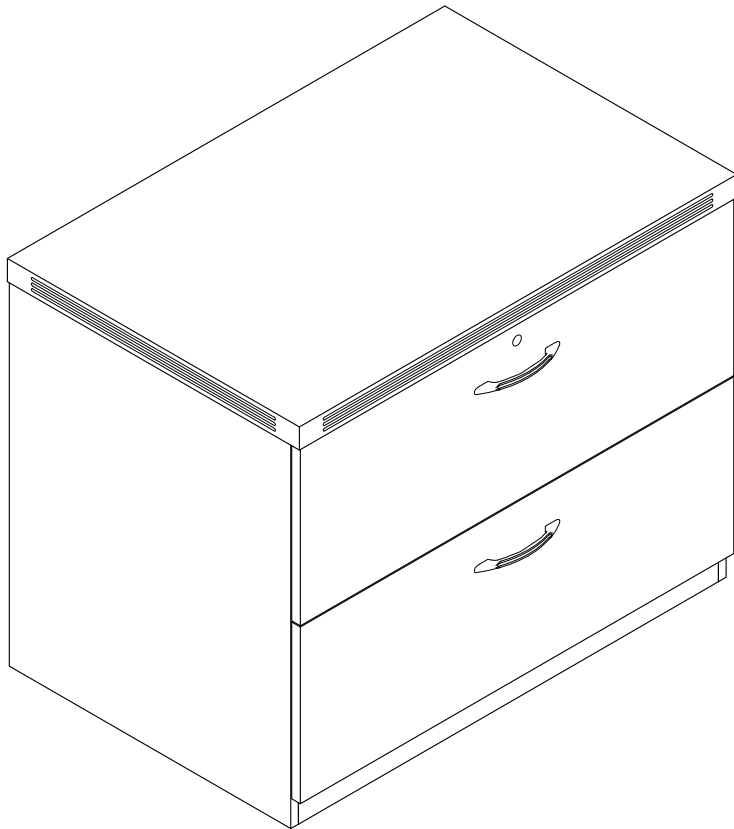

ASSEMBLY INSTRUCTIONS
CALL 1-800-822-8037 FOR ASSISTANCE

P/N **AFLF36** REV 06 07/17/14

PARTS LIST

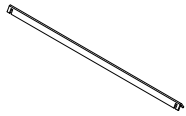
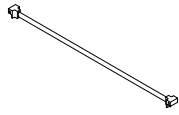
Name	Part	Qty.	Spare Qty
A	 REALS138 File Hanging Bar	2	
B	 REALS208 1 Bar w/2 Caps	4	

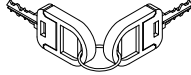
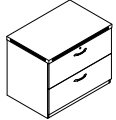
Name	Part	Qty.	Spare Qty
C	 Key	1	
D	 AFLF36** Lateral File	1	

**Denotes Color Code

1

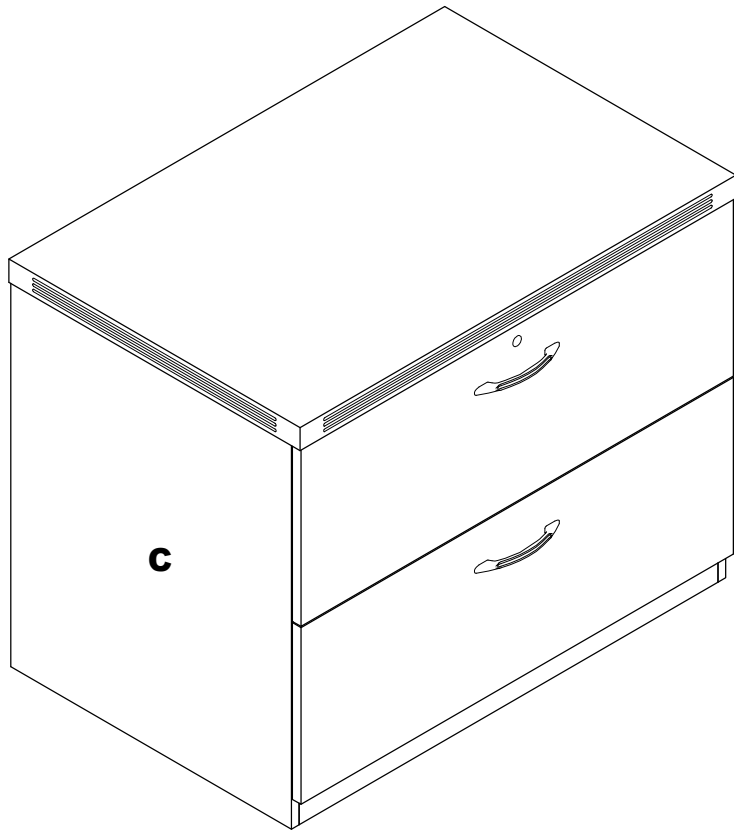

2

2

Arrange File Hangers (B or C) for filing preference.

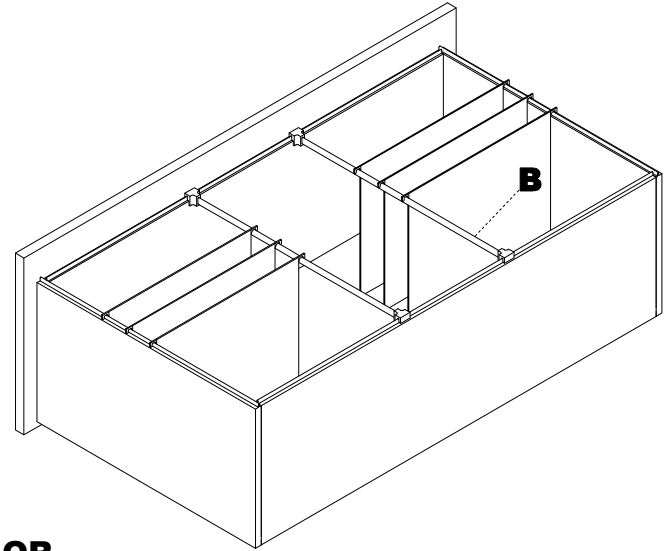

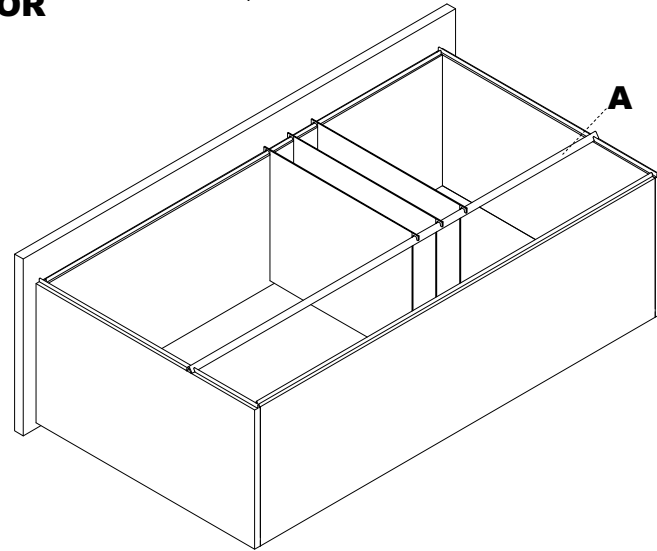

OR

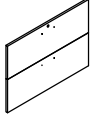
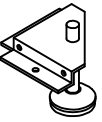
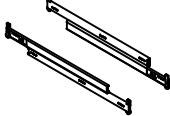
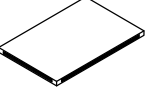

3

Pre-Installed Replacement Parts List

Part	Included Qty.	Part	Included Qty.
 REALS191 Handle	2	 ALF36** Drawer Fronts - Set of 2	1*
 REALS008 Corner Bracket w/ Glide	4	 REALS246 [Ⓜ] Drawer Slide 20" - Pair	2
 AFLF36TOP** Top	1*	 REALS005 Ø4 x 16mm Corner Bracket Screws	24
 REALS121 Ø3 x 14mm Drawer Slide Screws	32	* Available in Cherry (LCR) or Mocha (LDC) finish only. **Denotes Color Code	

A Previous drawer slide was REALS055. Change effective 1/19/08.