

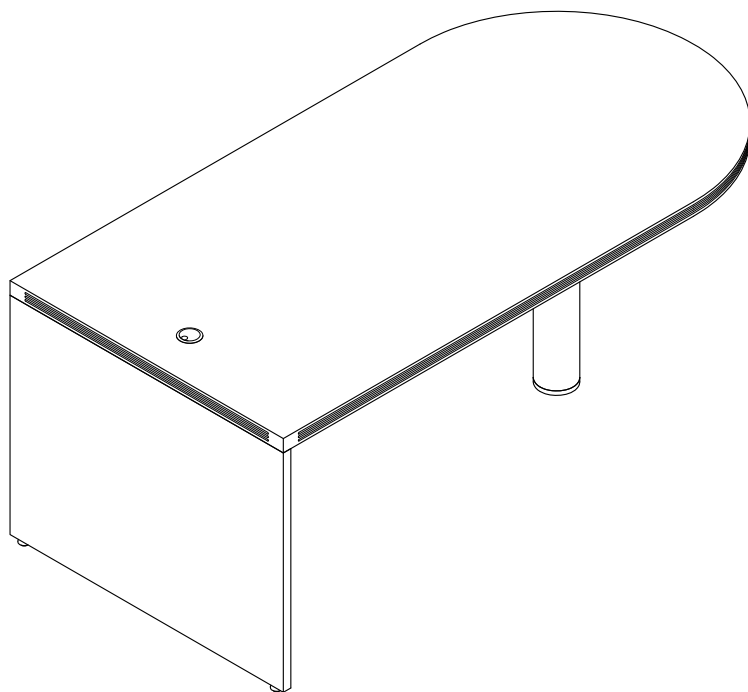





Aberdeen Series™

Freestanding Peninsula 72" x 36"  
Model No. APT7236

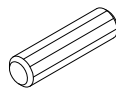
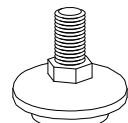
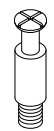

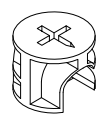
ASSEMBLY INSTRUCTIONS  
CALL 1-800-822-8037 FOR ASSISTANCE

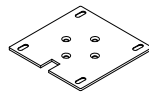
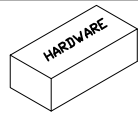
# PARTS LIST

Name	Part	Qty.	Spare Qty	Name	Part	Qty.	Spare Qty
<b>A</b>	 <b>REALS004</b> Wood Dowel	<b>6</b>	<b>1</b>	<b>E</b>	 <b>REALS067</b> Leveler	<b>2</b>	
<b>B</b>	 <b>REALS003</b> Cam Post	<b>11</b>	<b>1</b>	<b>F</b>	 <b>REALS100</b> Grommet	<b>1</b>	
<b>C</b>	 <b>REALS001</b> Cam Fastener	<b>11</b>	<b>1</b>	<b>G</b>	 <b>REALS043</b> Ø6 x 15mm	<b>8</b>	<b>1</b>
<b>D</b>	 <b>REALS102**</b> Cam Sticker	<b>11</b>	<b>1</b>	<b>H</b>	 <b>REALS164</b> Plate For Leg	<b>1</b>	
	 <b>APTHB</b> Items with HB are in hardware box			<b>J</b>	 <b>REALS165</b> Metal Leg	<b>1</b>	

# PARTS LIST

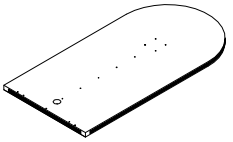
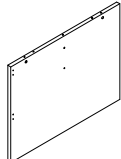
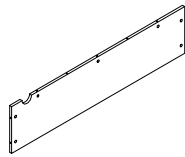
Name	Part	Qty.	Name	Part	Qty.
<b>K</b>	 <b>APT7236K**</b> Top	<b>1</b>	<b>L</b>	 <b>APT36L**</b> End Panel	<b>1</b>
			<b>M</b>	 <b>APT72M**</b> Modesty Panel	<b>1</b>

Item with HB are in hardware box.  
\*\*Denotes Color Code

**2**

**1** Attach Plate (H) to Leg (J) using Screws (G).

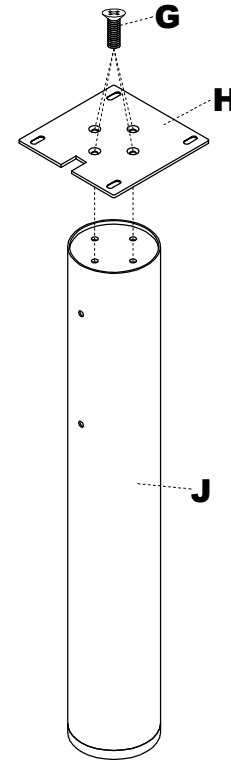

**3**

- 2** Install Cam Posts (B) into End Panel (L) and Leg (J). Insert Wood Dowels (A) into End Panel (L) and Modesty Panel (M). Install Levelers (E) into bottom of End Panel (L). Fasten End Panel (L), Modesty Panel (M) and Leg (J) together by turning Cams (C).

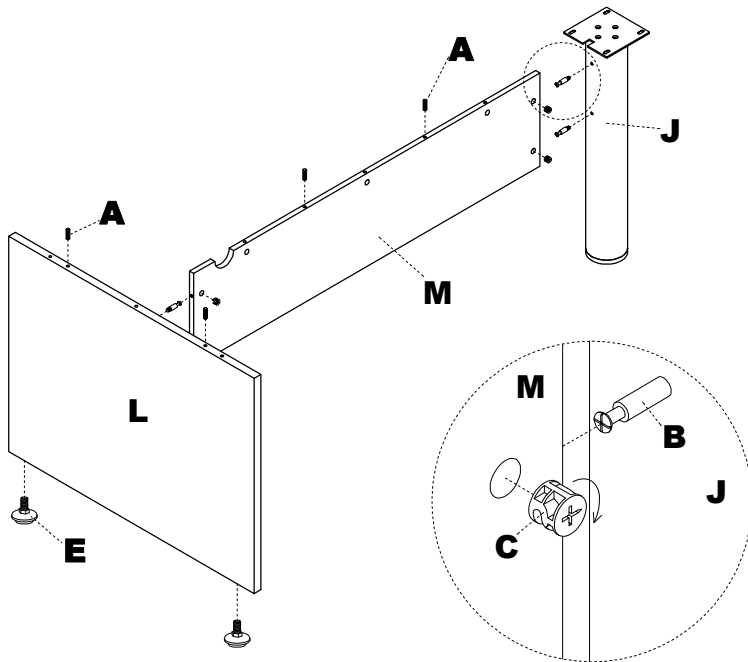

NOTE: The arrow on the face of the Cam (C) should point towards the Cam Post (B) for proper alignment.

**4**

- 3** Install Cam Posts (B) into underside of Top (K).

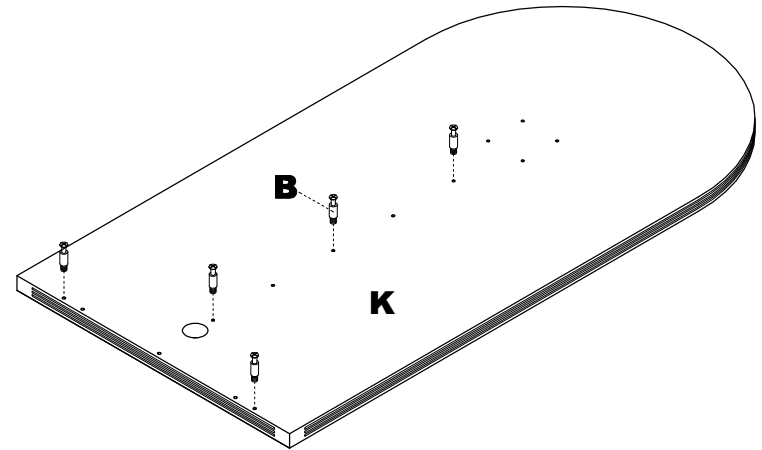

**5**

- 4** Place Top (K) onto base assembly and lock in place by turning Cams (C). Fasten leg assembly to Top (K) using Screws (G). Apply Cam Stickers (D) onto Cams (C) and insert Grommet (F) into Top (K).

