

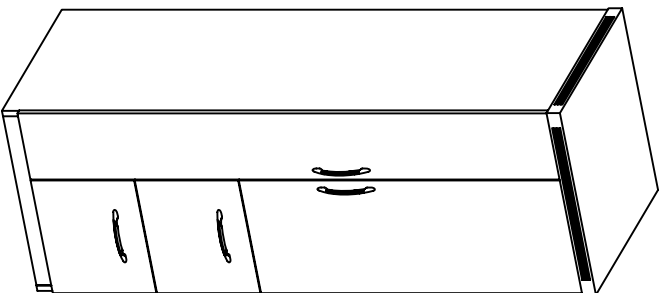















# Aberdeen® Series Personal Storage Tower Model No. APST



## ASSEMBLY INSTRUCTIONS

CALL 1-800-822-8037 FOR ASSISTANCE







# PARTS LIST







Name	Part	Qty.	Spare Qty	Name	Part	Qty.	Spare Qty
<b>A</b>	<b>REALS004</b> Wood Dowel 	<b>26</b>	<b>3</b>	<b>G</b>	<b>REALS173</b> Garment Bar 	<b>1</b>	
<b>B</b>	<b>REALS003</b> Cam Post 	<b>25</b>	<b>2</b>	<b>H</b>	<b>REALS230**</b> Cap 	<b>4</b>	
<b>C</b>	<b>REALS001</b> Cam Fastener 	<b>25</b>	<b>2</b>	<b>I</b>	<b>REALS008</b> Plate with Leveler 	<b>4</b>	
<b>D</b>	<b>REALS102**</b> Cam Sticker 	<b>25</b>	<b>2</b>	<b>J</b>	<b>REALS005</b> Ø4mm*16mm 	<b>24</b>	<b>2</b>
<b>E</b>	<b>REALS172</b> Garment Bar Support 	<b>2</b>		<b>K</b>	<b>REALS009</b> Shelf Pin 	<b>24</b>	<b>3</b>
<b>F</b>	<b>REALS017</b> Ø4mm*16mm 	<b>4</b>	<b>1</b>	<b>L</b>	<b>REALS191</b> Handle w/ Screws 	<b>2</b>	
					<b>APSTHB</b> 		

Items with HB are in hardware box.

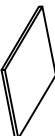
\*\*Denotes Color Code

# PARTS LIST

Name	Part	Qty.
<b>O</b>	Top 	<b>1</b>
<b>P</b>	Left Side Panel 	<b>1</b>
<b>Q</b>	Right Side Panel 	<b>1</b>
<b>R</b>	Center Board 	<b>1</b>
<b>S</b>	Bottom Panel 	<b>1</b>
<b>T</b>	Toe Kick 	<b>1</b>
<b>U</b>	Fixed Shelf 	<b>1</b>

Name	Part	Qty.
<b>V</b>	Large Shelf 	<b>2</b>
<b>W</b>	Small Shelf 	<b>4</b>
<b>X</b>	Back Panel 	<b>1</b>
<b>Y</b>	Left Door 	<b>1</b>
<b>Z</b>	Right Door 	<b>1</b>
<b>A1</b>	Drawers - Set of 2 	<b>2</b>

**2**

## IMPORTANT!

**Review ALL instructions before beginning assembly.** These instructions are provided to avoid problems that may occur from improper assembly or installation. Safco and/or its distributor are not responsible for failure resulting from improper assembly or installation of this product. Moreover, all warranties are void for failure to follow these assembly instructions.

**1**

Insert Dowels (A) into Toe Kick (T). Insert Dowels (A) from Toe Kick (T) into Bottom Panel (S). Install Garment Bar Support (E) to Left Side Panel (P) and Center Panel (R) using Screws (F).

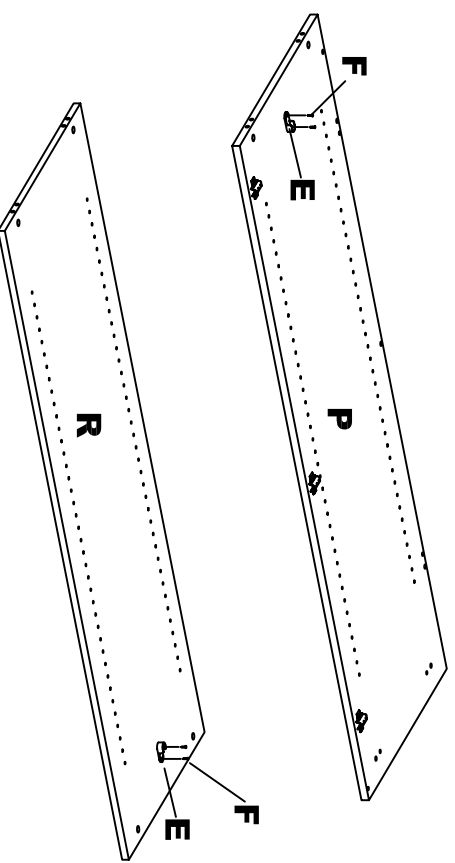
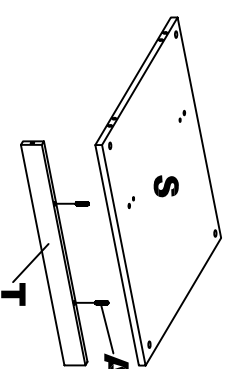

**3**

**2**

Install Cam Posts (B) into threaded Inserts in the Bottom Panel (S). Insert Dowels (A) and Cams (C) into Center Panel (R). Position Center Panel with Grommet Bar Support (E) UP. Attach the Center Panel (R) to the Bottom Panel (S) by turning Cams (C).

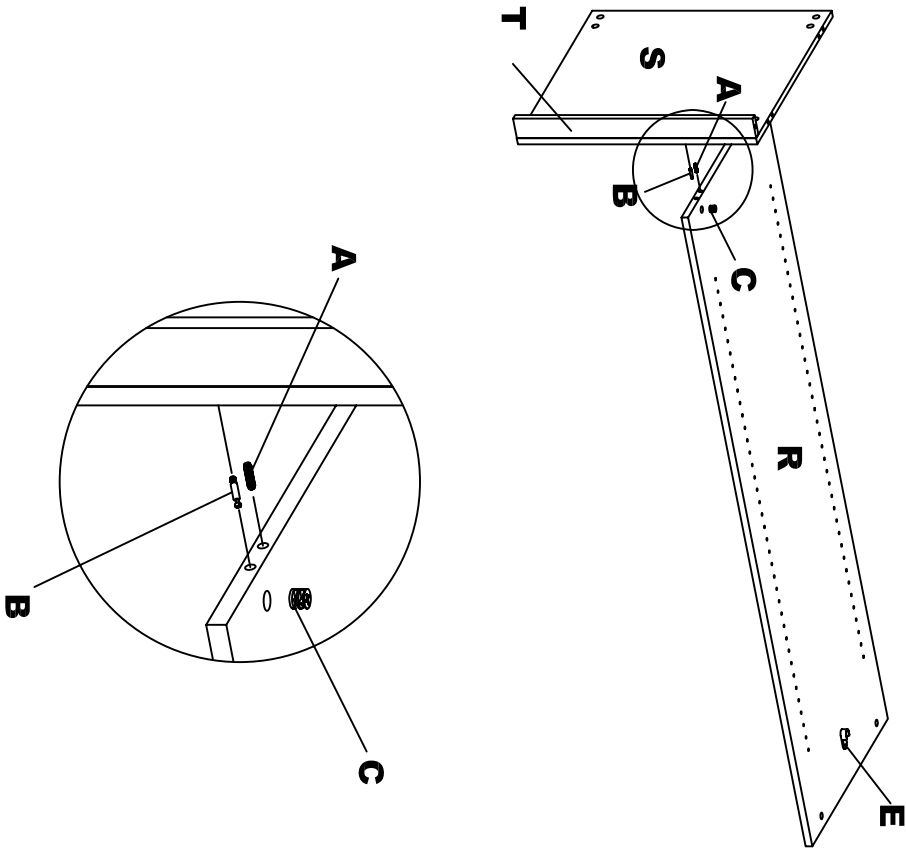

**NOTE:** The arrow on the face of the Cam (C) should point towards the Cam Post (B) for proper alignment.

**4**

**3**

Insert Dowels (A) and Cams (C) into Bottom Panel (S) and Fixed Shelf (U). Install Cam Posts (B) into threaded Inserts in Right Side Panel (Q) and Center Panel (R). Attach Fixed Shelf (U) and Right Side Panel (Q) to Bottom Panel (S) and Center Panel (R) by turning Cams (C).

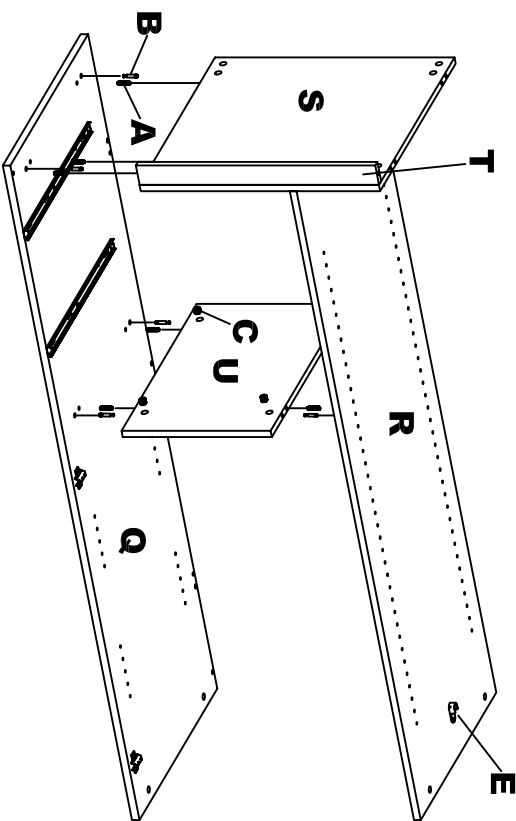

**5**

**4**

Install Cam Posts (B) into threaded inserts in Right and Left Side Panels (P, Q). Insert Dowels (A) and Cams (C) into Back Panel (X) and Bottom Panel (S). Attach Back Panel (X) and Left Side Panel (P) to Right Side Panel (Q) and Bottom Panel (S) by turning Cams (C).

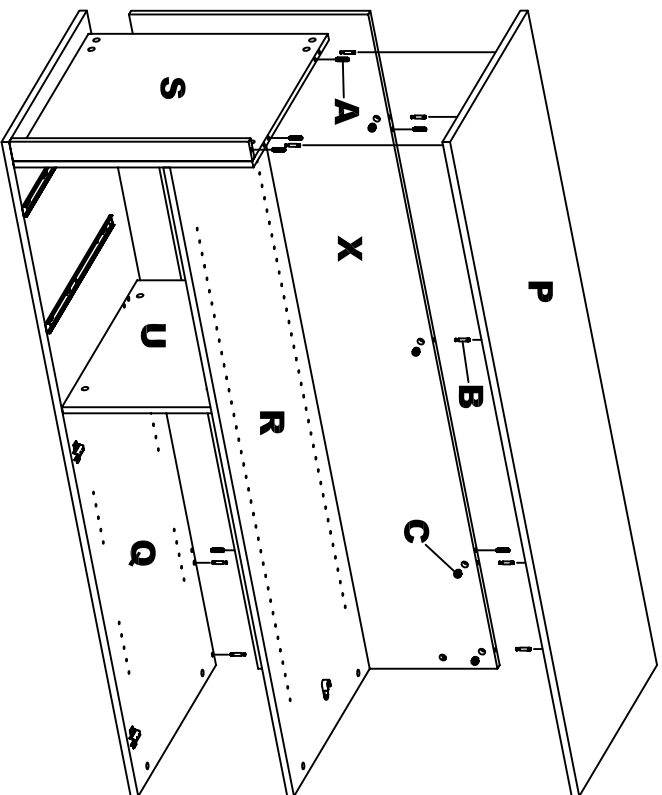

**6**

**5**

Install Plate with Leveler (I) to the bottom of cabinet using Screws (J). Insert Garment Bar (G) into Garment Bar Supports (E). Insert Dowels (A) and Cams (C) into Left and Right Side Panels (P, Q) and Back Panel (X). Install Cam Posts (C) into threaded inserts in the underside of the Top (O). Attach Top (O) to the Left and Right Side Panels (P, Q) and Back Panel (X) by turning Cams (C).

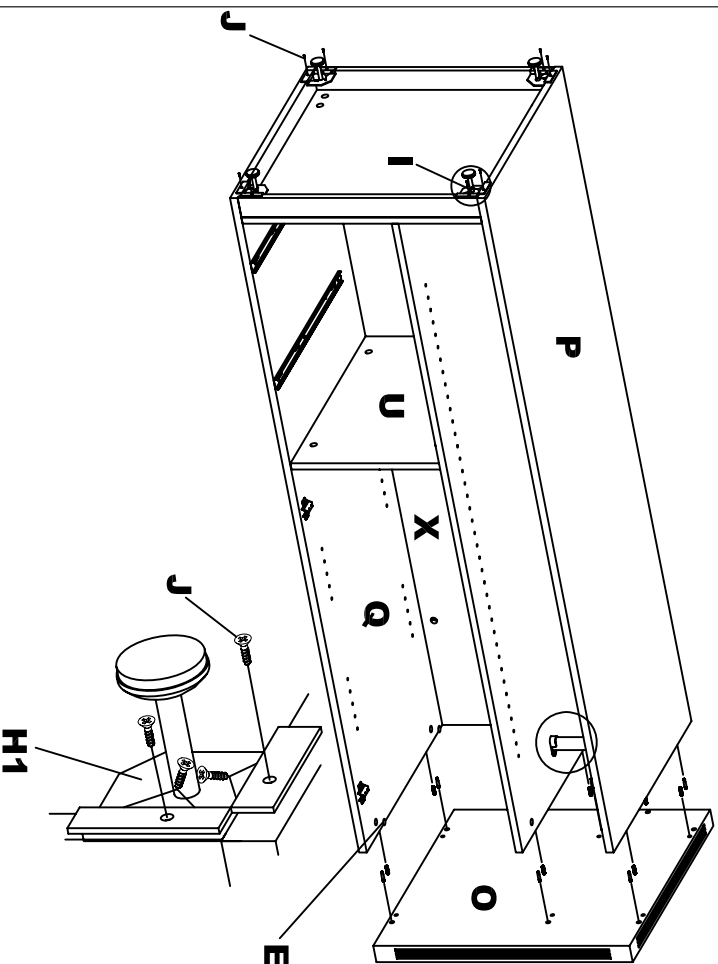
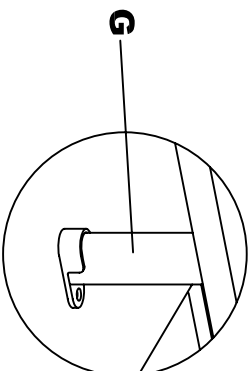

**7**

**6**

Insert Shelf Pins (K) into Left and Right Side Panels (P, Q) and Center Panel (R) in the desired position. Install Shelves (V, W) onto Shelf Pins (K).  
Apply Cam Stickers (D) over exposed Cambs (C). Insert Caps (H) into adjustment holes for levelers.

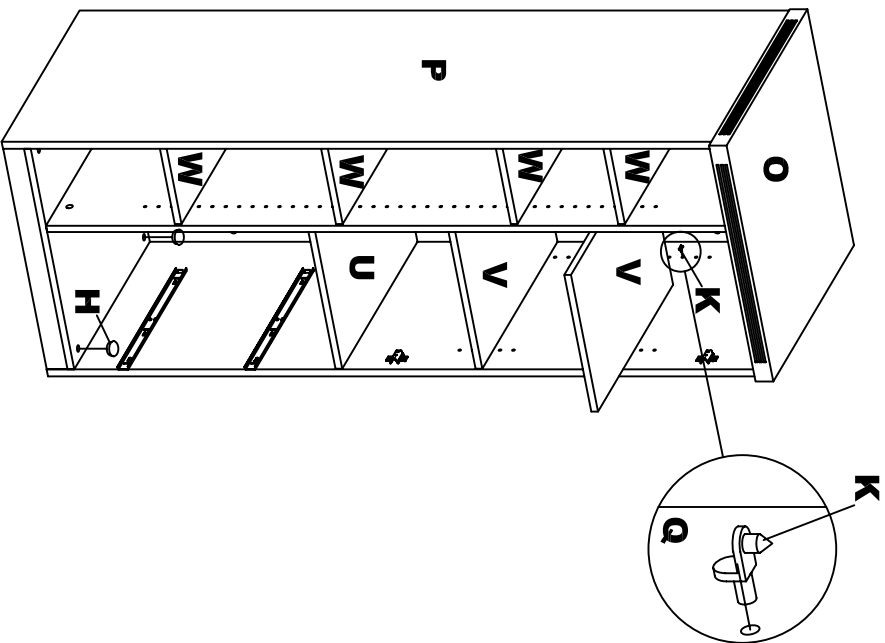

**8**

**7**

Attach Handles (L) to Doors (Y, Z) using screws supplied with Handle.  
Install Doors (Y, Z) onto cabinet.  
Adjust doors for alignment as necessary by using the adjustment screws on the hinges. DO NOT use Power Driver to make these adjustments.

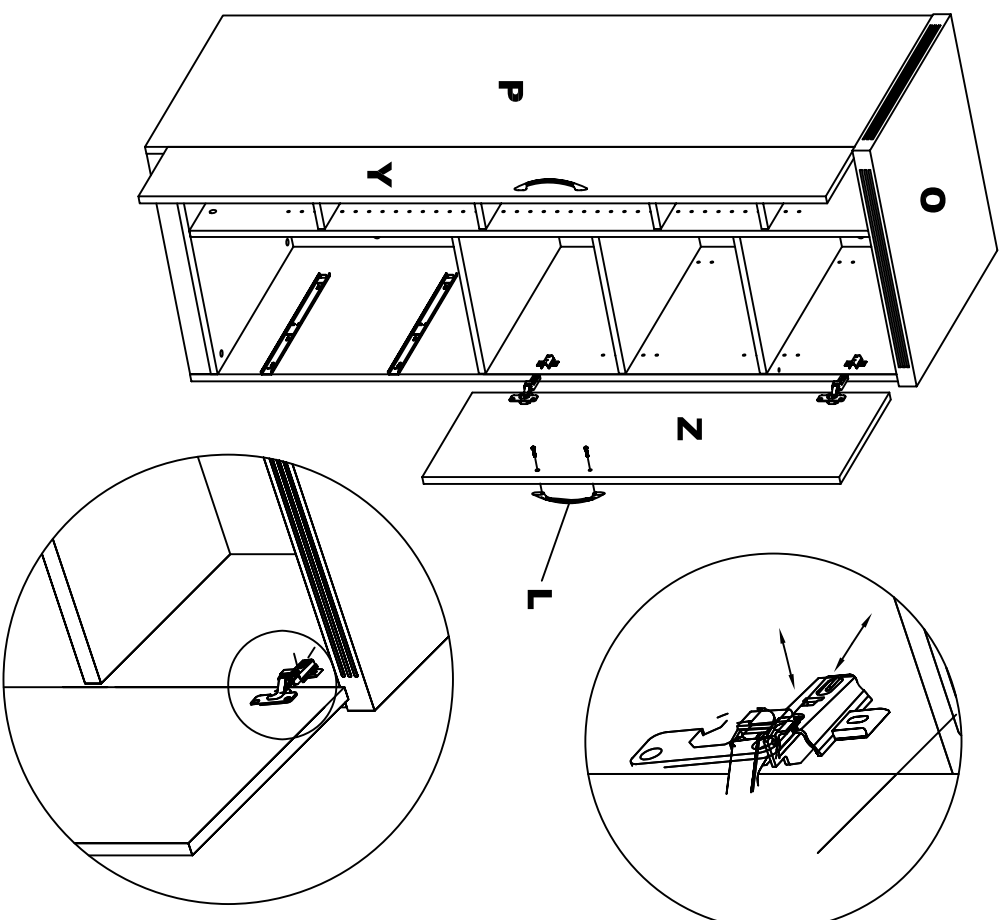





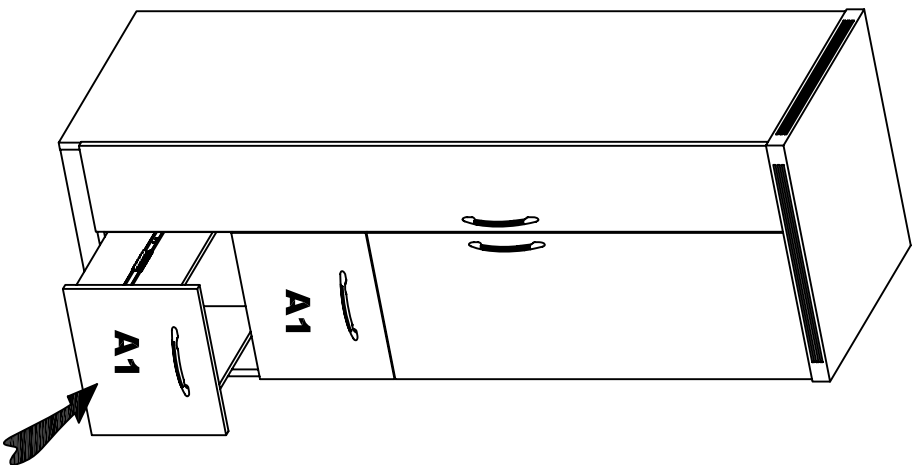

**9**

**8**

Install Drawers (A1) into cabinet by extending the slides in the cabinet and then aligning the grooves in the slide on the drawer with the grooves in the extended slides.

**10**

# Pre-Installed Replacement Parts List

Part	Included Qty.	Part	Included Qty.
 <b>REALS013</b> Hinge - Straight	<b>5</b>	 <b>REALS013P</b> Hinge Plate - Short	<b>5</b>
 <b>REALS018</b> Ø4 x 14mm	<b>20</b>	 <b>REALS055</b> Drawer Slide - Short Pair	<b>2</b>
 <b>REALS191</b> Handle w/ Screws	<b>2</b>	 <b>REALS247</b> Bumper	<b>4</b>
 <b>REALS121</b> Ø3 x 14mm	<b>32</b>		

**11**