

MEDINA[®]

LAMINATE SERIES

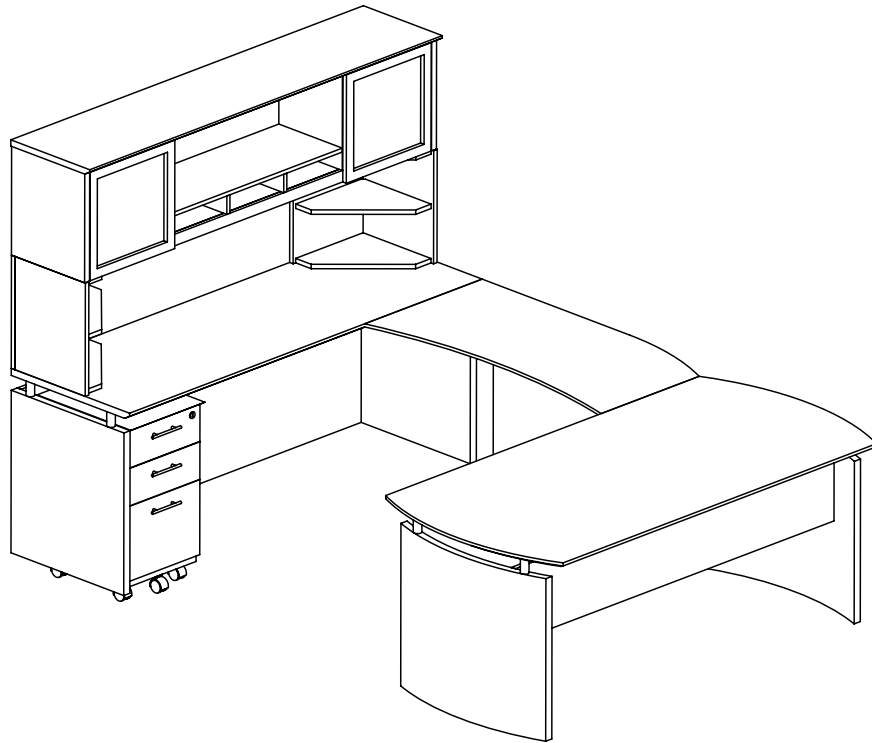

MEDINA DESK SYSTEM

Laminate Options: Gray Steel-LGS, Mocha-LDC and Textured Sea Salt-TSS.

CARB Compliant: Core materials comply with Phase 2 of CARB's formaldehyde emission limits of composite wood materials.

- All Desk, Return and Extension work surfaces are 1" thick with a distinctive beveled edge
- All locks are keyed-alike and feature removable cores for installing "keyed-different" locks after-market
- PVC edge
- All floor supported models include steel threaded leveling glides.
- Models in all finishes are available on both the Quick Ship and Freight delivery programs with no quantity limitations
- Recommended under-cabinet LED Task Light is model EZDP. Other LED Task/Desk lighting is available in the Ergonomics section page 149

CURVED DESK

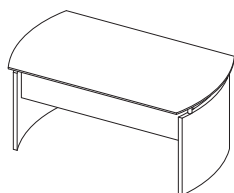

- Floating Top with Silver supports
- Silver modesty panel
- Curved end panels reflect curved ends of work surface

| Model No. | Dimensions | Weight | List Price |
|-----------|---------------------------------|--------|------------|
| MND72 | 72"W x 36"D x 29½"H Curved Ends | 132 | 898.00 |

CURVED DESK RETURN WITH PENCIL/BOX/FILE PEDESTAL

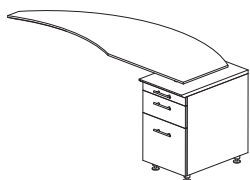

- Works only with MND63 and MND72
- Creates L-shaped work surface when attached to Desk
- Gang-lock features removable core
- Available for right or left side of Desk
- Supported by Return Pencil-Box-File Pedestal
- Stands off on Silver legs

| Model No. | Description | Dimensions | Weight | List Price |
|-----------|------------------|---------------------|--------|------------|
| MNRTPR | 63" Right Return | 63"W x 24"D x 29½"H | 119 | 961.00 |
| MNRTPL | 63" Left Return | 63"W x 24"D x 29½"H | 119 | 961.00 |

CURVED DESK EXTENSION

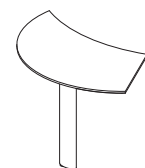

- Works only with MND63 and MND72
- Available for right or left side of Desk
- Supported by Silver stand offs

| Model No. | Description | Dimensions | Weight | List Price |
|-----------|-----------------|---------------------|--------|------------|
| MNEXTR | Right Extension | 47"W x 28"D x 29½"H | 49 | 544.00 |
| MNEXTL | Left Extension | 47"W x 28"D x 29½"H | 49 | 544.00 |

BRIDGE

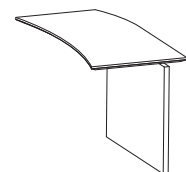

- Works only with MND63 and MND72
- Not free standing. Requires connection to Credenza and Desk
- Features modesty panel

| Model No. | Description | Dimensions | Weight | List Price |
|-----------|-------------------|---------------------|--------|------------|
| MNBDGR | Right Hand Bridge | 48"W x 24"D x 29½"H | 62 | 450.00 |
| MNBDGL | Left Hand Bridge | 48"W x 24"D x 29½"H | 62 | 450.00 |

CREDENZA

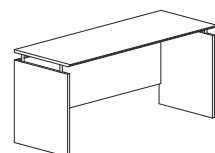

| Model No. | Dimensions | Weight | List Price |
|-----------|---------------------|--------|------------|
| MNCN272 | 72"W x 20"D x 29½"H | 110 | 584.00 |

Note: Credenza can be used with both the Curved Desks and Straight Desks.

HUTCH 

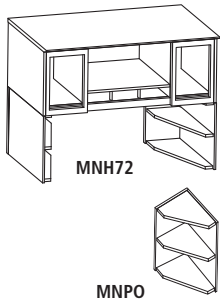

- Frosted glass doors with Silver frames
- Two open compartment slots
- Fully assembled
- Wall mounted or sits on corner supports
- Two corner supports are needed to support a hutch

| Model No. | Description | Dimensions | Weight | List Price |
|-----------|----------------|---------------------|--------|------------|
| MNH63 | 63" Hutch | 63"W x 15"D x 18¼"H | 128 | 894.00 |
| MNH72 | 72" Hutch | 72"W x 15"D x 18¼"H | 132 | 1,040.00 |
| MNPO * | Corner Support | 15"W x 15"D x 20"H | 33 | 146.00 |

* Two corner supports are needed to support a hutch.

Note: Hutchs can be used with both the Curved Desks and Straight Desks.

STRAIGHT DESK 

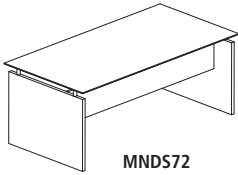

- Floating Top with Silver supports
- Silver modesty panels

| Model No. | Dimensions | Weight | List Price |
|-----------|--------------------------------|--------|------------|
| MND563 | 63"W x 36"D x 29½"H, Rectangle | 128 | 852.00 |
| MND572 | 72"W x 36"D x 29½"H, Rectangle | 132 | 898.00 |

TABLE DESK 

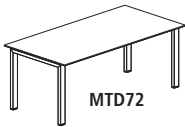

- No grommets
- Silver Base

| Model No. | Description | Dimensions | List Price |
|-----------|------------------------------|---------------------|------------|
| MTD72 | Table Desk with Straight Top | 72"W x 36"D x 29½"H | 954.00 |

UNIVERSAL RETURN 

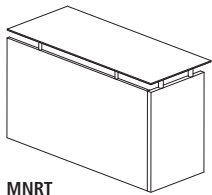

- Works only with MND563 and MND572
- Creates L-shaped work surface when attached to Desk
- Full modesty panel

| Model No. | Description | Dimensions | Weight | List Price |
|-----------|-------------------|----------------------|--------|------------|
| MNRT | Non-Handed Return | 48½"W x 20"D x 29½"H | 119 | 461.00 |

NON-HANDED STRAIGHT BRIDGE 

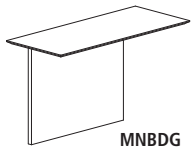

- Works only with MND563 and MND572
- Not free standing. Requires connection to Credenza and Desk
- Features modesty panel

| Model No. | Description | Dimensions | Weight | List Price |
|-----------|----------------------------|----------------------|--------|------------|
| MNBDG | Non-Handed Straight Bridge | 48½"W x 20"D x 29½"H | 62 | 450.00 |

Medina™ Height-Adjustable Bridge 

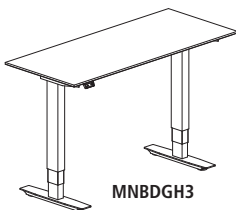

- Return includes (1) 3-Stage ML-Series Height-Adjustable Base with (1) pair of 18" feet with brackets
- Modesty Panel cannot be used when using the Height-Adjustable Base
- **Laminate Options:** Gray Steel-LGS, Mocha-LDC, Textured Sea Salt-TSS
- Freestanding unit; not attached to Credenza and Desk
- Leave 1" clearance on each side between Desk or Credenza and Bridge when assembled to allow table to move free of obstruction

| Model No. | Description | Dimensions | Weight | List Price |
|-----------|--|----------------------------|--------|------------|
| MNBDGH3 | 48" Non-Handed Straight Bridge with 3-Stage Height-Adj. Base | 48"W x 20"D x 24½" to 50"H | 127 | 1,649.00 |

MOBILE PEDESTALS

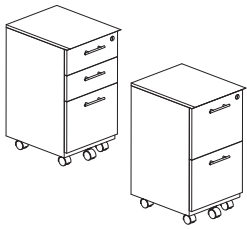

- Accommodate letter sized hanging file folders only
- Drawers operate smoothly using full-extension ball-bearing suspensions
- Fits under Credenzas
- 2" dual-hooded casters

| Model No. | Description | Dimensions | Weight | List Price |
|-----------|--------------|----------------------|--------|------------|
| MNBBF | Box/Box/File | 15½"W x 18"D x 26¾"H | 70 | 590.00 |
| MNFF | File/File | 15½"W x 18"D x 26¾"H | 68 | 544.00 |

CENTER DESK DRAWER

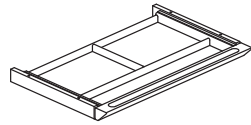

- Solid wood frame construction
- Drawer operates smoothly using full-extension ball-bearing suspension
- Available in Graphite with Black drawer front only

| Model No. | Dimensions | Weight | List Price |
|-----------|--|--------|------------|
| ACD | 25"W x 18"D x 2"H | 13 | 227.00 |
| ACDS30 | 25"W x 12½"D x 2"H Use with 30"D Height-Adjustable Desks | 13 | 224.00 |

LATERAL FILE

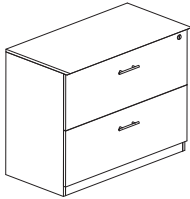

- Accommodates letter- and legal-sized hanging file folders
- Includes counter-weight for stability when in use
- Gang-lock features removable core enabling keyed-alike suites
- Drawers operate smoothly using full-extension ball-bearing suspensions

| Model No. | Description | Dimensions | Weight | List Price |
|-----------|-------------------|-------------------------------|--------|------------|
| MVLF | File/File Lateral | 36"W x 20"D x 29½"H Assembled | 180 | 1,122.00 |

LOW WALL CABINET WITH DOORS

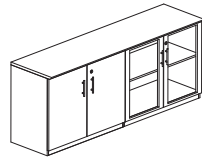

- Sets of doors lock separately. Keyed alike
- Includes one adjustable shelf on each side

| Model No. | Description | Dimensions | Weight | List Price |
|-----------|-----------------------------|---------------------|--------|------------|
| MVLC | Wood/Glass Door Combination | 72"W x 20"D x 29½"H | 190 | 1,305.00 |

STORAGE CABINET

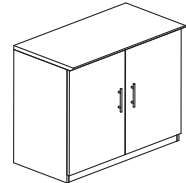

- Self-closing hinged doors
- One (1) shelf adjustable on 1¼" increments
- Mouse hole in back panel for wall access
- Shelf contains corner mouse hole for vertical cable management

| Model No. | Description | Dimensions | Weight | List Price |
|-----------|-----------------|---------------------|--------|------------|
| MSC | Storage Cabinet | 36"W x 20"D x 29½"H | 96 | 930.00 |

BOOKCASES

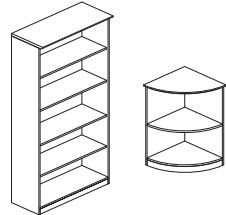

- Open shelves for convenient storage
- Choice of two or five shelf units
- Adjustable shelves
- 1" thick shelves
- MVB5 supports 75 lbs. per shelf, evenly distributed
- MVBQ2 supports 25 lbs. per shelf, evenly distributed

| Model No. | Description | Dimensions | Weight | List Price |
|-----------|-------------------|---------------------|--------|------------|
| MVB5 | 5 Shelf | 36"W x 13"D x 68"H | 145 | 785.00 |
| MVBQ2 | 2 Shelf ¼ - Round | 20"W x 20"D x 29½"H | 36 | 289.00 |

REPLACEMENT LOCK CORES



- Allows pedestals and laterals to be keyed uniquely for up to ten different workstations
- Master key available
- Must purchase a core removal tool to change locks cores

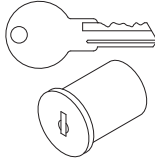

| Model No. | Description | Weight | List Price |
|--|----------------------------|--------|------------|
| REALCC0311 through REALCC0325 (Silver) | Replacement Core with Keys | 1 | 30.00 |
| REALCRK | Core Removal Tool | 1 | 30.00 |
| REALCMK | Master Key | 1 | 30.00 |

MEDINA CONFERENCE TABLES



Laminate Options: Gray Steel-LGS, Mocha-LDC and Textured Sea Salt-TSS

- Cutout designed to support PM33 listed below
- 250 lb. weight capacity
- Grommet hole cutout size is 4 x 8"
- Conference table legs have cable chimney for concealed cable management from surface to floor



MNCR48

| Model No. | Description | Dimensions | Weight | List Price |
|-----------|------------------------|-----------------------|--------|------------|
| MNCR48 | Round Conference Table | 48" Diameter x 29½" H | 135 | 799.00 |
| MNC8 | 8' Conference Table | 96"W x 42"D x 29½" H | 236 | 1,470.00 |
| MNC10 | 10' Conference Table | 120"W x 48"D x 29½" H | 306 | 2,007.00 |
| MNC12 | 12' Conference Table | 144"W x 48"D x 29½" H | 358 | 2,403.00 |
| MNC14 | 14' Conference Table | 168"W x 48"D x 29½" H | 399 | 2,798.00 |
| MNPB | Presentation Board | 48"W x 48"H x 3¼"D | 110 | 904.00 |

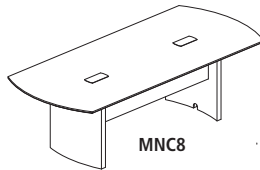

MNC8

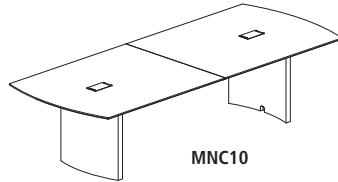

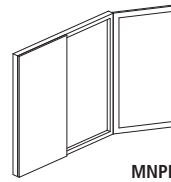

MNC10

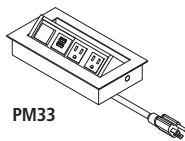

MNPB



PM33

| Model No. | Description | Weight | List Price |
|--|--|--------|------------|
| PM33    | Power and USB Module with two Power and two USB Outlets (Black-BLK or Silver-SLV) add suffix BLK or SLV after model number (example: PM33BLK) Outside dimension: 8.33"w x 4.40"d, Inside: 6.60"w x 2.75"d | 4 | 792.00 |

MEDINA RECEPTION FURNITURE



Laminate Options: Gray Steel-LGS, Mocha-LDC and Textured Sea Salt-TSS

- Universal Return
- ¾" frosted, tempered glass
- All Reception Station typicals include a center drawer

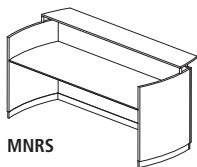

MNRS

| Model No. | Description | Dimensions | Weight | List Price |
|-----------|--|--|--------|------------|
| MNRS | Reception Station (No Pedestals) | 87¼"W x 37¼"D x 42¾"H | 360 | 3,689.00 |
| MNRSBF | Reception Station with Box/Box/File, File/File | 87¼"W x 37¼"D x 42¾"H | 520 | 4,826.00 |
| MNRSBFB | Reception Station with Return, Box/Box/File, File/File | 87¼"W x 37¼"D x 42¾"H Desk 48"W x 25"D x 39¼"H Return | 882 | 5,804.00 |
| MNRBBF | Reception Box/Box/File (Pedestal only) | 15½"W x 18"D x 27½"H | 77 | 590.00 |
| MNRFF | Reception File/File (Pedestal only) | 15½"W x 18"D x 27½"H | 75 | 544.00 |

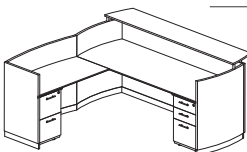

MNRSBFB



MEDINA™ HEIGHT-ADJUSTABLE FRONT DESKS

- Desks easily adjust from 29½ - 49¼"
- All work surfaces are 1" thick with a distinctive beveled edge and Silver detail
- All pieces coordinate with Medina™ Desking, Conference and Reception Furniture
- Drive System 110V, 60Hz AC input 120V DC motor draws a maximum of 3 amps for quick and easy movement
- Moves at a speed of ¾" per second for quick adjustment
- Control Switch has simple Up/Down Buttons; sold as standard for ease of reconfiguration
- **Laminate options:** Gray Steel-LGS, Mocha-LDC, Textured Sea Salt-TSS

Medina™ Height-Adjustable Straight Front Desk 

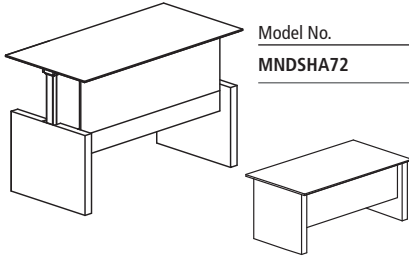

| Model No. | Description | Dimensions | Weight | List Price |
|-----------|-------------------------|---------------------------|--------|------------|
| MNDSHA72 | 72" Straight Front Desk | 72"W x 36"D x 29½ - 49¼"H | 257 | 2,439.00 |

SKINNY PEDESTAL   

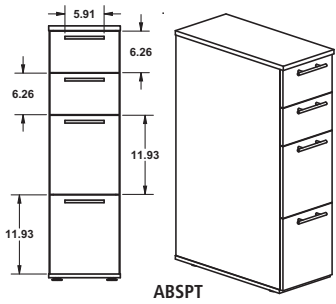

| Model No. | Description | Dimensions | Weight | List Price |
|-----------|------------------------|----------------------|--------|------------|
| ABSP | Skinny Pedestal | 10¾"W x 23"D x 25½"H | 53 | 445.00 |
| ABSPT | Skinny Pedestal (Tall) | 10¾"W x 23"D x 38½"H | 82 | 556.00 |

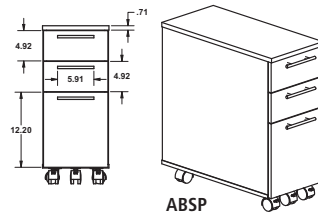

- Front 3 casters are 2" high locking casters
- Available in Medina™ laminate colors

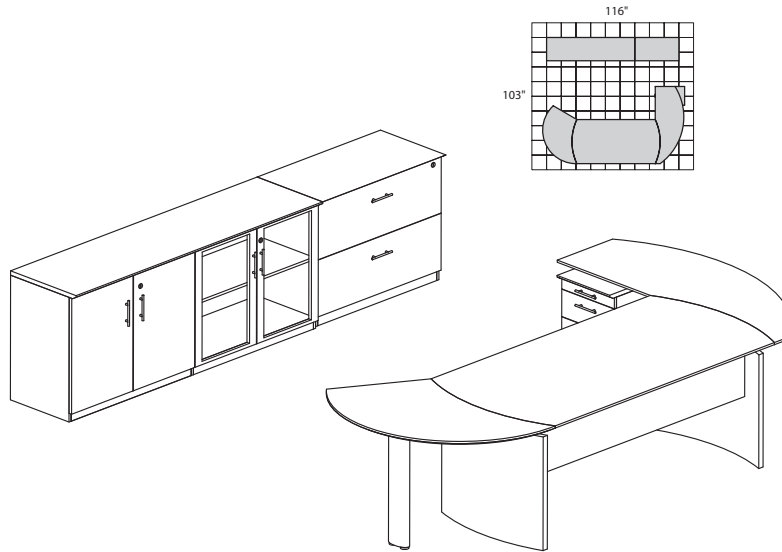

MEDINA SERIES – IDEA STARTER #1

Consists of:

| QTY. | MODEL NO. | DESCRIPTION | LIST PRICE EACH |
|------|-----------|--|-----------------|
| 1 | MND72 | 72"W Desk | 898.00 |
| 1 | MNEXTR | Curved Desk Extension | 544.00 |
| 1 | MNRTPL | Curved Desk Return with P/B/F Pedestal | 961.00 |
| 1 | ACD | Center Drawer | 227.00 |
| 1 | MVLC | Low Wall Cabinet | 1,305.00 |
| 1 | MVLF | Lateral File | 1,122.00 |
| | | | 5,057.00 |

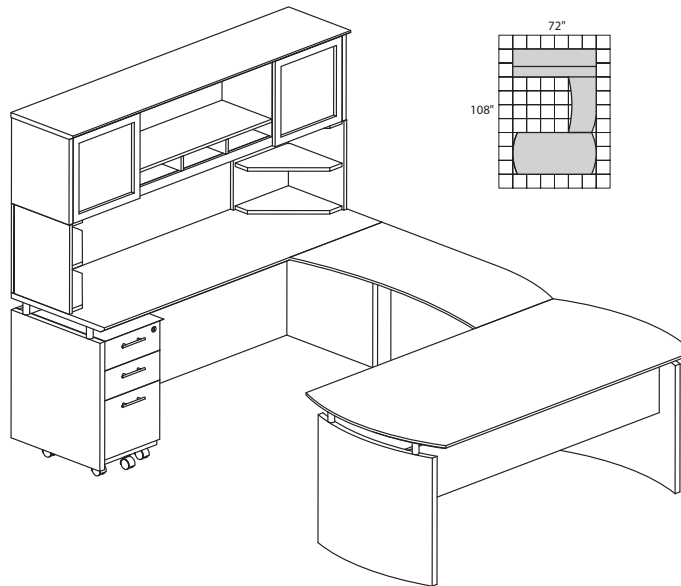

MEDINA SERIES – IDEA STARTER #2

Consists of:

| QTY. | MODEL NO. | DESCRIPTION | LIST PRICE EACH |
|------|-----------|-----------------------|-----------------|
| 1 | MND72 | 72"W Desk | 898.00 |
| 1 | ACD | Center Drawer | 227.00 |
| 1 | MNBDGL | Bridge Left-Hand | 450.00 |
| 1 | MNCNZ72 | 72"W Credenza | 584.00 |
| 1 | MNH72 | 72"W Hutch | 1,040.00 |
| 1 | MNBBF | Box/Box/File Pedestal | 590.00 |
| 2 | MNPO | Corner Supports | 146.00 |
| | | | 4,081.00 |